



GRACE Science Team Meeting

October 8-10, 2003



Compiled by
J. Ries and S. Bettadpur
Center for Space Research
The University of Texas at Austin

CSR-GR-04-01



Table of Contents

Agenda

Attendees/Invitees

Reports of Splinter Groups

Summaries of Research

All Presentations

Agenda

WED, Oct 8, 2003 – Project Status

0800 – 0900 : Registration & Coffee

0900 – 1230 : AM Session

- **Welcome & Introductory Remarks**
- **Overview: Status of Science** Tapley/Reigber
 - o Mission Description & Goals
 - o Overview of mission quality – Mean & Variability
 - o Plans for near future & data release plans
- **Project Status & Near Term Plans**
 - o Flight Segment & Occultations Status Davis
 - o Ground Segment & Operations Beerer
 - o Mission Profile Bettadpur
- **The Science Data Processing**
 - o SDS Organization, Roles & Responsibilities Watkins
 - o Level-1
 - Data flow & Level-1 Processing Description Kruizinga
 - Level-1 Backup & SLR Analysis Flechtner
 - o Level-2
 - Level-2 Processing Description Nagel
 - Level-2 Data Products Bettadpur
 - o Archive & Data Distribution
 - PO.DAAC Finch
 - ISDC Flechtner

1230 – 1330 : Lunch

- **Mission Flight Profile & Data Quality**
 - o Assessments of data quality – instruments & products
 - KBR/GPS/SCA Bertiger
 - ACC Bettadpur
 - o In-flight Calibrations Kruizinga
 - o Other resources available for data users Kruizinga
- **Assessment of Gravity Field Products**
 - o Gravity Field Ries/Schmidt
 - Error assessments – accuracy versus resolution
 - Comparison of “current” products to earlier release
- **Special Topics**
 - o Validation Plans & Status Watkins
 - o The AOD1B Product Flechtner
 - o Aliasing & De-Aliasing Thompson
 - o Comments of gravity field product quality Wahr/Zlotnicki
- **ICESat Mission Status** Schutz
- **Definition of Splinter Groups & Moderators**

THU Oct 9, 2003 – Science Investigations by Themes

(Talks are not in necessarily in order of presentation)

0830 - 1030

- ***AM Session-1: Geodesy, Satellite Geodesy, Regional Method & Data Verification***

1. GRACE Geoid & GPS Leveling (Huang, Veronneau – NRCan)
2. ~~Gravity field validation by short arcs of SST (Ilk – ITG Bonn).~~
3. Unique approach to addressing time-variable gravity for GRACE (Lemoine – GSFC).
4. Current & Future satellite mission data analysis for global gravity & reference frame (E Pavlis – U Maryland).
5. Analysis of surface gravity & satellite altimetry data sets for combination with GRACE (N Pavlis – Raytheon).
6. Validation of GRACE Level-2 data products & development of high-resolution regional gravity models (Jekeli – OSU).
7. Integrated sensor analysis for GRACE (Frommknecht, Rummel & Flechtner – TU Munich/GFZ)
8. GRACE accelerometer data evaluation (Balmino, Biancale, Flechtner – GRGS/GFZ)
9. Short & long-term stability of the GRACE USO (Larson – U Colorado)

1043 - 1230

- ***AM Session-2: Global Geodynamics, Geophysics, Solid Earth, & Cryosphere***

1. GRACE, mass displacements & Earth rotation (Gross – JPL)
2. GRACE Validation using Earth rotation & climate models (Chen – U Texas).
3. GRACE Validation (Dickey – JPL)
4. GPS Derived motions of the Earthquake cycle & GRACE gravity changes: case Andes (Klotz, Reigber, Wolf – GFZ)
5. Absolute gravimetry in the Fennoscandian uplift area: validation of GRACE gravity changes (Muller – IFE Hannover).
6. Validation using aero-gravimetry data (Meyer/Reigber – GFZ)
7. Validation of GRACE gravity variations using global superconducting gravimeter network (Neumeyer, Hinderer, Reigber, Crossley – GFZ/EOST)
8. High accuracy gravimetric geoid for arctic research (McAdoo, Childers – NOAA/NRL)
9. Geodetic & geodynamic studies of postglacial rebound in patagonia (Bevis – U Hawaii/Manoa).
10. Geodetic signature of cryosphere change & interaction with lithosphere, mantle & oceans (Ivins – JPL).
11. Canadian PGR, GPS & Grace signatures (Wolf, Galas – GFZ).
12. Ice mass variations & Earth rheology – A global inverse approach (Wu – JPL).

1230 – 1330 – Lunch

1330 – through the bar-b-que

- **PM Session: Earth System Science, Modeling, Geophysical Fluids, Climate Change**

1. Assimilation of Grace models - Exact title to be handed in later (Schröter, AWI)
2. Currents Exact title to be handed in later (Stammer, IFM Hamburg)
3. Ocean Currents & Mass Signals & their impact on gravity & Earth rotation (Wunsch, Stammer, Ponte)
4. Application of GRACE data to improving ocean heat storage estimates from satellite altimetry (Chambers – U Texas).
5. GRACE Applications to Ocean Circulation (Zlotnicki – JPL)
6. Tides for & From GRACE (Ray – GSFC)
7. GRACE & ocean research at POL-UK (Hughes – Proudman Ocn Lab)

atmosphere also

8. Geopotential heights for grace de-aliasing – Comparison of SAC-C, CHAMP & GRACE Occultation data with GCM (Velicogna - Colorado)
9. Separation of GRACE data into atmospheric & oceanic geoid components (Condi – U Texas)
10. Atmospheric mass & motion signals in GRACE & Earth rotation measurements (Salstein – AER).

climate

11. Validation of GRACE: Role of Ice Sheet & Oceanic Mass Variations in global sea level change (Shum – OSU).
12. Constraints on melting, sea-level & paleoclimate from GRACE (Davis – SAO).

hydrology

13. Hydrological & Oceanographic applications of GRACE (Wahr – U Colorado).
14. Global hydrological modelling of changes in the terrestrial water storage - contributions to GRACE validation and signal separation (Güntner; Döll; Reigber; GFZ/Uni Kassel)
15. Terrestrial water storage variations using GRACE: Estimation, Uncertainty & Validation (Famiglietti – UC Irvine).

dedicated campaigns

16. An OBP Validation experiment for GRACE (Send; Schröter; Miller; Reigber; IFM Kiel, AWI, GFZ).
17. Geophysical validation for GRACE Time-Variable Gravity: Two case studies (Chao – GSFC).
18. Validation of GRACE derived fields using data from Japanese Antarctic Research Expedition Area & Syowa Station (Shibuya – NIPR, Japan)

1830 – 2130 – Hill Country Barbeque

Friday Oct 10, 2003 – Splinters, Summary & Future Plans

Session Goals: To establish teaming arrangements in several short term calibration/evaluation areas, to identify opportunities for interacting with other scientific field campaigns; to plan actions to take advantage of any opportunities and to plan for future Science Team meetings.

Splinter Group Meetings

Splinter Meeting Reports

Meeting Summary, Action Items & Future Meeting Plans

Meeting Objectives

- Wed : Project Background & Science Results
 - **Session Goals:** Inform the Science Team about the state of the Project
 - Describe the mission goals & status
 - Describe the science results so far
 - a. Describe the gravity field product quality
 - » Prefaced by product definition
 - » Followed by usage guidelines
 - b. Relation to pre-launch science goals
 - » Minimum Mission
 - » Baseline Mission
 - c. Plans for the Validation Phase
 - d. Emphasize quality of released fields relative to “present-best”
 - To describe the mission profile (past & future)
 - To describe the SDS & Science Data
 - a. SDS roles & responsibilities
 - b. Data flow & data description
 - Special Topics
 - Thu. All Day – Moderated Discussions of Investigator’s Presentations
 - **Session Goals:** To familiarize the science team and the project with the collective scope of work; and to understand the general or specific data/product needs for the investigations.
 - Fri. AM – Splinters, Summary & Future Plans
-

Attendees/Invitees

GRACE Science Team Meeting Attendees/Invitees

Last Name	First Name	Affiliation	E-mail Address
Abusali	P.A.M.	Center for Space Research	abusali@csr.utexas.edu
Alsdorf	Doug	University of California-LA	alsdorf@geog.ucla.edu
Balmino	Georges	GRGS Toulouse	georges.balmino@cnes.fr
Beerer	Joe	Jet Propulsion Laboratory	Joseph.G.Beerer@jpl.nasa.gov
Bender	Peter	University of Colorado Boulder	PBENDER@jila.colorado.edu
Bertiger	William	Jet Propulsion Laboratory	wib@cobra.jpl.nasa.gov
Bettadpur	Srinivas	Center for Space Research	srinivas@csr.utexas.edu
Bevis	Michael	University of Hawaii at Manoa	bevis@soest.hawaii.edu
Bonin	Jenny	Center for Space Research	bonin@csr.utexas.edu
Case	Kelley	Jet Propulsion Laboratory	kelley.case@jpl.nasa.gov
Chambers	Don	Center for Space Research	chambers@csr.utexas.edu
Chang	Edward	Goddard Space Flight Center	edward.s.chang@nasa.gov
Chao	Benjamin	Goddard Space Flight Center	chao@bowie.gsfc.nasa.gov
Chen	Jianli	Center for Space Research	chen@csr.utexas.edu
Cheng	Minkang	Center for Space Research	cheng@csr.utexas.edu
Childers	Vicki	National Research Laboratory	vicki@qur.nrl.navy.mil
Condi	Francis	Center for Space Research	fcondi@csr.utexas.edu
Davis	James	Smithsonian Astrophysical Observatory	jdavis@cfa.harvard.edu
Davis	Edgar	Jet Propulsion Laboratory	ab.davis@mail1.jpl.nasa.gov
Dickey	Jean	Jet Propulsion Laboratory	jean.dickey@jpl.nasa.gov
Eanes	Richard	Center for Space Research	eanes@csr.utexas.edu
Famiglietti	James	University of California Irvine	jfamigli@uci.edu
Finch	Chris	Jet Propulsion Laboratory	chris.finch@jpl.nasa.gov
Flechtner	Frank	GeoForschungsZentrum Potsdam (GFZ)	flechtne@gfz-potsdam.de
Frommknecht	Bjoern	TU Munich	frommknecht@bv.tu-muenchen.de
Gasparovic	Richard	Applied Physics Laboratory	r.gasparovic@huapl.edu
Gross	Richard	Jet Propulsion Laboratory	Richard.Gross@jpl.nasa.gov
Gunter	Brian	Center for Space Research	gunter@csr.utexas.edu
Han	Shin-Chan	Ohio State University	Han.104@osu.edu
Hinderer	Jaques	EOST Strassburg	hinderer@bowie.gsfc.nasa.gov
Hinga	Mark	Center for Space Research	hinga@csr.utexas.edu
Huang	Jianliang	Natural Resources Canada	jianhuan@NRCan.gc.ca
Hughes	Chris	Proudman Oceanographic Laboratories	cwh@pol.ac.uk
Ilk	Karl-Heinz	TU Bonn	ilk@theor.geod.uni-bonn.de
Ivins	Erik	Jet Propulsion Laboratory	eri@fryxell.jpl.nasa.gov
Jakowski	Norbert	Deutsches Zentrum für Luft- und Raumfahrt e.V.	norbert.jakowski@dlr.de
Jayne	Steven	Woods Hole Oceanographic Institute	surje@whoi.edu
Jekeli	Christopher	Ohio State University	jekeli.1@osu.edu
Jeong-Shuler	Harrey	Center for Space Research	jeong@csr.utexas.edu
Kang	Zhigui	Center for Space Research	kang@csr.utexas.edu
Kaye	Jack	NASA Headquarters	jkaye@mail.hq.nasa.gov
Klosko	Steven	Raytheon ITSS Corporation	Steven_M_Klosko@raytheon.com
Knudsen	Per	National Survey & Cadastre (KMS)	pk@kms.dk
Ko	Ung-Dai	Center for Space Research	higrandeur@mail.utexas.edu
Kruizinga	Gerhard	Jet Propulsion Laboratory	Gerhard.Kruizinga@jpl.nasa.gov
LaBrecque	John	NASA Headquarters	John.LaBrecque@nasa.gov
Larson	Kristine	University of Colorado Boulder	Kristine.Larson@colorado.edu
Lemoine	Frank G	Goddard Space Flight Center	flemoine@geodesy2.gsfc.nasa.gov
Luthcke	Scott	Goddard Space Flight Center	sluthcke@geodesy2.gsfc.nasa.gov
Mauldin	Jeff	Center for Space Research	mauldin@csr.utexas.edu
McAdoo	Dave	National Oceanic and Atmospheric Administration	dave.mcadoo@noaa.gov
Melbourne	William	Jet Propulsion Laboratory	wgm@gfz-potsdam.de
Miller	Heinrich	AWI Bremerhaven	hmiller@awi-bremerhaven.de
Morton	Phillip	Jet Propulsion Laboratory	phillip.r.morton@jpl.nasa.gov
Nagel	Peter	Center for Space Research	nagel@csr.utexas.edu
Nerem	Steve	University of Colorado Boulder	nerem@colorado.edu
Pastor	Rick	Center for Space Research	pastor@csr.utexas.edu
Pavlis	Despina	Goddard Space Flight Center	dpavlis@geodesy2.gsfc.nasa.gov
Pavlis	Erricos	University of Maryland - Baltimore Cnty	epavlis@JCET.umbc.edu
Pavlis	Nikolaos	Raytheon ITSS Corporation	npavlis@atlas.stx.com
Pendleton	Shauna	Center for Space Research	pendleton@csr.utexas.edu
Ponte	Rui	Atmospheric and Environmental Research, Inc.	rponte@aer.com
Poole	Steve	Center for Space Research	poole@csr.utexas.edu

GRACE Science Team Meeting Attendees/Invitees

Porter	David	Applied Physics Laboratory	David_Porter@jhuapl.edu
Raschke	Ehrhard	GKSS-Forschungszentrum Geesthacht GMBH	raschke@gkss.de
Ray	Richard	Goddard Space Flight Center	ray@nemo.gsfc.nasa.gov
Reigber	Christoph	GeoForschungsZentrum Potsdam (GFZ)	reigber@gfz-potsdam.de
Ries	John	Center for Space Research	ries@csr.utexas.edu
Rim	Hyung-Jin	Center for Space Research	rim@csr.utexas.edu
Rodell	Matthew	Goddard Space Flight Center	Matthew.Rodell@nasa.gov
Roesset	Peter	Center for Space Research	roesset@csr.utexas.edu
Romans	Larry	Jet Propulsion Laboratory	Larry.J.Romans@jpl.nasa.gov
Rosell	Sheldon	Jet Propulsion Laboratory	Sheldon.N.Rosell@jpl.nasa.gov
Rowlands	David	Goddard Space Flight Center	drowland@heliert.gsfc.nasa.gov
Rummel	Reiner	Technische Universitat Munchen	rummel@bv.tum.de
Sabadini	Roberto	University of Milano	roberto.sabadini@unimi.it
Salstein	David	Atmospheric and Environmental Research Inc	salstein@aer.com
Save	Himanshu	Center for Space Research	save@csr.utexas.edu
Schmidt	Roland	GeoForschungsZentrum Potsdam (GFZ)	rschmidt@gfz-potsdam.de
Schröter	Jens	AWI Bremerhaven	jschroeter@awi-bremerhaven.de
Schutz	Bob	Center for Space Research	schutz@csr.utexas.edu
Schwintzer	Peter	GeoForschungsZentrum Potsdam (GFZ)	psch@gfz-potsdam.de
Seo	Ki-Weon	University of Texas at Austin	kiweon@speer.geo.utexas.edu
Shibuya	Kazuo	National Institute of Polar Research (NIPR)	shibuya@nipr.ac.jp
Shum	C.K.	Ohio State University	ckshum@osu.edu
Song	Tony	Jet Propulsion Laboratory	song@pacific.jpl.nasa.gov
Stammer	Detlef	IfM Hamburg	stammer@ifm.uni-hamburg.de
Swenson	Sean	University of Colorado Boulder	swensosc@lemond.colorado.edu
Tapley	Byron	Center for Space Research	tapley@csr.utexas.edu
Thompson	Paul	Center for Space Research	thompson@csr.utexas.edu
Tsaossi	Lucia	NASA Headquarters	lucia.s.tsaoussi@nasa.gov
Velicogna	Isabella	University of Colorado Boulder	isabella@giove.colorado.edu
Wahr	John	University of Colorado Boulder	wahr@longo.colorado.edu
Wang	Furun	Center for Space Research	wang@csr.utexas.edu
Watkins	Michael	Jet Propulsion Laboratory	Michael.M.Watkins@jpl.nasa.gov
Wilson	Clark	University of Texas at Austin	crwilson@mail.utexas.edu
Wolf	Detlef	GeoForschungsZentrum Potsdam (GFZ)	dasca@gfz-potsdam.de
Woodworth	Phillip	Proudman Oceanographic Laboratory	pwl@pol.as.uk
Wu	Xiaoping	Jet Propulsion Laboratory	Xiaoping.Wu@jpl.nasa.gov
Wu	Sien-Chong	Jet Propulsion Laboratory	Sien-Chong.Wu@jpl.nasa.gov
Wunsch	Carl	Massachusetts Institute of Technology	cwunsch@pond.mit.edu
Yamarone	Charles	Jet Propulsion Laboratory	C.A.Yamarone-Jr@jpl.nasa.gov
Yuan	Dah-Ning	Jet Propulsion Laboratory	Dah-Ning.Yuan@jpl.nasa.gov
Zlotnicki	Victor	Jet Propulsion Laboratory	vz@pacific.jpl.nasa.gov

did not attend

Splinter Meeting Reports

Solid Earth Validation Splinter Group Summary

We do not expect to be able to validate the accuracy of GRACE measurements, but rather to find signals that we can reasonably expect to recognize in the GRACE fields. However, separation of the various different signals that GRACE will measure remains a major problem for validation of the GRACE geoid.

Examples of time variable signals that various working group members suggested we could examine in the GRACE data include:

---Ocean tides at locations where they are sufficiently well known. (There is a problem with this strategy however. The monthly fields from GRACE data will completely alias any mass changes with periods less than 60 days; tides have negligible signal at longer periods. Arguably one could look for aliasing effects of tidal mass changes, but mass predictions of the POP ocean model with periods less than one month are subtracted from the GRACE range-rates in initial processing, in order to reduce the effects of aliasing in the monthly averaged fields. The POP model includes ocean tides.)

---Solid Earth tides were also suggested. (Here again the signals are aliased and negligible at longer periods relative to other signals.)

---Secular signals such as post-glacial rebound. This may be more promising, as one can target specific areas where competing signals are expected to be smaller and where PGR is relatively well-constrained. Examples of such areas include Fennoscandia and northern North America. However, averaging over periods of several years would be necessary to reduce competing signals from seasonal and climatic hydrologic variations.

---The filling of the Three Gorges Reservoir in China. This is also promising, in that it will be a very big signal. However some caution will be required because we still must separate the reservoir filling from other signals. Most notably, the subsurface hydrologic response to reservoir filling might induce a very large mass change (i.e., a significant fraction of the total mass change) and is fundamentally unknown.

---Can compare with SLR estimates of low harmonic geoid change, but it is not clear that signals exceed the SLR uncertainties on monthly timescales of GRACE fields. Comparisons may be valid for much longer timescales of order several years.

---Can also compare with loads derived from Earth rotation and GPS estimates of mass loading response. However, the GPS network is nonuniformly sampled and will contain significant signals at high spatial frequencies that are aliased by poor global network sampling. Vertical GPS position, the most important for this application, still has very large uncertainties due to covariance with parameterization of atmospheric delays; the uncertainties for individual daily measurements are often as large as or larger than the load signals

---Can compare with the GGP gravimetric network dataset. However, spatial sampling by the GGP network is even poorer than that of the GPS network, and gravity measurements are much more sensitive to the local mass variations than is GPS loading response (in fact, surface gravimetric measurements are negligibly affected by surface mass variations at distances >1 km).

Also, gravity partitions various mass signals differently than GRACE: for example, atmospheric mass anomalies are above the instrument, and solid Earth surface deflections by mass loading, tectonics and poroelastic effects will contribute primarily as a free-air gravity change and secondarily due to the change in solid Earth mass. This approach to validation would require a more dense network of gravity stations than the

current GGP deployment. It would also require a means of separating vertical signals from gravity change, by collocating with GPS measurements for example, to leave the mass component for comparison with satellite data.

---Can compare to estimates of snow accumulation. The main problem with this approach lies in verifying the accuracy of the water mass estimates from sparsely distributed gauge measurements.

---Can compare to Amazon basin mass changes, e.g., collaborate with a hydrologist to compare mass changes predicted by a model. This approach would also be very contingent on the ability of the model to accurately reproduce surface water, subsurface hydrology, runoff and evapotranspiration effects from a few sparse measurements.

!---IT IS IMPORTANT TO NOTE THAT NONE OF THESE APPROACHES WILL BE SUITABLE FOR VALIDATION OF GRACE ACCURACY AT WAVELENGTHS RELEVANT TO GRACE MEASUREMENTS, because none of the mass signals can be constrained to GRACE accuracy at large scales.--!!

CAL/VAL of the GRACE data in an area where there are no significant surface mass signals other than the atmospheric mass remains the best option. Among the other signals that may be observed and compared with GRACE results, the most promising target is post-glacial rebound in Fennoscandia. This is the best-measured of the PGR localities, and the secular variation should be clearly recognizable after 5 years of GRACE measurements. Independent observations available in the region include the GPS measurements of the Bi-Frost network, excellent tide gauge coverage (and records). However it is understood that, although the spatial pattern of signal will be recognizable, the recovery of the PGR signal amplitude from independent models is subject to large errors (models are generally within a factor of 2 uncertainty) and consequently it will not be a feasible to validate the signal amplitude. Another signal for which the spatial signature and the seasonal dependence should be clearly apparent in the GRACE data will be the water mass change of the Amazon basin.

---Static field validation:

One possible approach would be to use the best combined model of gravity observations for a region where the gravity signal is well known, e.g., North America or Europe. However caution is required for this approach to validation as well, because there remains some uncertainty regarding how well individual gravity networks are adjusted to one another at scales relevant to GRACE measurements. Other models of the static geoid, e.g. EGM96, have larger errors than the pre-launch estimates for GRACE static field for scales > 150 km.

Possible group activity/collaboration:

The spring AGU meeting would be an appropriate venue.

Unique data needs:

---All models used to correct the GRACE data should be made available to the team in order to evaluate the corrections as well as the final data product.

Level 3 products:

The GRACE website should include links to site(s) where tools to use the GRACE data can be obtained, and related information products useful for investigation/validation. The website where the tools and information are available should also contain explanations of how to use the tools.

Some examples of such tools and information include:

1- Polygonal descriptions of certain standard basins, that can be used to extract the averaged GRACE signal from the basin.

2- The basin averaging software itself.

3- Averaged surface mass variations for these standard basins, preferably including examples derived using more than one of the various averaging tools that have been developed. Part of this product will be generated in the context of the REASONS-CANS proposal of which Victor is PI.

4- The ocean mass fingerprint signatures of uniform melting on various ice caps (Jim Davis).

5- Links to datasets that can be used to interpret the GRACE signals. Signals from the various data sets should be available in the form of spherical harmonics, and/or software should be provided to perform the spherical harmonic transformation. Examples of signals might include:

I. PGR models

II. Hydrology signals for various model outputs, plus available observational datasets of hydrologic variables.

III. Oceanographic signals for various ocean model outputs, plus available observational datasets of ocean variables.

IV. Surface gravity measurements including the data from the GGP network should be available for the period of GRACE measurements. Also, the GGP should provide product for other investigators, with the appropriate corrections applied and a full description of the corrections, and documentation such as the other user can utilize the product.

Report provided by I. Velicogna

Geodesy Splinter Group Summary

Goal and Unifying Thrust

To enable clear and unambiguous understanding of the GRACE Mission data and products and to assess the quality of the gravity field determination.

Possible Group Activity/Collaboration

- Release by January 2004 of Level 1A data over the same three days for which Level 1B data have been released. This would allow different groups and investigators to check, understand, and verify the algorithms used to produce Level 1B data from Level 1A.
- Release at the same timeframe the relevant documentation.
- Set up teleconferences between interested groups involved in these activities (UT/CSR, JPL, GFZ, GRGS, GSFC, others) to address any issues that may come up.
- Splinter meeting during the spring 2004 AGU meeting.

Additions to Level 2 Product

- Error covariance matrix associated with the mean gravity solution.
- Error covariance matrices associated with the monthly solutions.
- Decide on the definition of the mean gravity solution and its updates (e.g., first release using 1 year of data, to be updated annually?)

Unique Data Needs

- A separate version of Level 1B accelerometer data that filters out “twangs” and maneuvers, so that these data can be used also for DTM work.

Candidates for Level 3 Products

- “Stack” file of GRACE data would be helpful for certain regional and local studies. How difficult would it be to update such a file when certain models are updated (e.g., tides) is an issue that requires consideration.
- Normal equations from surface gravimetry and satellite altimetry, to be combined with GRACE-derived normal equations.

Tests to Discriminate Quality of Models

- Internal consistency tests are already being done (e.g., subset solutions).
- External, independent tests that can assess the accuracy of GRACE products are hard to devise, given the extremely high accuracy of the GRACE information. Additional innovative work is needed here.
- There are few independent data sets that have enough geographic coverage and high enough accuracy (e.g., products obtained from satellite altimetry information), so that they can be used to test certain GRACE products.
- In some cases the existing tests reveal the limitations of the independent data, rather than the errors of the GRACE products.
- Ocean Circulation Model runs that assimilate GRACE-derived geoid information could provide useful information.

Report provided by N. Pavlis

Hydrology/Atmosphere/Earth Rotation Splinter Group Summary

This is the report of the Hydrology/Atmosphere/Earth Rotation breakout group meeting held at the first GRACE Science Team Meeting. Present at the meeting were Jianli Chen, Francis Condi, Jean Dickey, Jay Famiglietti, Matt Rodell, David Salstein, Ki-Weon Seo, Sean Swenson, Paul Thompson, John Wahr and Clark Wilson.

- (1) Scientific Goals. We discussed the scientific objectives that GRACE can address in these areas, and the requirements that GRACE must meet to be a useful scientific tool.
 - (a) Hydrology: GRACE data will allow people, for the first time, to monitor the total continental water budget on a regional-to-global scale. There are numerous applications. The baseline GRACE goal of providing monthly water mass changes to accuracies of 1 cm when averaged over regions of 250,000 km² and greater, is an excellent target. Useful and unprecedented hydrological information could be provided even for degraded accuracy levels. Accuracies as large as several cm averaged over millions of km², could still provide valuable constraints on the water budget in major river basins such as the Amazon, the Congo, etc.
 - (b) The atmosphere: It will be difficult to use GRACE data to extract a useful atmospheric signal. The atmospheric and hydrology signals cannot be separated; and the atmospheric signal is, in general, far better constrained through other types of data and models than is the hydrology signal. There may be cases where the situation is more favorable, such as with the seasonal cycle over central Antarctica where the atmospheric pressure is poorly known and the seasonal snow/ice signal is likely to be relatively small. In addition, the GRACE recovery of hydrology signals should provide indirect information about atmospheric mass and energy balance, because of what those signals imply about precipitation and evapotranspiration.
 - (c) Earth rotation: GRACE C21 and S21 values with accuracy levels consistent with the GRACE baseline estimates, will significantly improve estimates of polar motion excitation caused by mass redistribution. In addition, GRACE data will presumably lead to improvements in hydrological and oceanographic mass balance models; and those improved models should result in a better understanding of all components of rotational excitation.
- (2) Possible contributions to assessing and improving the Level 2 product.
 - (a) Group members will compare the surface mass variability inferred from GRACE, with the output from global hydrology models, to determine whether the GRACE mass anomalies over land appear to be reasonable in terms of their locations, amplitudes, and time-signatures.
 - (b) A tentative plan was developed to address the issue of whether short period hydrology signals might be aliasing into monthly GRACE values. Famiglietti and Rodell will provide output from a hydrology model that includes high-resolution (possibly 3-hourly) temporal sampling. This output will be used to estimate geoid variability at short time scales, which will then be used in simulations at CSR (effort led by Paul Thompson) to determine the likely magnitude of these aliasing effects.
 - (c) We discussed some issues related to the atmospheric corrections in the de-aliasing product. Two issues were of particular concern. One is related to possible complications associated with atmospheric tides - particularly the semi-diurnal tide. The atmospheric pressure contributions are removed by linearly interpolating between 6-hourly fields. The question is whether this permits an adequate representation of the semi-diurnal tide; and whether the difference might be large enough to have a significant

aliasing effect. The other issue involves what to do about offsets in the ECMWF output caused by changes in the ECMWF modeling algorithms. Nothing is done about those offsets at present. The first-order question is whether those offsets could cause significant signals in the GRACE monthly solutions. If so, then some procedure should be designed to minimize their impact. At the very least, it would be helpful if the level 2 products include a flag that indicates the times of significant model changes.

We did not resolve how best to address either of these issues. But it's clear that both of them will require interaction between the people constructing the GRACE gravity solutions and the atmospheric scientists on the GRACE science team.

- (3) Candidates for Level 3 products. Hydrological studies are apt to require GRACE estimates of changes in water mass storage over specific regions. This requirement can be met either by supplying those estimates directly, or by providing software that would enable users to process the GRACE data themselves to generate their own mass anomalies for whatever region they wish. Both these options are being considered for inclusion in the GRACE-related REASoN-CAN effort, lead by Victor Zlotnicki.
- (4) Group meeting. Jay Famiglietti is considering organizing a meeting in Irvine in March, 2004, for people interested in GRACE and hydrology. The meeting might be held in conjunction with a meeting of NASA's Surface Water Working Group.
- (5) Possible group activity/collaboration. It seems clear that at this point in the development of the GRACE Project, the issue of how to minimize the effects of temporal aliasing (including the effects of ocean tides) on the GRACE gravity solutions is of fundamental importance. This is an issue that tends to connect different breakout groups with one another and with the people who are generating the GRACE gravity solutions. One point that came up within the context of group discussions is that it may be desirable to formalize some sort of de-aliasing discussion that cuts across disciplines. It's not obvious how best to do this. But it is clear that the effectiveness of any such activity would depend on whether the GRACE Project is able to commit sufficient resources to generate multiple gravity field solutions to look at the impact of different de-aliasing products.

Report provided by J. Wahr

De-aliasing Splinter Group Summary

Overall theme: the GRACE time-varying 'monthly' solutions, which at the time numbered 3, had N-S 'stripiness', most visible over the oceans where the signals are weaker. This can be caused by aliasing, among other things. Since we are aiming for monthly solutions accurate to 1 mmH₂O, but probably have dealiasing models (tides, atmosphere, ocean) accurate to between 10mm and 20mmH₂O, it is crucial to bring those down as much as possible.

Atmosphere:

- We did not know of anything suspicious in the current ECMWF-based dealiasing.
- I don't think we discussed, but should have, the differences ECMWF-NCEP as a measure of current error in ECMWF. Somebody should run this for 2002-2003.
- We discussed replacing the 4/day model samples, which fail to properly sample the atmospheric S₂, with the model for S₁ and S₂ from the 2003 work by Ponte & Ray (GRL), Ray & Ponte (Annales Geoph.). We did not quantify the size of this error. The P&R, R&P propagating S₂ solution filters out many short scales over land, where atmospheric signals matter most. It is possible to restore some of those signals (fig. 7 and ECMWF(2) solution in table 1 of Ray & Ponte) and that might work better over land. Table 1 can also give a crude sense of what the S₂ errors are.

Ocean (non-tide):

- VZ was unable to quantify the accuracy of the barotropic ocean dealiasing (PPHA) at the time of the meeting. Since then, VZ and Ahmed Ali have determined that the PPHA barotropic model used to dealias correlates well with the ECCO/JPL baroclinic model, but has less energy (globally-averaged RMS of 1.2 cm vs 1.5 cm for ECCO differences from monthly averages). However, independent test performed by Richard Gross at JPL show that the PPHA model SIMULATION has a 61% correlation with the non-seasonal variance in ocean excitation of polar motion, vs 56% for the ECCO SIMULATION and 72% for the latest ECCO version with data ASSIMILATION.
- VZ will provide at least one other model, ECCO baroclinic, sampled at least 4/day (the data have already been prepared by the JPL ECCO group). These are ready for the Project to test in gravity model estimation.
- We agreed that, at some point in time, it will be necessary to reprocess a few months of GRACE with a 'maximally different but reasonable ocean model', just as it will be necessary to do a test with a 'maximally-different but reasonable' tide model. This would be ECCO with assimilation.

IN a separate email I will tell you everything I have found out since then about PPHA, its differences with ECCO, and their match to TOPEX and rotation data. There is more than is summarized above.

Hydrology:

We did not discuss this topic at length. Shorter period hydrology exists but at this time we do not know of any global model accurate enough to remove it. We did agree that a 'dealiasing working group' needs to be formed that includes expertise in hydrology to see the extent to which short period hydrology signals can be modelled out.

Ocean (tides): these are the most energetic source of aliasing. A separate report sent by Richard Ray is included below.

Report provided by V. Zlotnicki

Ocean Tides

To understand the degree that tide modeling errors are inducing errors in gravity solutions, it is recommended as a quick initial step to perform some gravity inversions at CSR which replace the CSR4 ocean tide model with another (relatively) independent model. All good ocean tide models are presently based on Topex/Poseidon data, and we must accept this lack of complete independence if we wish to employ an acceptably accurate model. There are, however, differences in tide models caused by differences in analysis methods, differences in additional data, and differences in the degree to which T/P data are fit. Wahr, Ray, and Tapley all suggested using the LEGOS FES2002 model, for two reasons: (a) FES2002 is the model adopted by GFZ, so comparing solutions in this way would help give a handle on some of the CSR - GFZ gravity differences. (b) FES2002 is a good global model but is probably maximally different from the other "good" models that we are aware of, since it fits T/P data less tightly in the open ocean and has large differences (potential improvements) in the polar seas.

Ray (GSFC) already has the FES2002 model in either gridded form or in spherical harmonic coefficients, and he will send these datasets to CSR (and JPL).

It is our understanding that CSR software still requires minor spectral lines, including all nodal lines, to be given explicitly. If this is the case, then unless special automated software exists it will be a chore to generate all required coefficients for FES2002. Ray suggests that the minor lines of FES2002 probably are not significantly different from the minor lines of CSR, and he therefore suggests converting only the main tidal lines of FES2002 (which are the 8 major short-period constituents plus 2N2). In addition, the (2,2) and possibly (4,2) coefficients of the S2 tide must be modified to allow for the air tide, as is already now being done with the CSR4 model.

Report provided by R. Ray

Research Summaries

Alsdorf, Doug, Dunne, Tom, and Melack, John
UCLA and UCSB

Hydrologic Modeling of the Central Amazon Basin Using Remotely Sensed Data

Continental-scale models of water mass-balance and transport provide the link between global climate model (GCM) simulations (e.g., precipitation and evaporation) and local observations of basin discharge. Although precipitation and in-channel gauge data combined with remotely sensed imagery of inundation area provide some constraints on basin wide hydrologic models, overall verification of the models is significantly hindered by the paucity of in-situ observations and scaling parameters that are not easily related to hydrologic processes. A key unknown in these models is floodplain storage. For example, 25% of the Amazon River annual discharge is calculated to exchange with the floodplain, yet this value is unverified because no gauges exist on the floodplain itself and the topography of this huge and complex floodplain is essentially unknown. Furthermore, unlike the main channel of the Amazon River itself, diffuse, unchanneled flow across the floodplain requires more than a single sampling location to measure its discharge. Given the vast size and remote location of the Amazon Basin, it is unlikely that there will be a significant densification of ground level observations. Instead, we have found that interferometric processing of synthetic aperture radar (SAR) data can yield estimates of floodplain storage. Therefore, we plan to develop a water mass-balance and transport model for the central Amazon basin that will be entirely based on satellite-borne observations. The modeling effort will pay particular attention to the tremendous water storage changes in the floodplain wetlands of the large alluvial basins in the central Amazon, which up to this point have not been the focus of land-phase and channel-phase hydrologic studies (others have largely concentrated on basin-wide patterns of evapotranspiration and soil moisture storage).

Five satellite systems will be central to our model: (1) tropical rainfall measuring mission (TRMM) estimates of monthly average precipitation, (2) radar altimetry observations of water height variations in main river channels, (3) SRTM digital elevation model (DEM) data, (4) interferometric processing of archived JERS-1 SAR to derive floodplain storage, and (5) Gravity Recovery and Climate Experiment (GRACE) observations of changes in the total water column (Q_{tot}). Data from Topex/POSEIDON radar altimetry and TRMM are already archived and available for the central Amazon basin, thus project data processing will focus on interferometric analysis of JERS-1 data and newly acquired GRACE observations. To verify and anchor the extensive interpolations made from the interferometry, we will collect new floodplain measurements of water height changes and combine these with our large archive of in-situ observations from river and precipitation gauges.

Our model will be used to test several hypotheses related to floodplain hydrology: (1) Q_{tot} from our hydrologic model equals GRACE measures of Q_{tot} , (2) recession floodplain storage change is less than previous model based estimates, (3) diffusion modeling can be used to represent floodplain storage changes, and (4) flooding extents from large rainfall events are correlated with interferometrically measured floodplain storage changes and topography.

Chambers, Don
Center for Space Research

Application of GRACE Data to Improving Ocean Heat Storage Estimates from Satellite Altimetry

The goal of this investigation in the first year is to quantify the accuracy of GRACE time-variable gravity maps in reconciling the difference in steric sea level measured by XBTs and total sea level measured by altimetry. I have selected regions with large barotropic variability that should be observed by GRACE and sufficient coverage by XBTs. In the first year, we will compute a month climatology of residuals (total sea level - steric) in these regions, and compare this to the "monthly" variations observed by GRACE to quantify the correlation and portion of the variance that GRACE observations can explain. It will be particularly important to correct the GRACE maps for the "monthly" ocean barotropic signal included in the de-aliasing procedure (or else remove the same signal from the altimetry and steric residuals). The overall objective is to show that using GRACE data will lead to improved estimates of heat storage computed from altimetry.

Chao, Benjamin
Goddard Space Flight Center

Geophysical Validation for GRACE Time-Variable Gravity: Two Case Studies

Objectives:

(1) The Mediterranean + Black Seas. Oceanographic, meteorological, and hydrological data, both in situ and from space, that are publicly available will be assembled, and the ocean general circulation models specifically for the Mediterranean + Black Seas will be surveyed and their data output acquired. These information will then be integrated to determine the water mass transport for the Mediterranean + Black Seas. The resultant time-variable gravity signal will be computed for GRACE data cal/val.

(2) The Three-Gorges Reservoir in China. The water impoundment of the Three-Gorges Reservoir has begun in June 2003, and will continue in 3 phases till 2009. About two-thirds of the 40 km³ capacity water will be impounded during the GRACE lifetime. The water impoundment, its surface loading effect, and the time-variable gravity signal of this "controlled experiment" will be computed for GRACE data cal/val.

**Chen, Jianli and Wilson, Clark R,
Center for Space Research, The University of Texas at Austin**

GRACE Validation: Discrete Harmonics and Covariance Properties of Time-Variable Gravity Using Earth Rotation and Climate Models

Independent knowledge of temporal variations in the earth's gravitational potential will be important for validating GRACE results, for bounding temporal and spatial alias error levels, and possibly for reducing the effects of alias errors in the final GRACE products. We propose to study low degree temporal gravity variations, including C_{20} , C_{21} , and S_{21} and other harmonics using Earth rotational observations in combination with other data, especially numerical climate and ocean model time series. Sub-milliarcsecond precision is now routinely achieved in daily or sub-daily Earth orientation measurements, corresponding to millimeter precision of mass loading changes if due to a water load at the surface. When combined with climate model data to remove the effects of angular momentum exchange (winds and currents) earth rotation observations can provide remarkably precise measures of gravity variations at specific spherical harmonics. Earth rotation information is complementary to climate model results alone as a way to validate GRACE products and understand alias error variances.

The main efforts of the proposed study are to estimate time series of C_{20} , C_{21} , and S_{21} and other low spherical harmonic degree variations using length-of-day (LOD) and polar motion data, satellite laser ranging data, and climate models; compare these estimates with GRACE products; and estimate alias and other errors in low spherical harmonic degree and order GRACE products. The data and models to be analyzed include IERS LOD and polar motion time series, LAGEOS SLR analyses, relevant data fields from (but not limited to) the NCEP reanalysis, the ECMWF operational model, the fully coupled NCAR climate system model (CSM), and the ECCO data assimilating ocean general circulation model (OGCM). In addition, we will use the climate models to study and develop models for the variance and coherence spectra of time variable gravity across temporal frequency and time, and spherical harmonic degree and order.

We expect the following major deliverables:

1. Methods for independent estimation of low degree and order temporal gravity variations by combining Earth rotation, laser ranging, and climate model information.
2. Independent determination of low degree (C_{20} , C_{21} , and S_{21} and other) time series to validate GRACE results and assess alias and total error variance.
3. Estimates of correlation or coherence of gravity fluctuations across spherical harmonic degree and order from climate models, to be used in evaluating and validating GRACE products, and possibly in future reprocessing.
4. Models of the Stokes coefficient variance spectrum (as a function of time or temporal frequency, analogous to a "Kaula's Rule" for time variable gravity) from climate sources to evaluate GRACE products in terms of alias and total error variance, and for possible use as constraints in processing GRACE observations.

Dickey, Jean O., Boggs, Dale H., Marcus, Steven L.
Jet Propulsion Laboratory

Collaborators

Y. Chao (JPL), V. Dehant (Royal Observatory, Brussels - RBO), Olivier de Viron (RBO), R.J. Eanes (CSR, UTx), M. Ghil (UCLA), R.S. Gross (JPL), R. Hide (Imperial College, London), Andrew Jackson (Leeds University), J.M. Wahr (Colorado), V. Zlotnicki (JPL)

Variations in Earth Rotation and Time Variable Gravity: Insights via Space Geodesy

The Earth is a dynamic system—it has a fluid, mobile atmosphere & oceans, a continually changing global distribution of ice, snow, & ground water, a fluid core that is undergoing some type of hydro magnetic motion, a mantle both thermally convecting & rebounding from the glacial loading of the last ice age, & mobile tectonic plates. These processes affect a number of global geodynamic properties of the Earth including its gravitational field, rotation, & the geocenter. Since the gravitational field of the Earth changes only in response to net mass redistributions, observations of the Earth's time varying global gravitational field allow the isolation & subsequent investigation into the changing mass distribution of the Earth. We propose to investigate the effect of these, & other global dynamic Earth processes on the Earth's gravitational field using models of these processes in concert with time-varying gravitational field measurements. The expected launch of GRACE in March 2002 will mark a new chapter in gravity field studies; we plan to utilize fully the resultant data. In addition, we will investigate Earth rotation variations with the goal of observing and understanding the interactions of the atmosphere, core, ocean, and other subsystems with the rotational dynamics of the Earth, and their contributions to the excitation of Earth rotation variations. Highly accurate observations of Earth orientation provide a unique and truly global measure of natural and man-made changes in the atmosphere, oceans, and interior of the Earth.

Famiglietti, James
University of California Irvine

Terrestrial Water Storage Variations Using GRACE: Estimation, Uncertainty, and Validation

Overall Objectives: The three overall objectives of this project are to: 1) produce monthly, seasonal, and annual GRACE-derived estimates of terrestrial water storage variations for selected watersheds and other hydrologically-significant regions around the globe; 2) characterize the corresponding estimation uncertainty, including recognition of irregular boundaries and of temporal aliasing; 3) validate GRACE-derived water storage variation estimates by several methods, including observation-driven water balances, output from data-assimilating global models, and direct observation of water storage and aquifer level variations where available. Implicit goals are also to build towards a framework for routine, global production and validation of monthly-to-annual water storage change estimates and their uncertainties; and to provide modeled and observed data on high frequency terrestrial hydrological variations that can be used to assess the impact of temporal aliasing on estimation uncertainty and to guide future mission design.

First Year Objectives: Important goals for year 1 are to identify locations where significant hydrologic variations are apparent from first GRACE products and to produce mass change estimates there with comparison to observations and model outputs. More generally we will begin by identifying basins/regions (e.g. aquifers) where we will produce time series of water storage change estimates, develop the shape filter functions, perform spatial variance leakage and contamination studies; and begin temporal aliasing studies. We will also begin to assemble validation data for the selected basins.

Gross, Richard
Jet Propulsion Laboratory

GRACE, Mass Displacements, and the Earth's Rotation

Overall Objective: To investigate the gravitational and rotational response of the Earth to mass displacements caused by: (1) atmospheric, oceanic, and hydrologic effects; and (2) earthquakes. To validate GRACE measurements of the time varying second-degree gravitational field coefficients against independent Earth rotation measurements. To investigate the mechanism(s) exciting the Chandler wobble by using GRACE measurements and numerical models of time varying atmospheric, oceanic, and hydrologic pressure fields. To better constrain the frequency dependence of mantle anelasticity by using improved knowledge of the excitation mechanism(s) of the Chandler wobble to better determine its period and decay time constant.

First-Year Plan:

1. Validate time-varying 2nd-degree gravitational field coefficients from GRACE using independent Earth rotation measurements.
2. In collaboration with Geoff Blewitt and colleagues, validate time-varying low-degree (2-6) gravitational field coefficients from GRACE using independent measurements of the mass load acting on the surface of the Earth inferred from GPS measurements.
3. Study the excitation of the Chandler wobble using measurements of the changing load on the surface of the Earth inferred from GRACE measurements in concert with atmospheric, oceanic, and hydrological models.
4. Compute the coseismic effect of earthquakes on the Earth's gravitational field to high degree and order and search for the predicted signature of the largest earthquakes in the time-varying GRACE gravitational fields.

Hughes, Chris
Proudman Oceanographic Laboratories

My work, together with Prof. Keith Haines of Reading University and Prof. Philip Moore of Newcastle University, is concentrated on the problem of aliasing of high frequency mass fluctuations in the monthly GRACE gravity solutions. Our aim is to combine ocean and other models, with orbit calculations, to find the optimal way to mitigate aliasing problems. Work so far has concentrated on a global barotropic ocean model, with interesting results concerning rapid fluctuations of J2 and the surprisingly important role of the Arctic Ocean, even for global scale spherical harmonics.

Ivins, Erik
Jet Propulsion Laboratory

Geodetic Signatures of Cryospheric Change and Interaction with the Lithosphere, Mantle and Ocean

The work involves a comprehensive assessment of mass balance in polar ice sheets, changes in continental hydrology and in the world's glacial complexes via the tools of geodesy, focusing on time-variable gravity, crustal motion and isostatic flow in the deep Earth. The theoretical and observational methods for monitoring oceans, ice sheets, land hydrology and atmospheric change since the 1980's have a strongly multi-disciplinary flavor. We shall model inelastic solid earth deformation, while at the same time account for the gross geodetic signatures of continental-ocean mass exchange. Our objective is to constrain ice sheet and hydrological change and their influence on sea-level change. Specific tasks of the proposed work for the first year focus on:

- To directly search for optimized solutions for hydrological mass transport using combined GRACE, IceSat and GPS data sets with input from other terrestrial and space-based constraints, while accounting for mantle viscosity and lithospheric structure parameters. We shall incorporate recent glacial mass balance estimates for Antarctica, Greenland, Patagonia and smaller ice complexes as a priori information for assessing GRACE gravity.
- To provide map-view predictions of Coulomb stresses within the seismogenic crust using our new software that computes the full 3-D stress tensor components in the top elastic layer of a layered viscoelastic postglacial rebound simulation code. These map-views may be compared to seismicity patterns observed in Antarctica, Greenland, Scandinavia, British Isles and regions of North America, such as the St. Lawrence Valley.

Second and third year activities will strive for the following:

- To produce 30-year time-average secular rate of change estimates for the Stokes coefficients of the gravity field associated with the individual mass change contributions. The sources/sinks of sea-level change shall include: (i) Antarctica, with subdivision into major drainage basins, (ii) Greenland, separated into 4 sub-regions, (iii) each of the continents, Africa, North and South America, Eurasia, Australia and Southeast Asia and archipelagos, (iv) postglacial rebound with an uncertainty budget, (v) sea-level change, with eustatic and non-eustatic self-gravitational components separated. This task shall facilitate an integrative bridge between the LAGEOS-class gravity change data, with its 26-year long data record, and the upcoming GRACE 5-year, high-resolution, data sets. Such a synthesis shall greatly complement GRACE gravity field interpretation.
- To provide software for assessment of the gravitational self-attraction between ice and ocean masses, as these are important for the interpretation of geoid and sea-level changes monitored by the Topex-Poseidon and Jason altimetry missions.
- To provide a map-view set of predictions of the gravity change, gravity change gradient and 3-D crustal motions that are anticipated from high resolution studies of glacier change and mantle-lithospheric rebound in Patagonia. Our study provides a unique target for the GRACE gravity mission and, possibly, for gravity gradiometer missions such as GOCE. It is also anticipated that the crustal motion predictions shall be useful for regional GPS data interpretation, such as that being conducted by Prof. Mike Bevis of the Ohio State University.

Jekeli, Christopher
Ohio State University

Validation of GRACE Level 2 Data Products and Development of High-Resolution Regional Gravity Field Models

The primary GRACE Level-2 science data product, sets of spherical harmonic geopotential coefficients (spatial resolution: degree and order 120, temporal resolution one month), are derived from standard orbit perturbation analysis algorithms using GPS hi-low tracking and low-low inter-satellite ranging measurements. We propose to use an alternative data processing technique (Jekeli, 1999 and Han, 2003) to compute the disturbing potential and gravity disturbance differences at GRACE altitude assuming energy conservation and kinematic acceleration models, as well as precise orbit determination. Using these techniques, we will generate local (as well as global), in situ data products that can be used for validation purposes as well as for high-resolution, regional gravity modeling. Validation with this approach can be accomplished by using direct, forward modeling (upward continuation) of terrestrial gravity and fluid mass distribution data. We will validate the GRACE gravitational measurements (potential and LOS acceleration) by a direct comparison between the on-orbit derived quantities and corresponding model values predicted at altitude through forward modeling. The mean (or static) signals can be predicted from existing, extensive gravity data bases, e.g. in the U.S. and the Arctic region. The time-varying signal, based on monthly averages, can be estimated from global tidal, atmospheric, oceanic, continental hydrologic, and ice mass models. In all cases, a forward modeling approach can and will be used, being the simplest and most direct method. This approach also enables a direct improvement of the time-varying mass models by estimating their parameters through a constrained (weighted), linear, least-squares adjustments of the in situ data products. Regional gravity modeling will be demonstrated by using downward continuation methods applied to the local, in situ data. With these techniques one is better able to exploit the high density of GRACE measurements generated in the polar region. We propose to test our resulting models in the Arctic and thus provide a predicted accuracy for the model in the Antarctic.

During the first year investigation, we will generate in situ gravitational measurements (potential difference and LOS acceleration) based on Level-1B data and possibly Level-2 precise orbits. We will validate these products internally using GRACE Level-2 geopotential models, and externally using terrestrial data and time-variable geophysical mass models for some specific regions. The objectives of this investigation for three years of periods are 1) to use an alternative data processing to provide in situ gravitational measurements; 2) to validate GRACE science products based on them; 3) to develop the high-resolution regional gravity models using in situ products. The detail schedule would be the followings:

- Year 1: Develop complete in situ measurement models (gravitational potential difference and LOS acceleration) on the basis of available Level-1B GRACE data products and conduct preliminary validation tests of GRACE data. Continue with development of accurate downward continuation algorithms. The result will be a demonstration and test of alternative Level 2 data products. These will be used for internal validation of the standard GRACE Level 2 data products, for external validation using terrestrial gravity and time-varying global mass models, and for regional static gravity modeling.

- Year 2: Develop comprehensive time-varying validation models for in situ measurement comparison and begin static validation using extensive U.S. and other gravity data

bases. Develop and test regional gravity modeling based on downward continuation methods with specific application to the Arctic region. Results will include alternative validation of GRACE data products and procedures for regional modeling.

- Year 3: Conduct extensive static and time-varying validation of GRACE data products. Create high-resolution regional gravity models in polar regions, using available data, specifically in the Arctic, to test and validate the regional models.

Knudsen, Per
National Survey & Cadastre (KMS)

For the future Science Team we would like to continue our studies of ocean tides and sea level variations using GRACE temporal gravity fields. Furthermore, we wish to combine GRACE temporal gravity with altimetry to study the ocean variability further and the associated changes in mass and their loading effects. Naturally, we will continue the work on estimating dynamic ocean topography and ocean circulation.

Larson, Kristine
University of Colorado Boulder

Short and Long-Term Stability of the GRACE Ultra Stable Oscillator

One of the critical components of the GRACE experiment is timing as defined by ultra stable oscillators (USO) designed by APL. Timing accuracy of the USO's can be determined by comparing the data collected by the GPS receivers operating in each spacecraft. The primary goal of this proposal is to assess the error spectrum of the USO and GPS time-transfer system. We propose to compare the GRACE USO's to hydrogen masers on the ground, evaluating and mitigating the impact of any systematic errors. Another method of evaluation is to compare USO estimates with the K-band ranging data [Bertiger et al., 2003].

McAdoo, David C. and Childers, Vicki A.
NOAA and NRL

Other Co-Is; Seymour W. Laxon, UCL; Carl Wagner NOAA, John M. Brozena, NRL, Steve Kenyon, NIMA; Rene Forsberg, KMS; Remko Scharroo, NOAA.

**High Accuracy Gravimetric Geoid for Arctic Research (HAGGAR)
From GRACE, Airborne, and Surface Data**

The cryospheric, oceanographic, as well as the geodetic and solid-earth sciences require a gravimetric geoid for the Arctic Ocean which is everywhere accurate to the level of a few centimeters at all wavelengths. By optimally combining data from the GRACE mission with current airborne and surface gravity data we seek to meet this requirement within the next three years. Development and verification of the high-accuracy, static geoid model for the entire Arctic is this project's primary objective, and will enable altimeter satellites to accurately monitor and comprehensively map thickness plus mass flux of Arctic sea ice. Moreover, this geoid will allow the application of satellite altimetry to mapping of the Arctic Ocean circulation and surface geostrophic currents. Most importantly, this geoid will provide a reference frame against which absolute measurements of time-varying oceanographic features, such as dynamic topography and sea ice cover, can be repeatedly calculated through comparison with altimetric height measurements.

TO DATE: Spectral domain evaluations and error analyses of GRACE static geopotential models (GGM01S and EIGEN-GRACE) have been employed to begin designing an optimal high-cut filtering strategy for GRACE data in the Arctic. The detailed international Arctic Gravity Project ARC-GP field (based largely on aero- and surface gravity) has been used as a benchmark for evaluating the accuracy and resolution of GRACE models at intermediate wavelengths (300 to 1500km). GRACE models confidently resolve and improve our understanding of Arctic gravity to wavelengths as short as 500km and the precision of GGM01S and EIGEN-GRACE models appear nearly identical. GRACE satellite-only geoids are precise (all wavelengths) to 40 cm, or better, over much of the Arctic.

FIRST YEAR: We will finalize our optimal high-cut filtering strategy for GRACE data in the Arctic. Preliminary Arctic geoids and gravity (hybrid) fields will be constructed by combining the GRACE data at long (> 500-700? km) wavelengths, with the detailed ArcGP gravity results. These hybrid geoids will be compared with/subtracted from ERS altimetric mean sea surfaces in an attempt to detect poorly known dynamic topography of the Arctic Ocean.

THREE-YEAR PLAN: We will use a Wiener filtering approach to optimally combine the GRACE data, highly accurate at long wavelengths, with the complementary aero-gravity and surface gravity data sets to produce the final geoid and gravity product. This will include reprocessing of all surface and aero-gravity and can only be done if resources permit. Final geoid assessment will include computation of experimental maps of dynamic topography and sea ice thickness.

Pavlis, Nikolaos
Raytheon ITSS Corporation

Analysis of Surface Gravity and Satellite Altimetry Data for Validation of and Combination with GRACE Information

We propose to conduct a comprehensive analysis of up to date detailed surface gravity information, and of satellite altimetry data, so that these data sources can be used for:

- 1) The calibration and validation of the gravitational information anticipated from GRACE.
- 2) The eventual combination of the same information with the GRACE data, for the development of comprehensive solutions for the geopotential.

Detailed surface gravity data that are held within NIMA will be used, along with very high resolution mapping of the Earth's surface from space (SRTM, and possibly ICESat), to form for the first time a worldwide database of area mean gravity disturbance values. These values will be made available to the GRACE project (and eventually the wider science community) at 1' and 30' resolutions (which allow extension of the geopotential expansion well beyond the sensitivity of GRACE).

The 1' gravity disturbances will be used to develop normal equations for gravitational coefficients to degree and order 160, and for coefficients representing systematic errors in these data to degree and order at least 90. Special emphasis will be placed on the careful consideration of the error properties of these data.

Normal equations will also be developed using altimeter data in two forms: as direct "vertical" tracking data, and as Sea Surface Heights obtained from an ocean wide Mean Sea Surface model. In both cases the gravitational coefficients will extend to degree and order 160, and the Dynamic Ocean Topography coefficients to degree and order 120.

The surface gravity and satellite altimetry normal equations will be used in preliminary combination solutions with GRACE information, that will focus on aspects of optimal weighting of the respective data, and on the careful examination of the recovered fields, particularly the systematic errors in surface gravity and their likely origin(s).

After validation, we will make the surface gravity and satellite altimetry normal equations available to the GRACE science team. These normal equations provide information that is highly complementary to the gravitational information from the GRACE data. We propose to coordinate our activities with those of other GRACE team members, so that our contribution can be of maximum value to other investigators within the GRACE team who are involved in global geopotential modeling studies. We are also willing to partner with any team members interested in the development of geopotential solutions that combine GRACE data with surface gravity and satellite altimetry data

Pavlis, Erricos
University of Maryland - Baltimore Cnty

Current and Future Satellite Mission Data Analysis for Global Gravity Field Modeling and Reference Frame Implementation

Our goal is to contribute towards the WGS maintenance and enhancement efforts, with the development of a state-of-the-art global static gravity model for general use, in collaboration with NIMA and their partners. The following tasks are part of this effort:

- 1) Develop a satellite-only gravity model based primarily on data from the new missions, first CHAMP, and later, GRACE, (and in the future GOCE). Improve the long wavelength components of the model with the addition of information from other satellites tracked by GPS and SLR.
- 2) Subsequently, incorporating NIMA's surface gravity data, satellite altimetry information, and considering also temporal variations derived with 4-D space geodetic techniques from the GRACE project, develop a high degree and order combined model.
- 3) Develop efficient techniques and methodologies (s/w) to combine ground satellite tracking data, altimetry, surface gravimetry and the new data types from CHAMP, GRACE, and later GOCE.
- 4) Develop the procedures and software for the validation, evaluation and reduction of new data types which will be acquired from the new missions CHAMP, GRACE, GOCE.
- 5) Develop new procedures and standard data sets to test the accuracy of the new models.

Ray, Richard
Goddard Space Flight Center

Tides For and From Grace

Our work addresses tidal problems related to the GRACE satellite gravimetry mission. As the title makes clear, we intend (1) to provide to the GRACE project (and others) an improved set of comprehensive tidal models for use in processing the satellite-to-satellite ranging data and (2) to investigate the ability of the GRACE data themselves for improving our knowledge of tides. The tidal models to be developed include both atmospheric and oceanic tidal models. We anticipate that tidal solutions from GRACE data will be more successful for lunar tides than for solar tides, since the latter are aliased to unfavorable periods contaminated by other signals. We shall be especially interested in lunar tide solutions over the polar seas where other data are generally lacking.

Salstein, David
Atmospheric and Environmental Research Inc

Atmospheric Mass and Motion Signals in GRACE and Earth Rotation Measurements

In the first year we will concentrate on the quality of the atmospheric surface pressure data that are available from various atmospheric analyses, including reanalyses, as well as make initial comparisons with atmospheric surface data. We will develop plans to derive the various harmonics of the atmospheric data, and we plan to derive GRACE gravity fields for a test period and begin making comparisons between the atmospheric harmonics and the gravity field.

The overall three-year objectives are:

- 1) We will make calculations of atmospheric surface pressure harmonics from atmospheric reanalysis systems. In doing so we will compare those of the NCEP-NCAR system with those that will be available such as the NASA GEOS-1 Data Assimilation System, and the expected 40-year reanalysis of the European Centre for Medium Range Weather Forecasts.
- 2) We will estimate the quality of atmospheric surface pressure for both its dry and wet mass, including comparisons with stations over land and ocean areas.
- 3) We will compare the atmospheric mass fields with Earth gravity fields derived from GRACE, and support the mission that will determine climate signatures that may be associated with the atmosphere.
- 4) We will test the quality of the overall surface pressure fields as well in calculations involving global atmospheric mass and angular momentum balances.

Shibuya, Kazuo
National Institute of Polar Research (NIPR)

Calibration/Validation of GRACE-derived gravity fields using the ground data obtained in the Japanese Antarctic Research Expedition area and Syowa Station, Antarctica

We are planning to detect the gravitational effects related with the ice sheet thinning (10 – 20 cm/year) of the Shirase Glacier drainage basin, change of ocean dynamics around the Lutzow-Holm Bay region, and postglacial rebound in the Japanese Antarctic Research Expedition (JARE) area from the GRACE-derived time-series of gravity fields. The GRACE Level 1/2 data will be compared and interpreted with the Syowa Station geodetic observations (VLBI, GPS, DORIS, sea level meter, superconducting gravimeter, absolute gravimeter, synthetic aperture radar scenes, surface synoptic observations, etc.) and regional marine and oversnow geophysical/glaciological archived data. New surveys to have precisely calibrated gravity values (10 - 20 μ gal absolute accuracy) are planned on the ice sheet of JARE area, while ocean bottom pressure sensors will be deployed in the surrounding oceans to know actual mass changes of the ocean area.

Shum, C.K.
Ohio State University

Validation of GRACE Data Products: Characterization of Roles of Ice Sheet and Oceanic Mass Variations in Global Sea Level Change

We propose to validate GRACE Level 2 Science Data Products in the form of monthly geopotential solutions complete up to degree 120 over Antarctica and the global ocean. Using an alternate data product in the form of disturbing potential difference and LOS acceleration, we will validate the GRACE Science Data Product by replacing and assessing alternate correction models (atmosphere and tides) for the accurate determination of ice, hydrological and oceanic mass signals. This type of in situ measurements would be linear and additive, thus represents an efficient technique. Specifically, over Antarctica and over portions of the Southern ocean, improved pressure profiles will be tested using the NSF/UCAR Antarctica Mesoscale Prediction System (up to 30m resolution, 3-hourly), as well as pressure profile data from SAC-C, CHAMP and GRACE GPS occultation, and ECMWF. Diverse tide models will be evaluated to support the GRACE Science Data System. Science objectives include the determination of the Earth's ice sheet (Antarctica and Greenland) and oceanic mass variations and characterize their roles in global sea level change. The specific approach is to model glacial isostatic adjustment, use data from GRACE, radar altimetry, thermal expansion measurements of the ocean, in a forward geophysical inverse solution to quantify these significant components of the global sea level signal. The specific goal of the proposed investigation includes supporting the GRACE Project for the validation and potential improvement of the Level 2 Science Data Product, and to definitively determine the mass signals of the ice sheets and oceans at the seasonal and interannual scale using the available 2-3 years of GRACE data. The proposed investigation intends to conduct a comprehensive study on the interdisciplinary problem towards a better understanding of global sea level change.

Specific tasks during the three-years investigation include:

Year 1: Development of in situ gravitational measurement (disturbing potential difference and LOS acceleration) data processing using GRACE Level-1B data products. It will include complete modeling and estimation capabilities of ocean tides, N-Body, solid Earth tides, etc. Development of occultation processing for improved pressure profile retrieval over Antarctica. Support post-launch commissioning validation of GRACE Science data products assessing different atmospheric models (including the Antarctica Mesoscale Predict Program models, NCEP, ECMWF), and ocean tide models. Support the GRACE Project in recommending improved models.

Year 2: Determination of mass variations using in situ measurements (collected by T.U. Dresden), validate and assess the accuracy of GRACE derived temporal gravity field data products. Comparison with altimetric and thermal (and salinity) data for sea level budget studies. Test GIA models and GRACE data in forward geophysical inverse studies.

- Year 3: Conduct solutions of GRACE ice sheet and oceanic mass variations using available GRACE data. Perform geophysical inverse solution and final comparison with other data (altimetry over ocean and ice, thermal data).

Stammer, Detlef
IfM Hamburg

Ocean Current and Mass Signals and Their Impact on Earth's Variable Rotation and Gravity Field

Summary of research (1st year)

- Use time-mean gravity field inferred from GRACE for ocean state estimation, test its intrinsic uncertainties, assess impact of GRACE geoid on ocean circulation and mass field estimates
- Assess needs and priorities regarding de-aliasing issues, apply available model and state estimation products to de-alias GRACE data, develop new de-aliasing procedures as needed
- Characterize variability in GRACE data related to ocean signals, compare with available estimates from ocean models and data, test GRACE products in the context of global angular momentum budget and observed Earth rotation signals

Overall 3-year objective

- Use a number of numerical ocean models and state estimation procedures in combination with available oceanic, atmospheric, and geodetic datasets to examine the variability in the ocean circulation and mass fields and its effects on the GRACE measurements and data analysis, and enhance the ability of GRACE to recover gravity signals of non-oceanic origin
- Use GRACE data and related products to clarify the role of ocean mass signals as source of variability in ocean angular momentum and associated torques mediating ocean-solid Earth interactions, determine the impact of those signals on the variable Earth's rotation (length-of-day and polar motion), and enhance the ability to study other geophysical processes of non-oceanic origin (core-mantle coupling, hydrology, etc.) affecting the Earth's rotation.

Velicogna, Isabella
University of Colorado Boulder

Geopotential Heights for GRACE De-Aliasing: Comparison of SAC-C, CHAMP and GRACE Occultation Data with Global Circulation Models

Year 1: We will evaluate the size and significance of differences between ECMWF and GPS occultation-derived estimates of geopotential heights, particularly in the polar regions and over the southern hemisphere where in situ measurements of atmospheric pressure are scarce. Differences will be integrated to obtain an estimate of error in atmospheric mass estimated from ECMWF output. We will average the atmospheric mass differences during each epoch of GRACE geoid coefficient solution, using the Gaussian spatial averaging functions described in Velicogna et al. [2001]. This will provide an estimate of the localized atmospheric mass error in that GRACE coefficient set.

Abstract: GRACE estimates of the time-variable geoid will be corrected for the gravitational attraction of vertically integrated atmospheric mass using geopotential heights derived from the ECMWF global circulation model (GCM). We will evaluate this correction using GPS occultation data, which are not assimilated into the GCM and are thus independent measures of atmospheric mass. We will develop an analysis technique for deriving the atmospheric parameterization of refractivity difference that minimizes the mass difference (for conservative estimation of atmospheric mass errors in ECMWF), and will also investigate methods for reducing the water vapor ambiguity in conversion of refractivity to mass. We will test for errors in the ECMWF numerical model outputs, particularly in the polar regions and over the southern hemisphere where the GCM assimilates very sparse in situ measurements. We will also evaluate the uncertainties associated with converting refractivity structure to geopotential height, and examine whether algorithms for this mapping can be improved by exploiting stochastic properties of atmospheric variables and/or in situ measurements of pressure. Then we will compare geopotential heights from SAC-C, CHAMP and GRACE occultation data with ECMWF geopotential heights. If the differences are large and can be confidently attributed to errors in the ECMWF geopotential height fields, we will examine whether occultation data can be used to improve the GRACE atmospheric mass correction.

Wahr, John
University of Colorado Boulder

Hydrological and Oceanographic Applications of GRACE

Our work will involve using the time-variable gravity fields from GRACE to study various hydrological and oceanographic processes. During the first year we will focus on comparing the general spatial and temporal patterns of the GRACE mass estimates with those predicted using hydrological and oceanic models, to help assess the GRACE data as well as to obtain an initial validation of the broad-scale features in those models. During the succeeding years, and as the GRACE fields continue to improve, we will use those fields to look at such things as changes in the water storage, as well as precipitation minus evaporation, over large (greater than 200,000 km²) river basins; changes in snowpack in northern latitudes, and in the total water stored in regions with large underground aquifers; bottom pressure variations over the world's oceans; changes in the distribution of oceanic heat storage (by combining with Jason altimeter data); and fluctuations in deep ocean currents.

Wu, Xiaoping
Jet Propulsion Laboratory

Ice Mass Variations and Earth Rheology - A Global Inverse Approach Using Gravity, Topography and Sea Level History Data Combination

We have an overall objective of studying present-day surface mass variations, historical deglaciation, and mantle viscosity using a combination of time-variable gravity, topography, and relative sea-level (RSL) records.

In the first year, we seek to use seasonal GPS inferred surface load to compare and calibrate low-degree GRACE time-variable gravity data. We will also use a global inverse algorithm to estimate geographic surface mass re-distribution.

Over the three year period, we will develop a global simultaneous inverse algorithm to estimate all major contributing geophysical parameters using secular gravity, surface deformation, Earth orientation, and RSL data.

Presentations

GRACE

Gravity Recovery and Climate Experiment

A Response to over 3 Decades of Recommendations by the Scientific Community for a Dedicated Gravity Mission

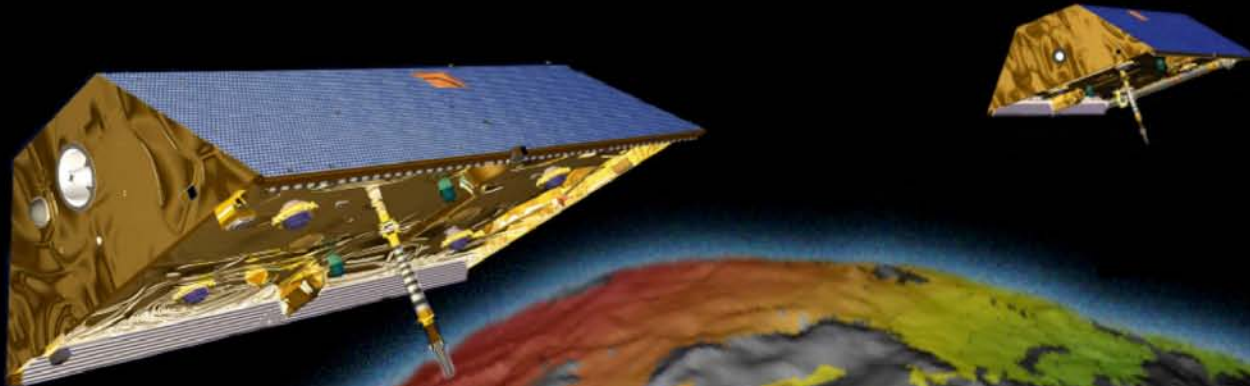

Williamstown 1969, NASA
Elmau 1979, ESA
Eric 1985, IAG
Coolfront 1991, NASA
National Research Council 1997



GRACE

GRAVITY RECOVERY AND CLIMATE EXPERIMENT

The GRACE Mission: Status and Early Results

Byron D. Tapley
Center for Space Research
University of Texas at Austin

Christoph Reigber
GeoForschungsZentrum
Potsdam, Germany

First Grace Science Team Meeting
Austin, Texas, USA
October 8-10, 2003



Gravity & Earth System Science (1)

Measurements of the Earth's gravity field from space are important in understanding global mass variations in the Solid Earth-Oceans-Atmosphere System

Glaciology: (gravity+ice-sheet altimetry+in-situ)

Polar ice sheet mass variations
Global sea level change
Post-glacial rebound

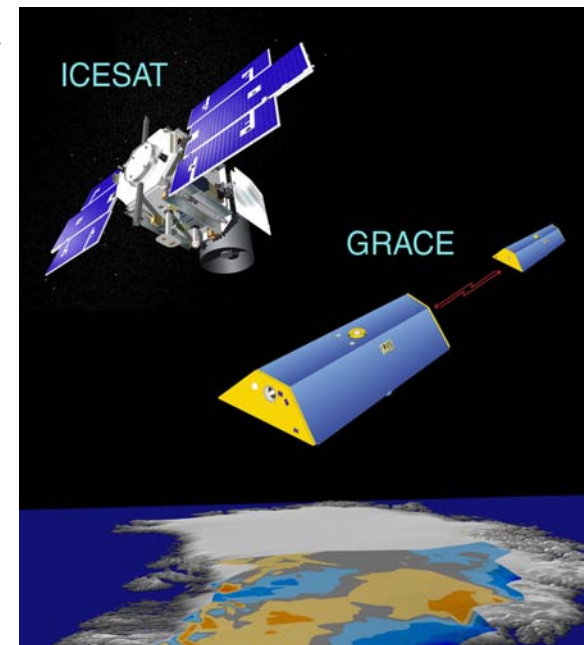
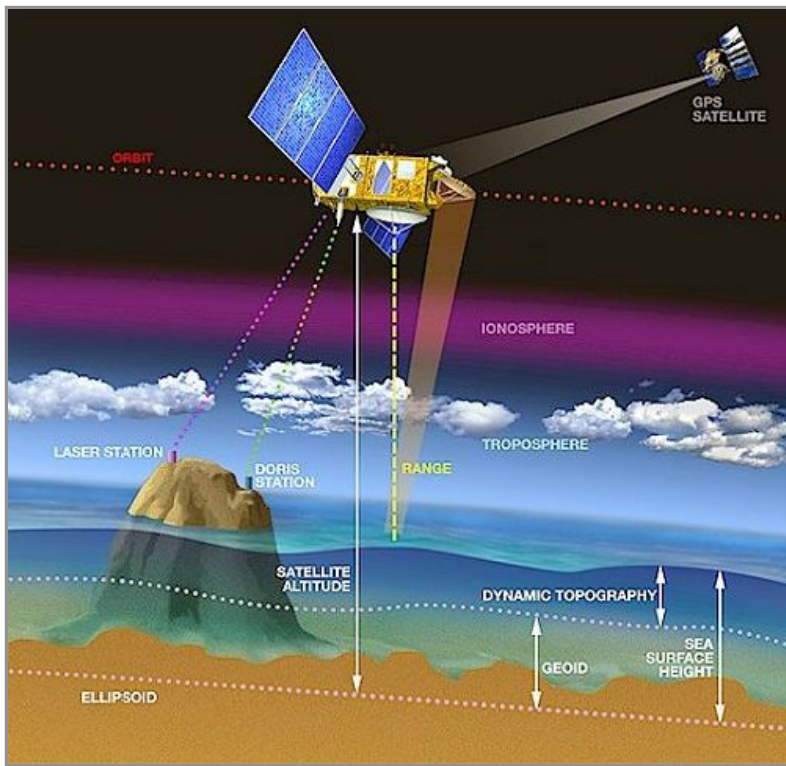

Oceanography: (gravity+altimetry+insitu)

Upper ocean heat content and heat flux
Deep ocean currents and mass transport
Improved altimeter satellite orbits
Long term sea-level change
Absolute surface currents

Gravity & Earth System Science (2)

Hydrology: (gravity+in-situ data+model)

Evapo-transpiration

Soil moisture change

Aquifer depletion

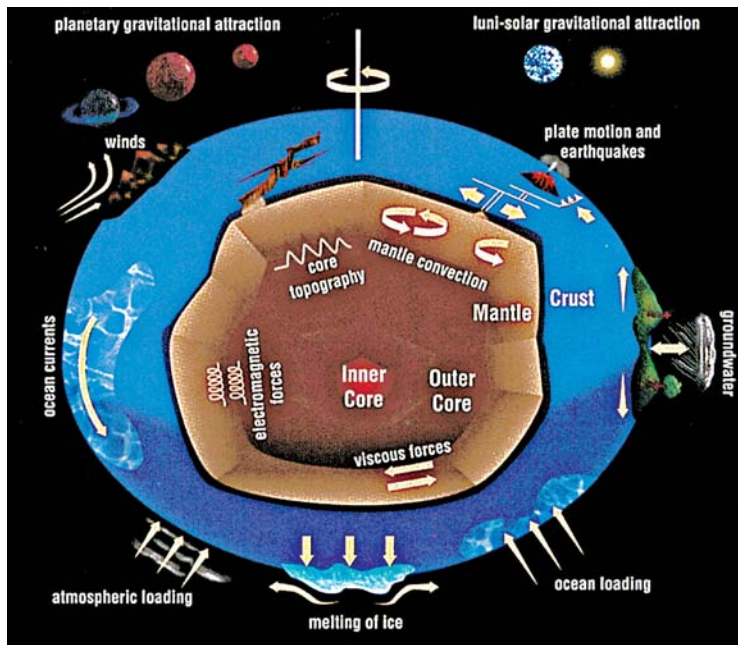
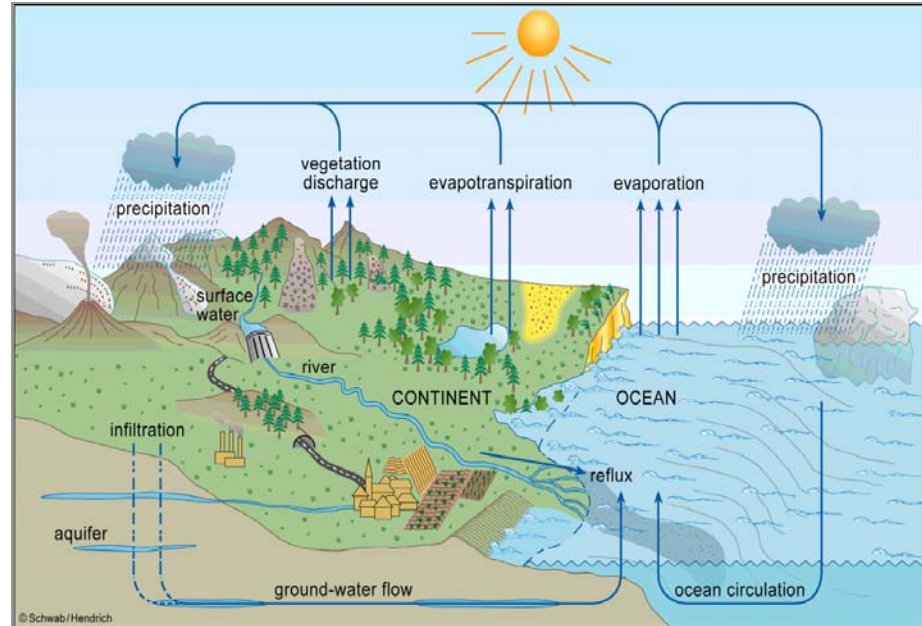

Solid Earth Sciences: (gravity+magnetics+in-situ data)

Mantle & lithospheric density variations

Mantle viscosity

Continental boundaries

Core modes

Geodesy: (gravity+SLR+GPS+VLBI)

Geocenter motion due to mass transport

Earth orientation and angular momentum transfer

Global reference geoid for gravity data

Improved geodetic satellite orbits

GRACE MISSION

Science Goals

High resolution, mean and time variable gravity field for Earth System Science applications.

Mission Systems

Instruments

- HAIRS (JPL/SSL/APL)
- SuperSTAR (ONERA)
- Star Cameras (DTU)
- GPS Receiver (JPL)

Satellite (JPL/Astrium)

Launcher (DLR/Eurockot)

Operations (DLR/GSOC)

Science (CSR/JPL/GFZ)

Orbit

Launched: March 17, 2002

Initial Altitude: 500 km

Inclination: 89 deg

Eccentricity: ~0.001

Separation Distance: ~220 km

Lifetime: 5 years

Non-Repeat Ground Track, Earth
Pointed, 3-Axis Stable

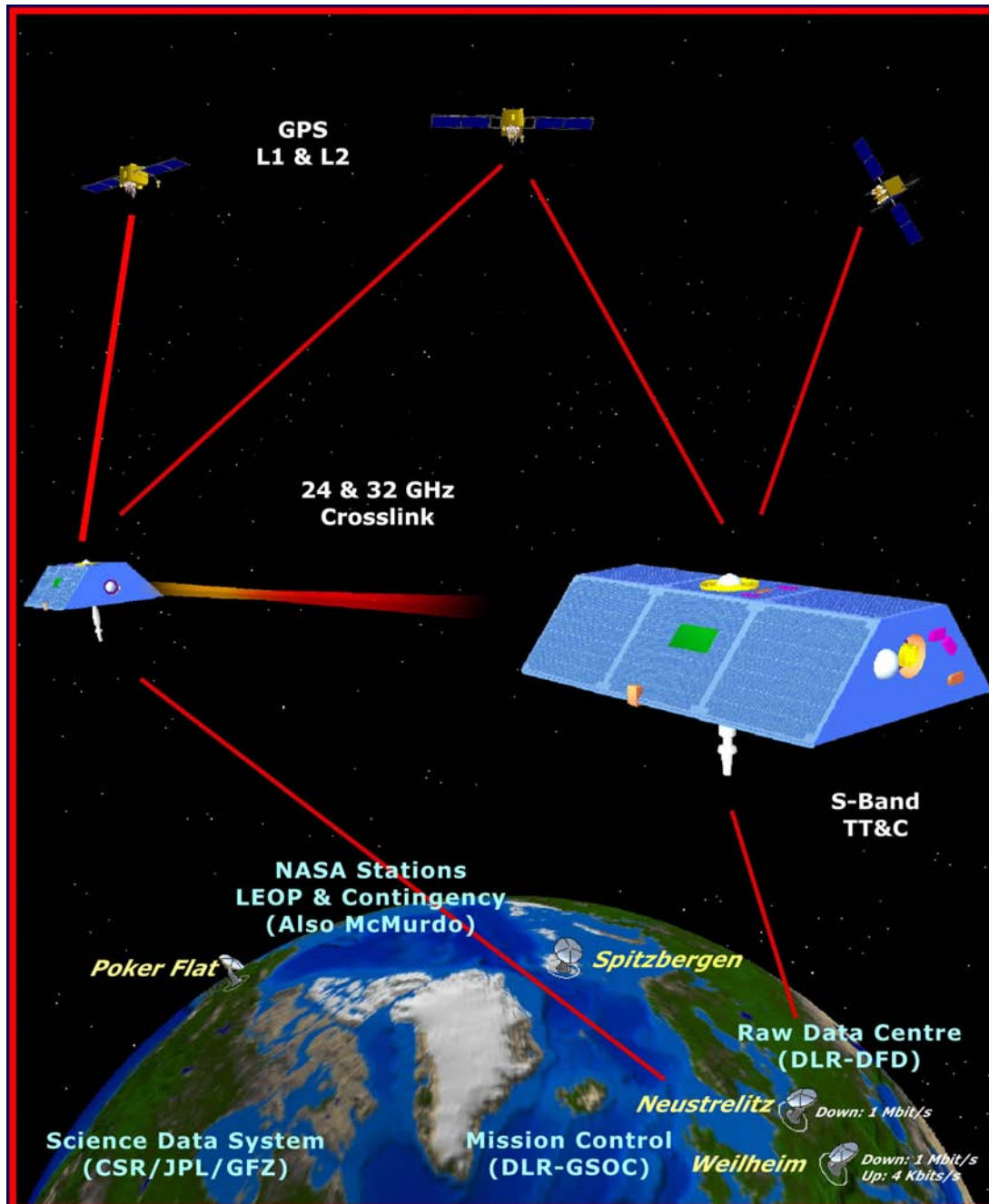

GRACE Project Status

- **Spacecraft & System**
 - Launched 09:21 UTC, March 17, 2002
 - Achieved nominal orbit
 - Commissioned on May 14, 2003
 - CoM Adjustment Completed (~30 microns)
 - Successful K-Band Bore-sight Calibration
 - Loss of some redundancy on GRACE-1
 - Satellites currently in Validation Phase and collecting excellent science data
- **Mission Operations**
 - GSOC successfully operating twin satellites in a multi-mission environment
 - Over 99% science data recovered from satellites (science & housekeeping)
- **Science Data System (CSR, JPL, GFZ)**
 - Initial gravity model determinations
 - Time Variable Effects
 - On-going assessment of the flight segment
 - Measurement Evaluation



GRACE Mission Data Flow

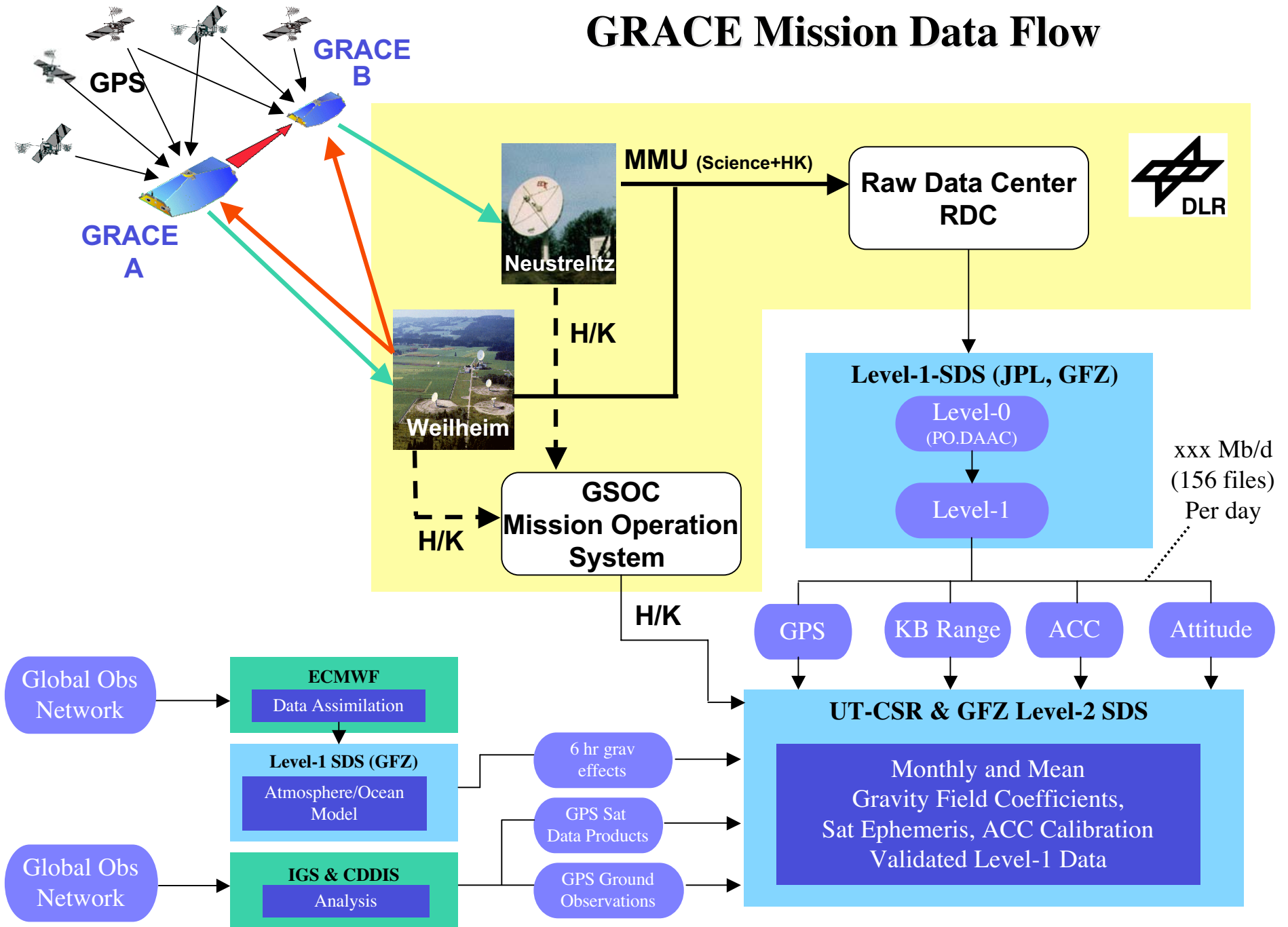

GRACE: Measurement Concept

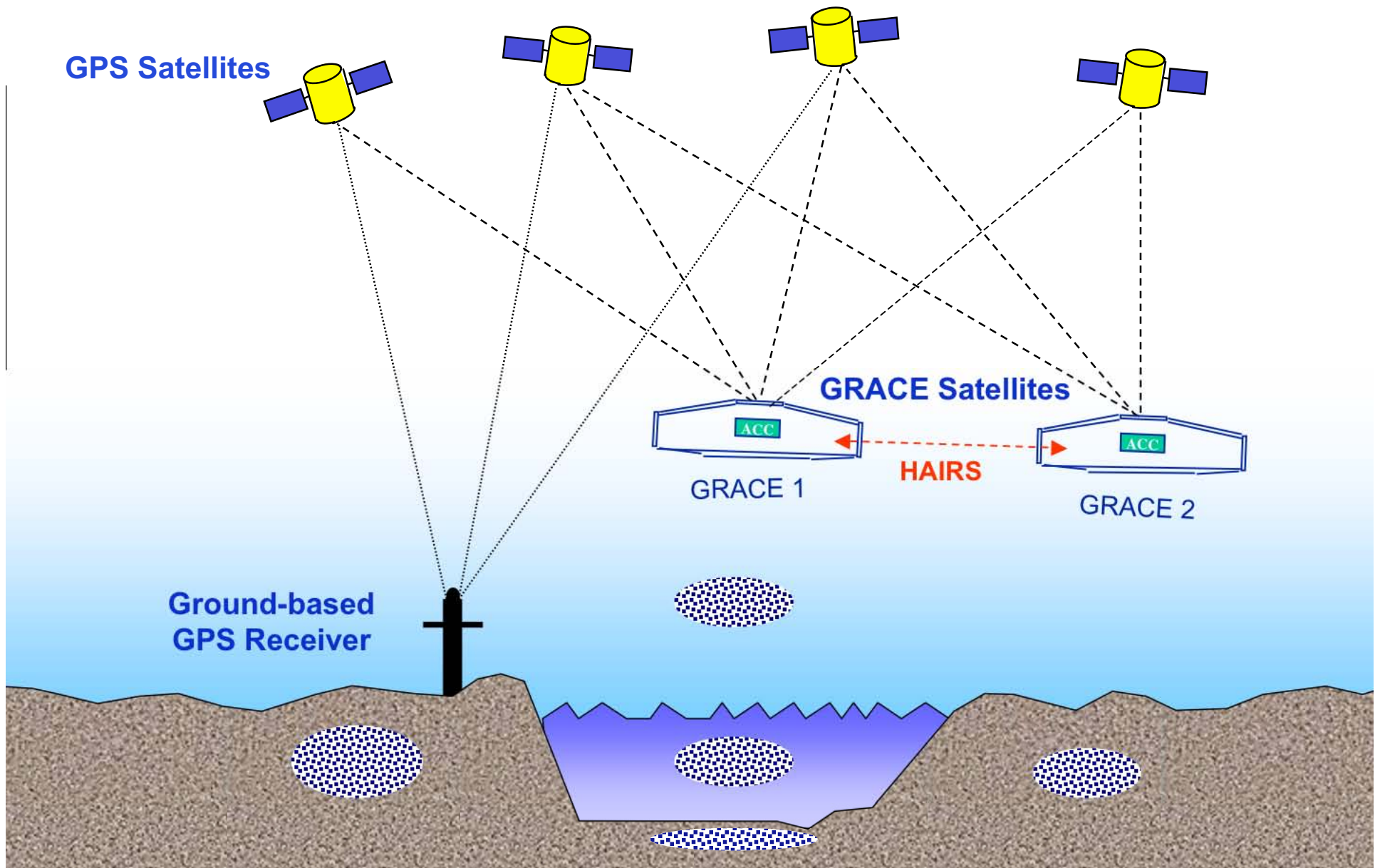

High Accuracy Inter-Satellite Range

Inter-Satellite Range from KBR

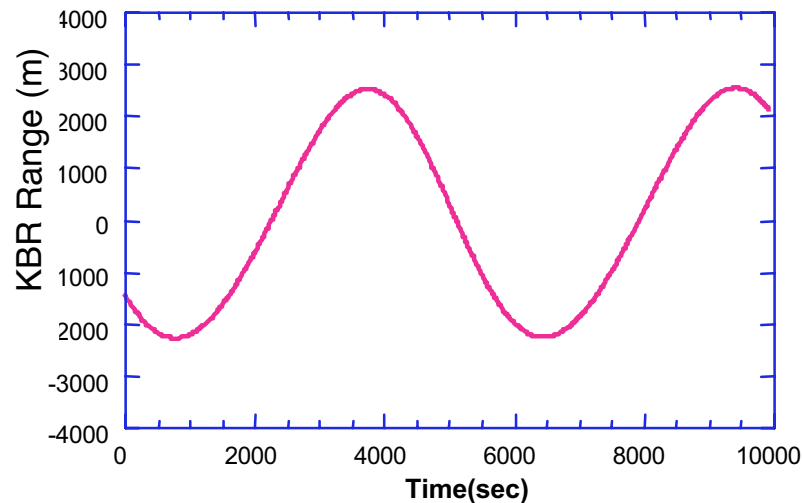

Principal variations of ± 2 km in relative distance is at orbital period

Range variations must be measured to ~ 1 ppb

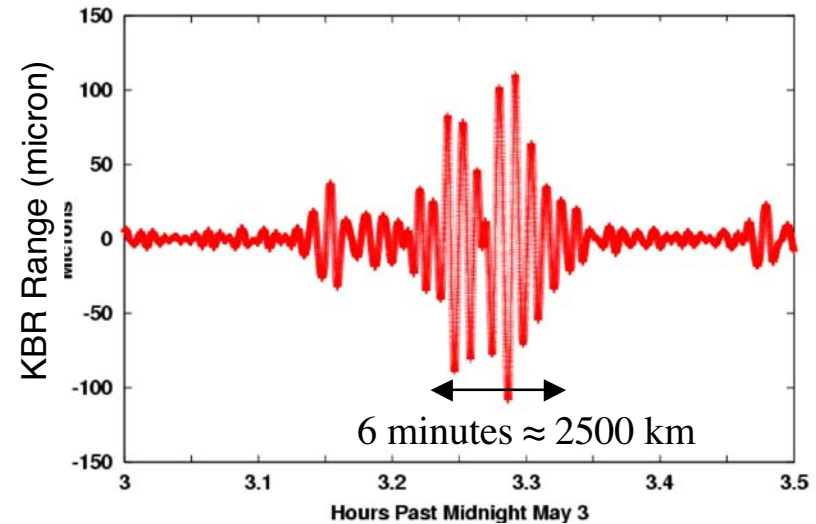

Ascending pass crossing Himalayas (80° longitude, $18-40^\circ$ latitude)

Low frequency perturbations removed to show local gravity variations in KBR range at micron level

High Frequency Content of KBR Dual One-Way Range Measurement (2)

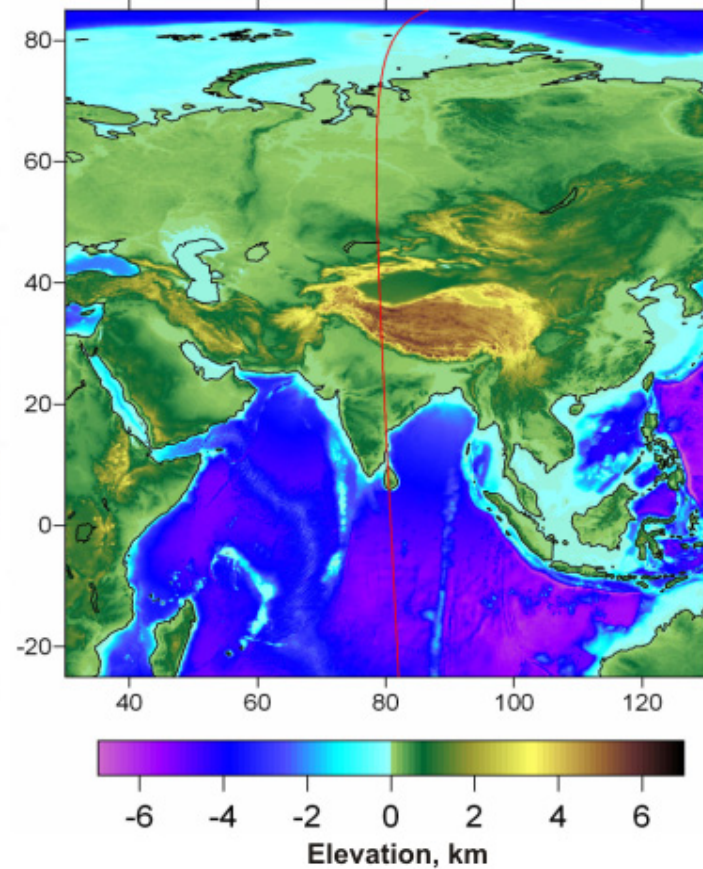
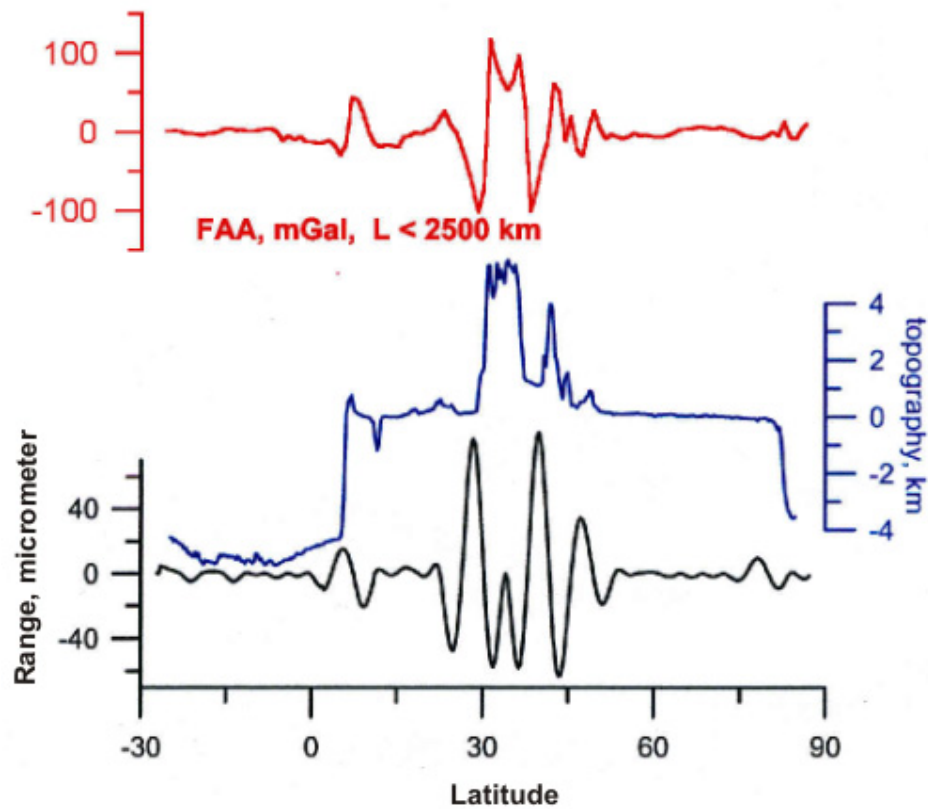

Preliminary GRACE Solution

- 111 days of GRACE data (Apr-Nov, 2002)
 - KBR range-rate and GPS phase data
 - Attitude from star camera
 - Non-gravitational accelerations from SuperStar accelerometer
- Estimated parameters
 - Initial conditions for daily arcs
 - Accelerometer bias and scale factors
 - KBR biases
- Estimate 120x120 using only data from GRACE
 - No 'Kaula' constraint, no other satellite information, no surface gravity information and no other *a priori* conditioning

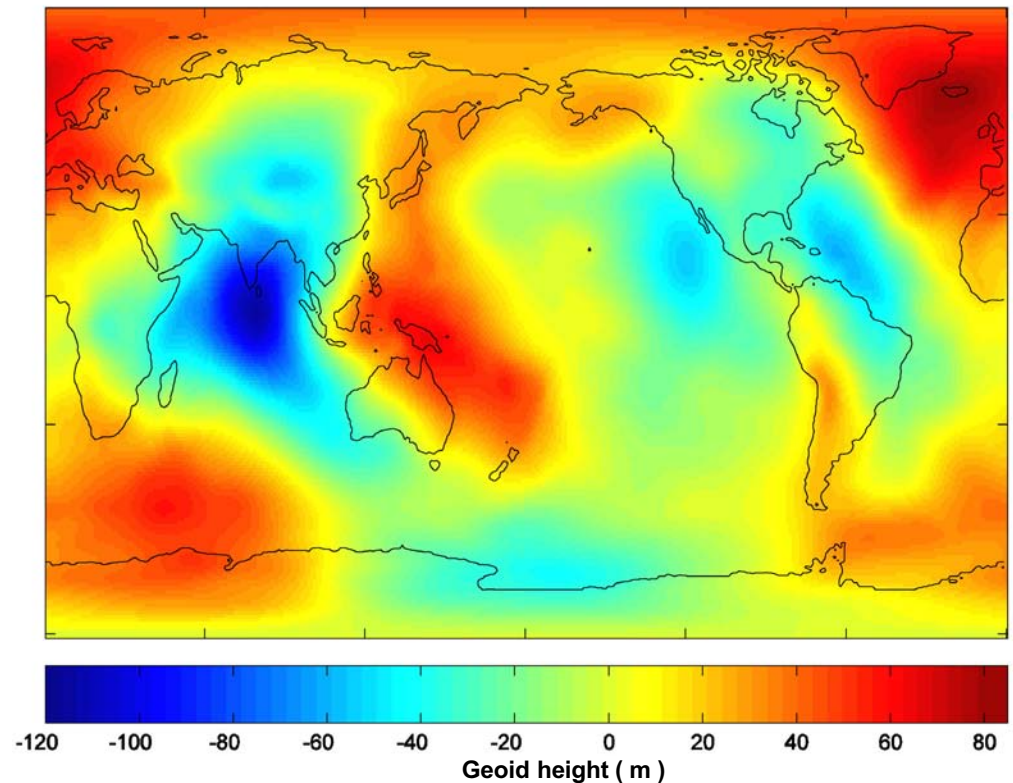

The geoid is the level (constant gravity) surface that best coincides with mean sea level

The geoid height varies by ~200 m, but oceanographic applications need this to be determined to cm accuracy

Progress in Measuring Gravity from Space

Decades of tracking to geodetic satellites

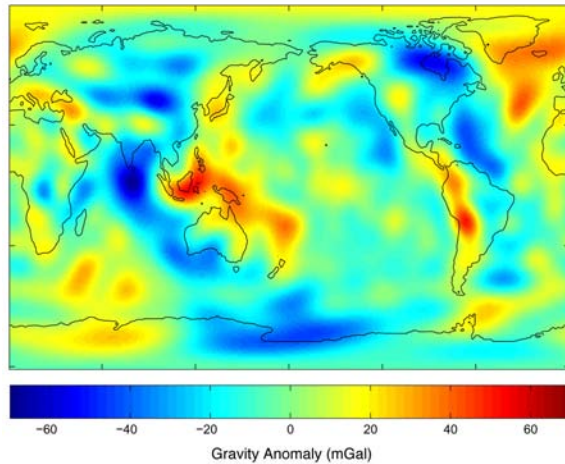

111 days of GRACE data

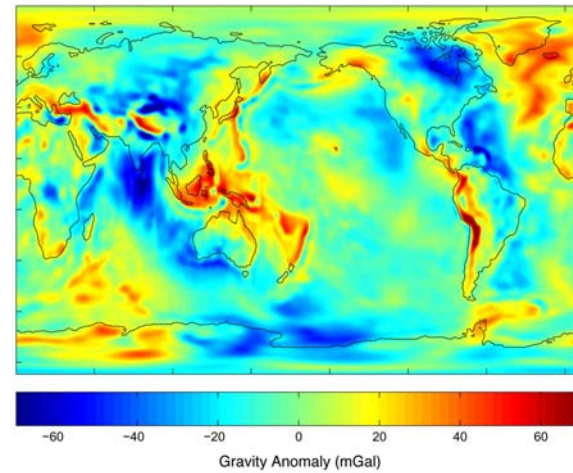

Geoid error estimate for EGM96*

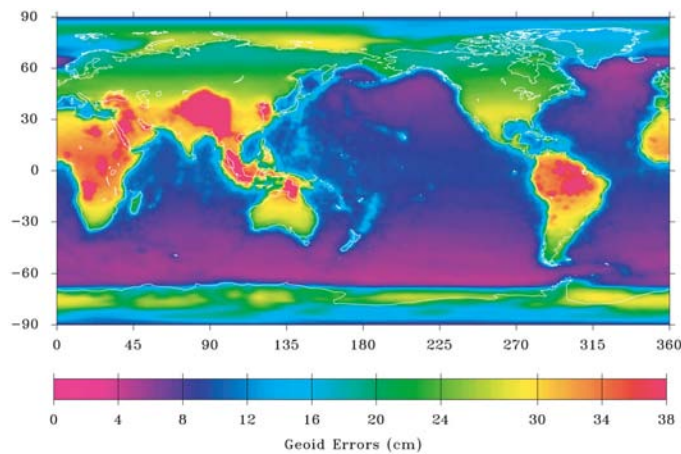

Errors as large as 38 cm

Geoid error estimate for GGM01S*

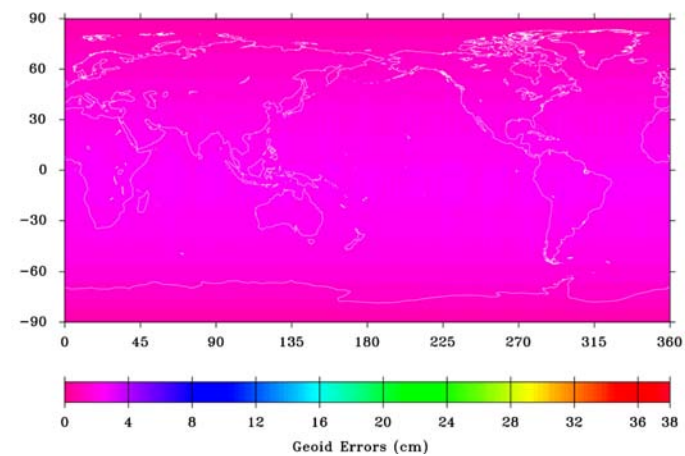

Errors at most 1-2 cm

* at ~300 km resolution

Geoid Differences between Grace Model and EGM96

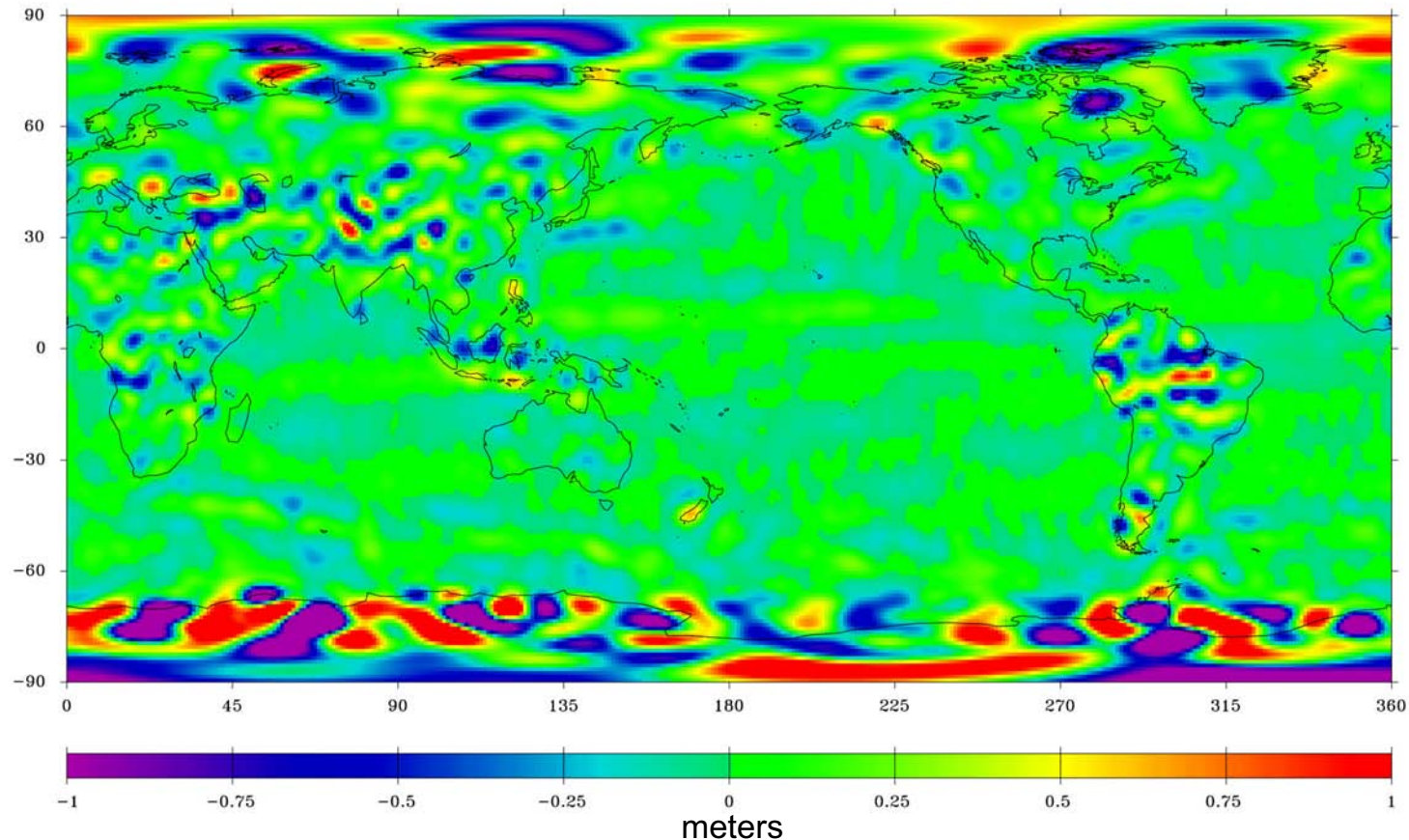

The differences are largest in the areas that were previously less well-determined, as would be expected if GRACE improved the geoid model.

Scale is +/- 1 m.

Differences in some areas exceed 1 m.

Compared to degree and order 90.

Gravity as Seen from Space by GRACE

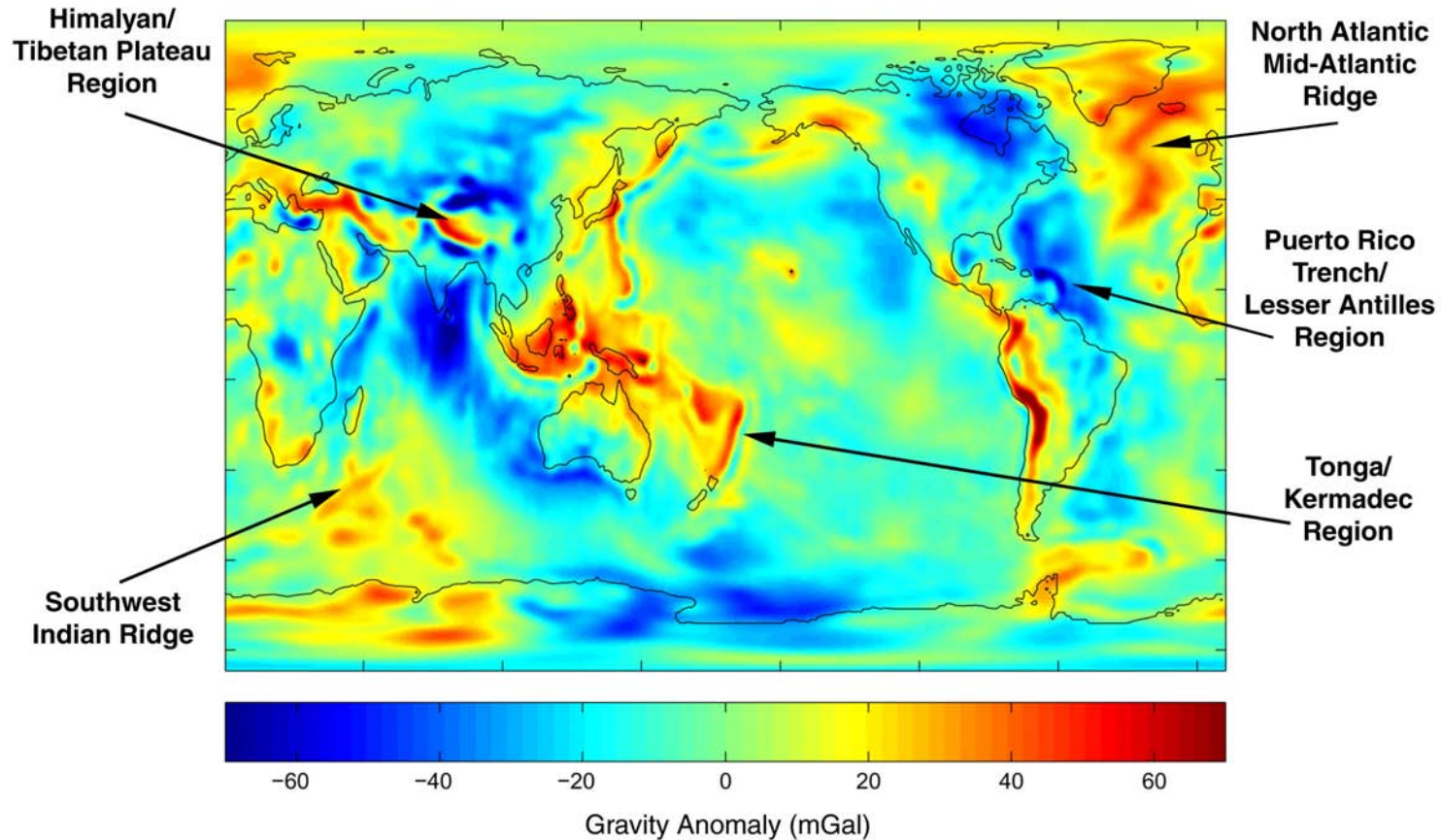

These detailed geophysical features are being detected by GRACE with no surface gravity inputs and no satellite altimetry

Dynamic Ocean Topography Inferred from a GRACE-only Geoid

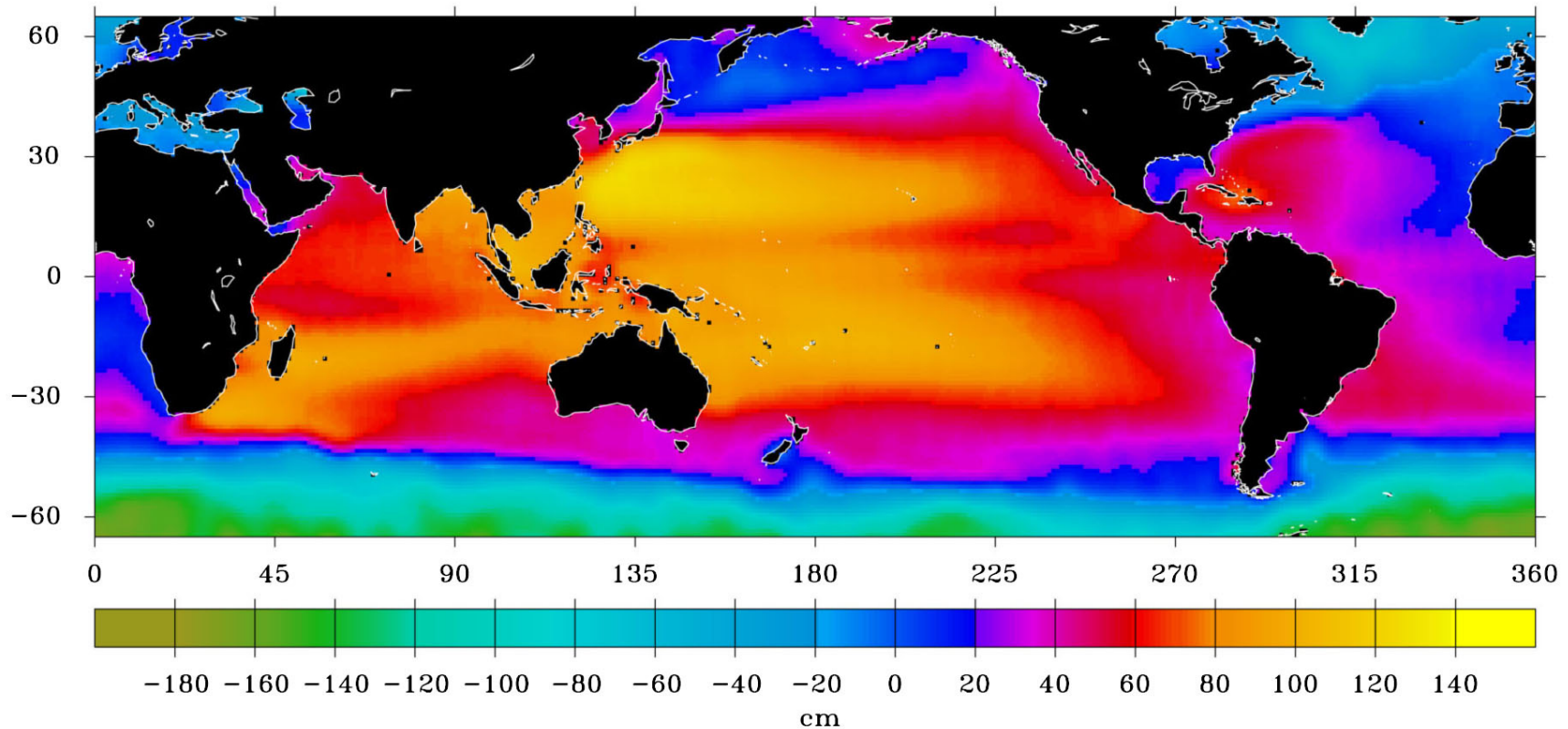

The dynamic ocean topography is the difference between the mean sea surface (observed from altimeter data) and the geoid. This difference is caused by the ocean currents.

With no currents, the ocean surface would coincide with the geoid.

Zonal Geostrophic Currents

Determined from η_{rel} to 3000-4000m
(η_{rel} calculated from WOA by V. Zlotnicki)

CSRMSS98 - EGM96

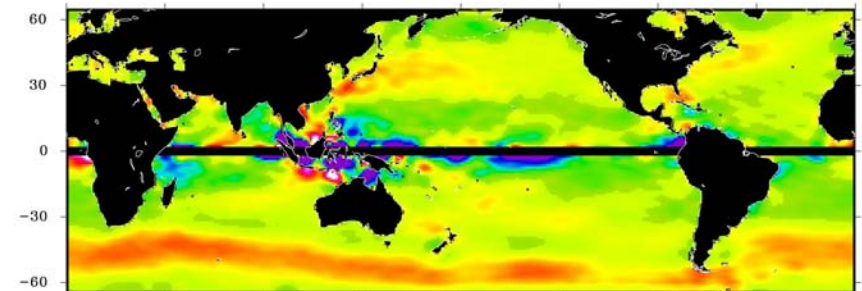
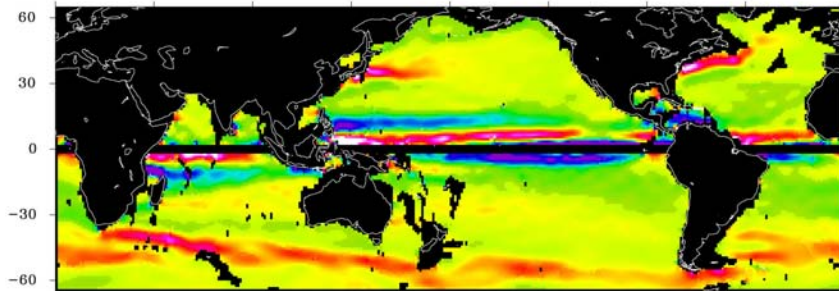

CSRMSS98-GGM 01

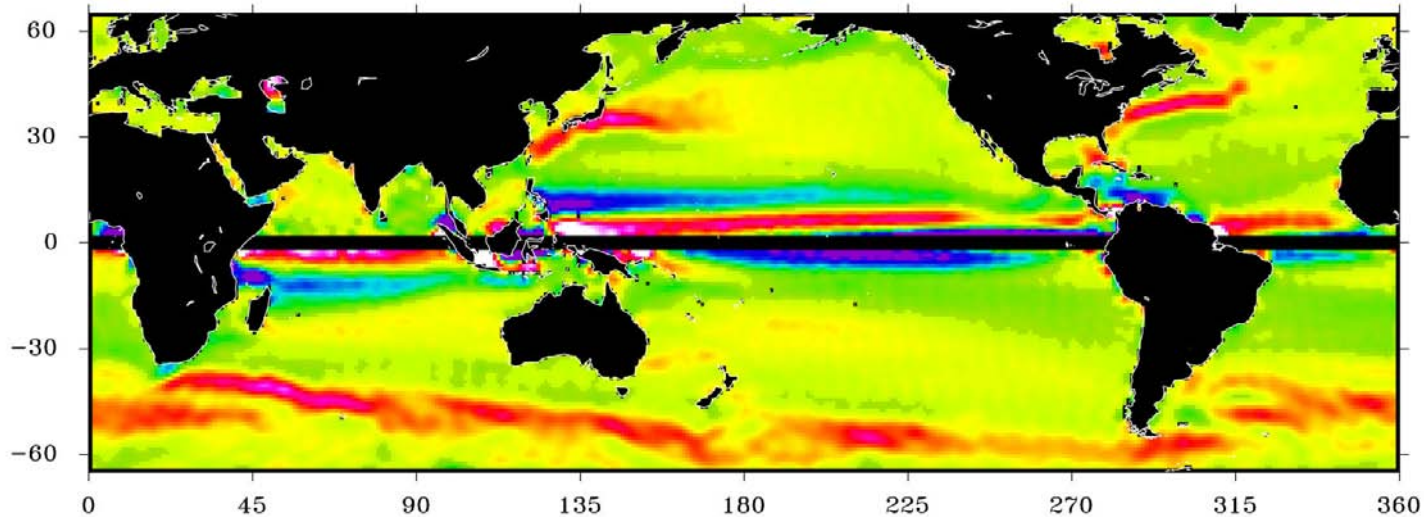

+ eastward

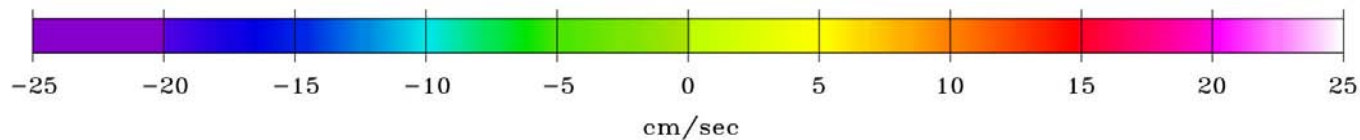

Time variable gravity comparison

August 2002 to April 2003

GRACE using current data release

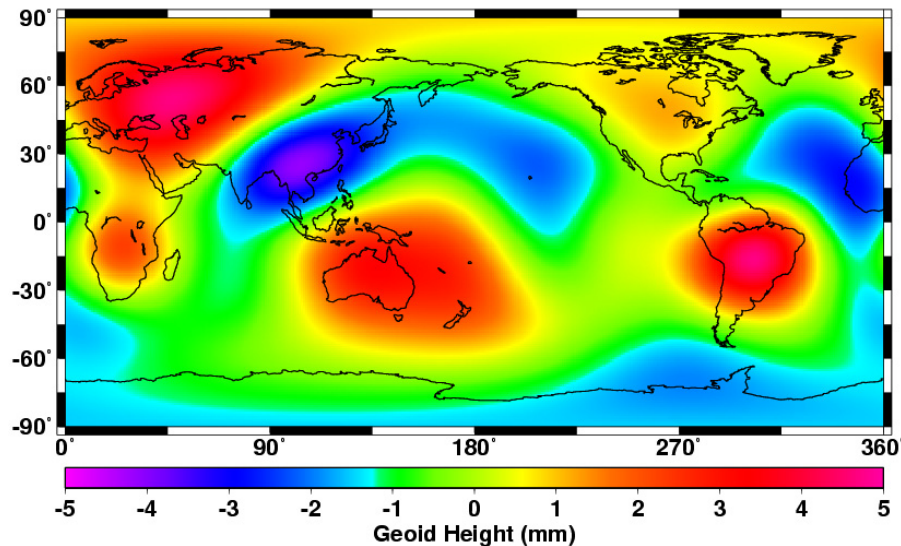

August 2002 to April 2003

Hydrology model

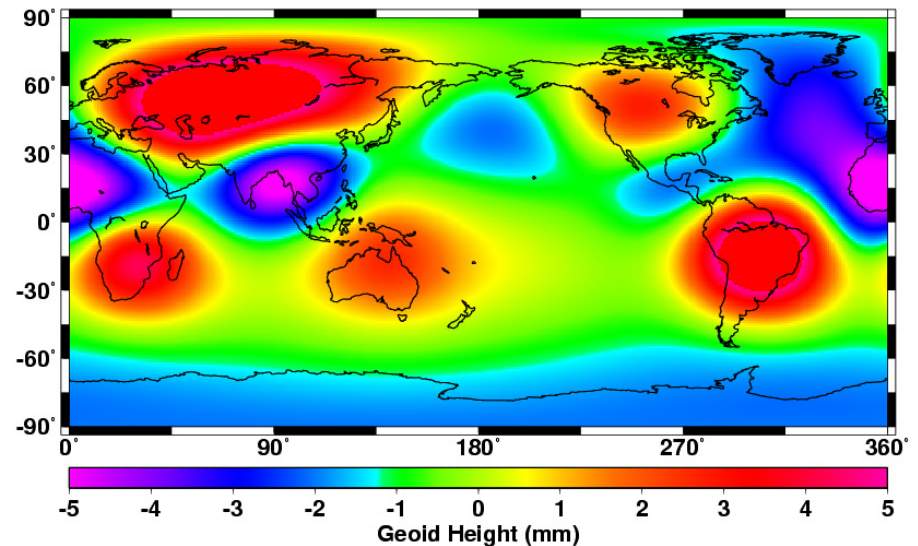

Geoid height anomaly (mm) - J2 removed, 2000 km smoothing

GRACE Performance

The GRACE models are a significant improvement over previous models in the degree range of ~4-90.

However, work remains to reduce the formal errors to the baseline level, and to reduce the true errors closer to the formal errors.

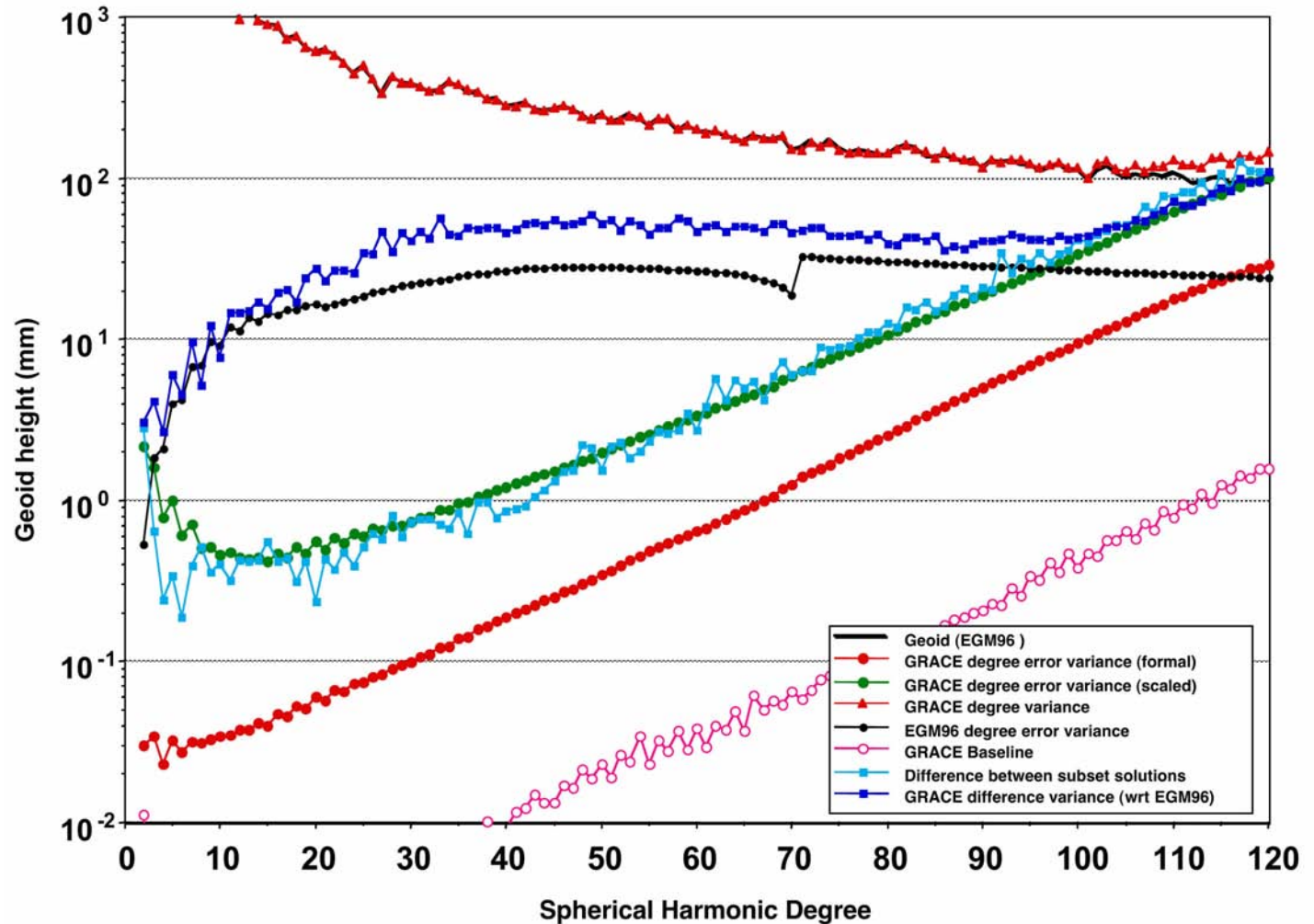

Progress in GRACE Gravity Solutions

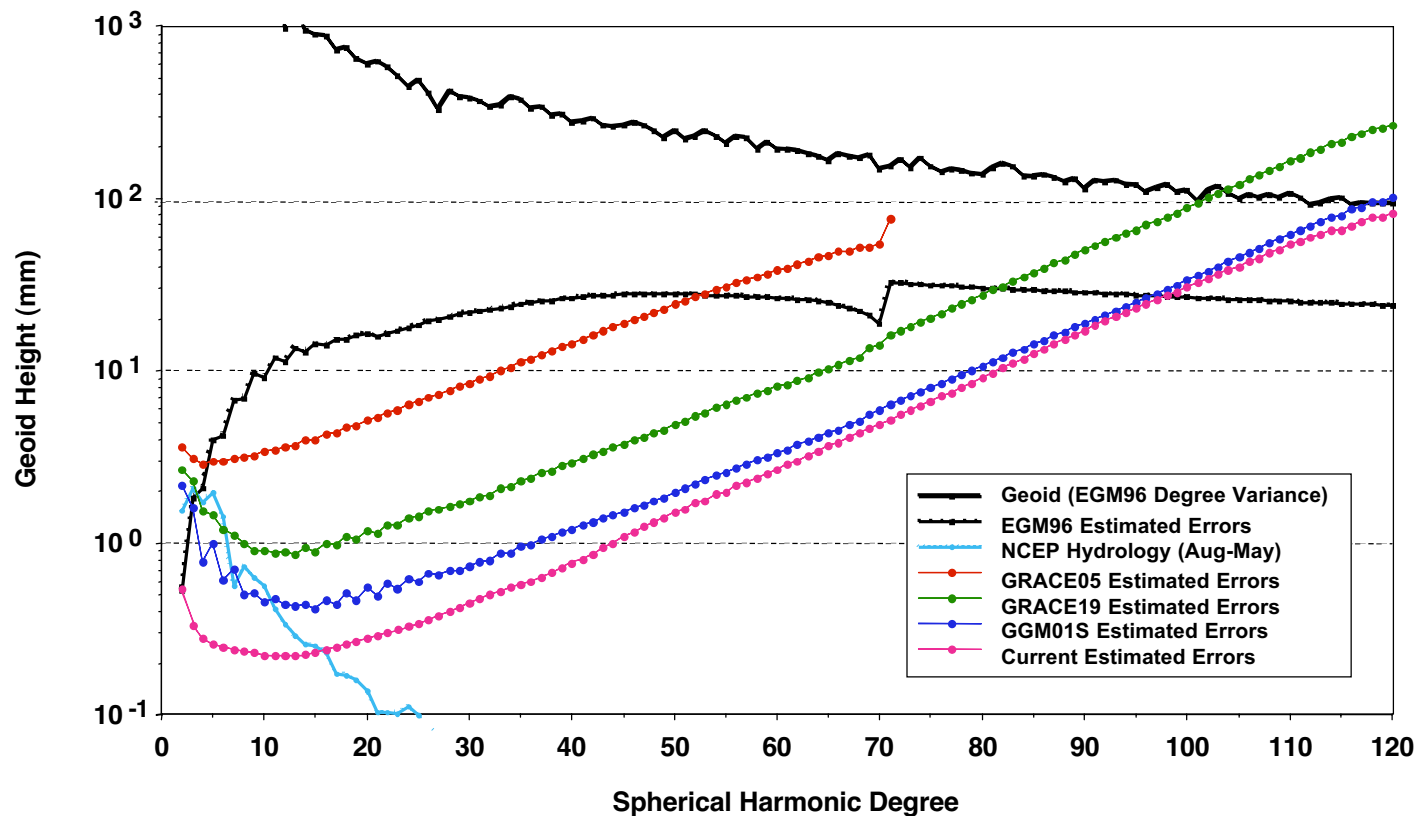

- As Level-1 and Level-2 processing techniques have improved, the estimated error has improved.
- Low degree error estimates for GGM01S, based on subset solutions, was probably reflecting real signal, not error, and thus may have been pessimistic at the low degrees.
- Newest error estimate was based on independent solutions for the same month of data.

The GRACE Mission: Improvements to Achieve Baseline Mission

Satellite Operation

- Flight Software Improvements

- Improved AOCS Performance

Level 1 Data Processing Improvements

- Improved Filter/Interpolation

- Improved AOCS Processing

Level 2 Data Processing Improvements

- Error Parameters

- Measurement Modeling

- Solution Methodology

Level 3 Analysis

- Solution Evaluation

- Improved Models

GRACE DATA PROCESSING PLAN

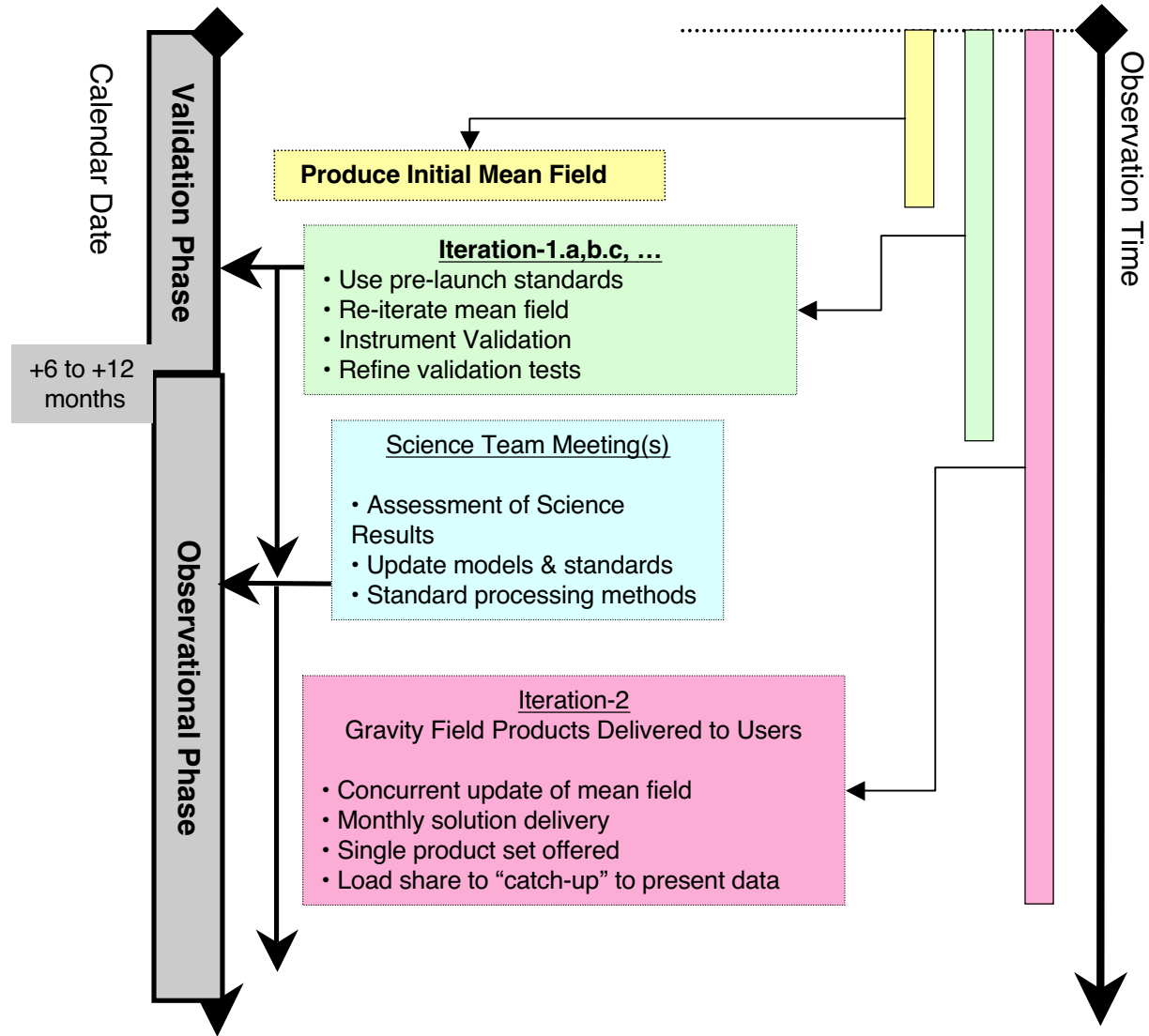

Data Release Plans

Level 2 Data

Preliminary Data Release

Initial Mean Fields: July 15, 2003

Monthly Solutions distributed over the first fourteen months
Released to Science Team for evaluation

Release Epoch: November 11, 2003

Science Team Evaluation Period: 11/11/03 - 5/14/04

Final Data Release: May 14, 2004

Level 1B Data

Preliminary Data Release

Three days covering period April 25, 26, and 27, 2003

Released to two US and two European Centers for evaluation

Science team release

Level 1b data for previously released Level 2 fields

Release Date; January 16, 2004

Science Team Evaluation Period: 1/16/04 - 5/14/04

Final Data Release May 14, 2004

Evaluation of GRACE Performance

- **GRACE gravity model improvement for wavelengths between 500 and 15,000 km varies between a factor of 10 to 50**
 - Altimeter determination of ocean currents dramatically improved
 - Prominent geostrophic currents in the proper places with the correct magnitude
 - Evidence that MSS error (not geoid error) may be limitation
 - Long wavelength geoid model errors reduced to cm level, globally, for improvement in geodetic applications
 - Improved orbit determination with less geographically corr. Error
 - Current error estimate indicate monthly gravity variations should be resolvable to 1000-2000 km resolution
 - **Satisfaction of Minimum Mission Requirement**
 - Individual monthly solutions from new data release almost satisfy minimum mission (< 1 cm cumulative geoid error to degree and order 70)
 - Combination of several months will meet minimum mission requirements for mean field
-

Conclusions

- **This current solutions provided a strong validation of the mission concept and the satellite/sensor on-orbit performance**
 - **Significant improvement in mean field**
 - **Essentially satisfied Minimum Mission requirement**
 - **Time varying gravity signal has been detected**
 - **Need improved resolution**
 - **There is no evidence of an impediment to achieving the Baseline Mission Performance**
 - **Improved performance will allow monitoring time varying gravity signals with increased spatial resolution**
-



*Some additional remarks from the
European component of the GRACE mission*



Chris Reigber

GeoForschungsZentrum Potsdam

Joint US/European GRACE Science Team Meeting (GSTM),
Oct. 8 - 10, 2003, Austin/Texas, USA





GRACE Mission Status- Co-PI's View

Ground segment operations



1. Mission Operation System MOS functioning satisfactory; Alert system sufficient ?
2. GPS & SLR networks operation ok ;GRACE predicts ok and timely available
3. WHM / NZ station operation ok; Ny Alesund station ready in 03/04 for routine multi-mission operation
4. GFZ's SDS part steadily improving; dealising products timely available
5. Improved level 2 products from improved level 1b data ; preliminary first EIGEN-GRACE1S gravity model was made public
6. GRACE- ISDC on its way to routine operation; full operationality secured for 01/04
7. Atmospheric processor ready for multi- sat RO processing; presently used for CHAMP and SAC- C
8. Computer power increased- but still not adequate for future processing needs
9. First interesting results emerge from analyses in present validation phase and efforts have to be intensified for realizing useful validation campaigns





First Results- Homogeneous EIGEN-GRACE Model Quality

First single satellite derived gravity model with homogeneous quality to medium / high degrees of gravity expansion for various applications

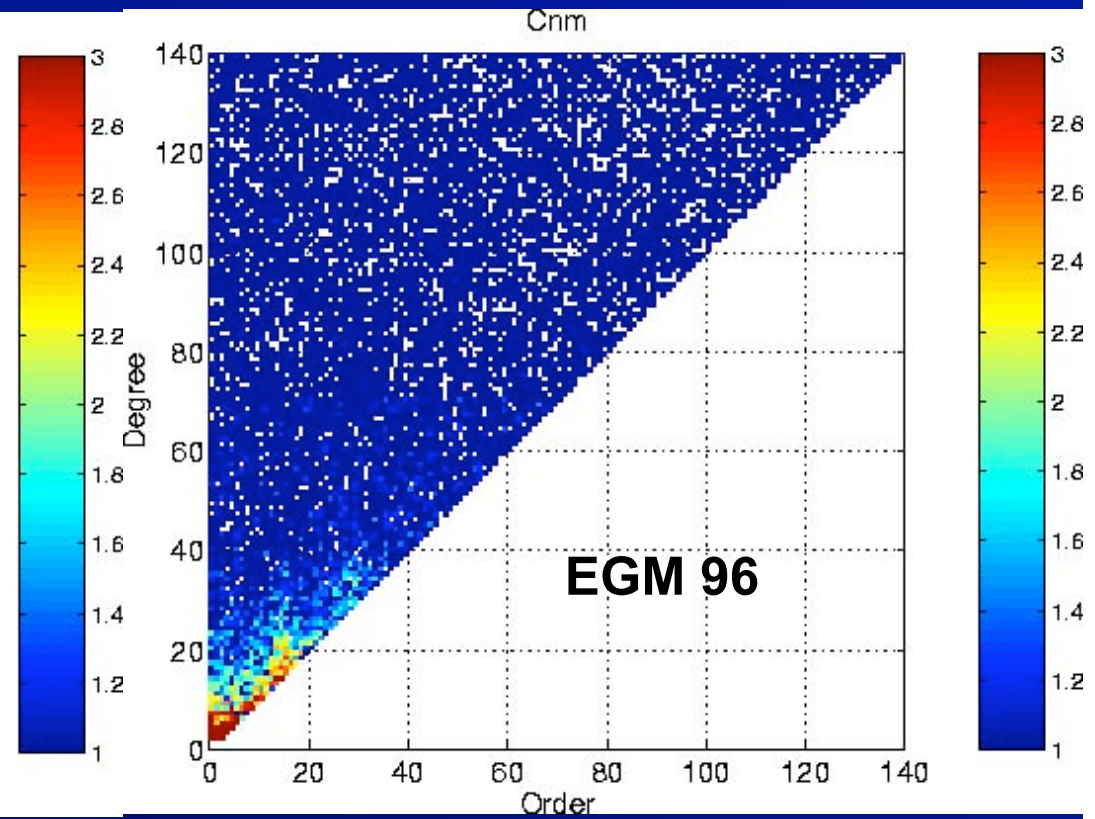
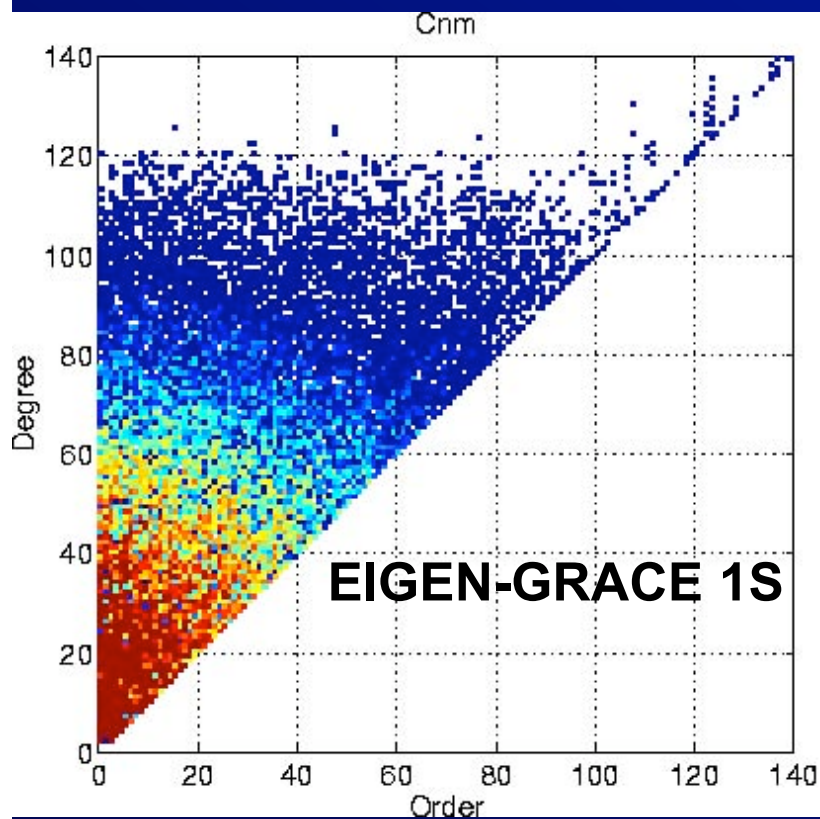



Orbital Fit Results for Geodetic Satellites

SLR resp. GPS phase/SLR RMS (CHAMP, GRACE)



Gravity Model	Starlette [cm]	Stella [cm]	Lageos-1/2 [cm]	GFZ-1 [cm]	Ajis [cm]	ERS-2 [cm]	ENVI [cm]	CHAMP [cm]	GRACE [cm]
---------------	----------------	-------------	-----------------	------------	-----------	------------	-----------	------------	------------

MultiSatComb

GRIM5-C1	2.7	3.1	1.11/1.06	14.7	3.3	5.5	4.5	10.4/62	36.4/217
EGM96	3.2	6.7	1.15/1.15	24.7	4.0	9.2	7.1	10.2/81	19.1/70
TEG4*)	3.7	3.4	1.11/1.09	20.5	3.5	5.7	5.3	1.4/14	5.1/28

CHAMP-only

EIGEN-3p	3.4	6.8	1.15/1.08	13.6	3.4	7.3	15.2	0.6/5.7	2.2/10.1
----------	-----	-----	-----------	------	-----	-----	------	---------	----------

GRACE

GGM01S	2.5	3.6	1.13/1.05	14.5	3.3	5.9	6.3	0.6/6.7	1.4/6.7
GGM01C	2.7	3.4	1.11/1.05	13.5	3.5	6.0	4.8	0.6/6.0	1.3/7.5
GRACE01S	2.5	3.5	1.11/1.05	14.5	3.1	5.7	5.2	0.6/6.9	1.2/6.0
GRACE01Sup	2.8	3.2	1.14/1.07	14.1	3.2	5.6	4.6	0.6/6.3	1.2/5.7

*) includes CHAMP data

None of these arcs was used for the CHAMP/GRACE gravity modeling



First Results- Gravity Field Modeling

Satisfactory agreement of GFZ & CSR 04/03 monthly solution with completely independent processing systems (S/W; models)

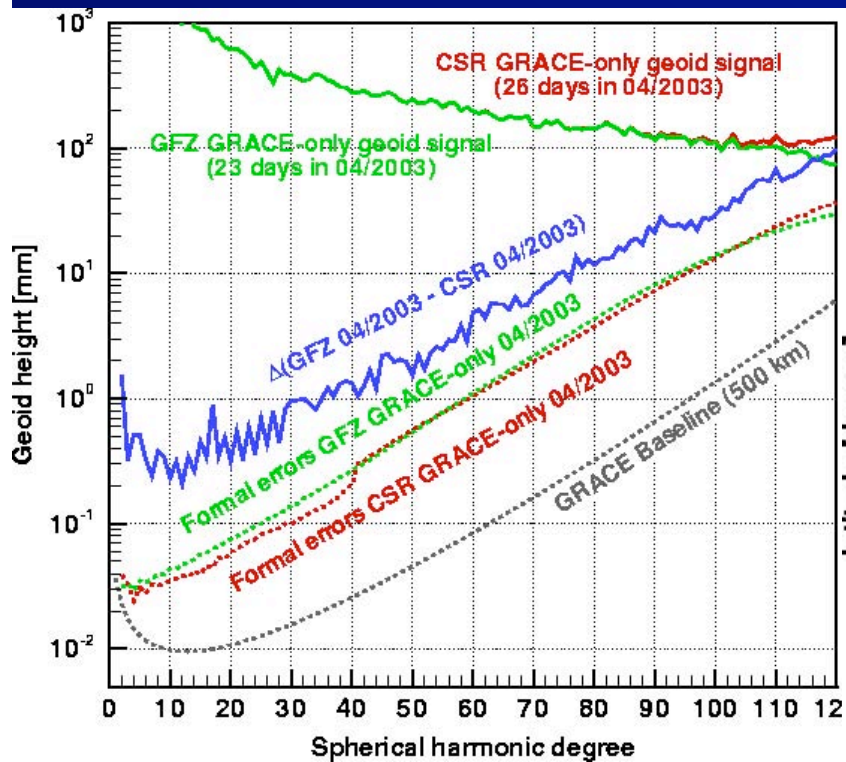

Differences Geoid GFZ 04/2003 - CSR 04/2003 (n=m=10)

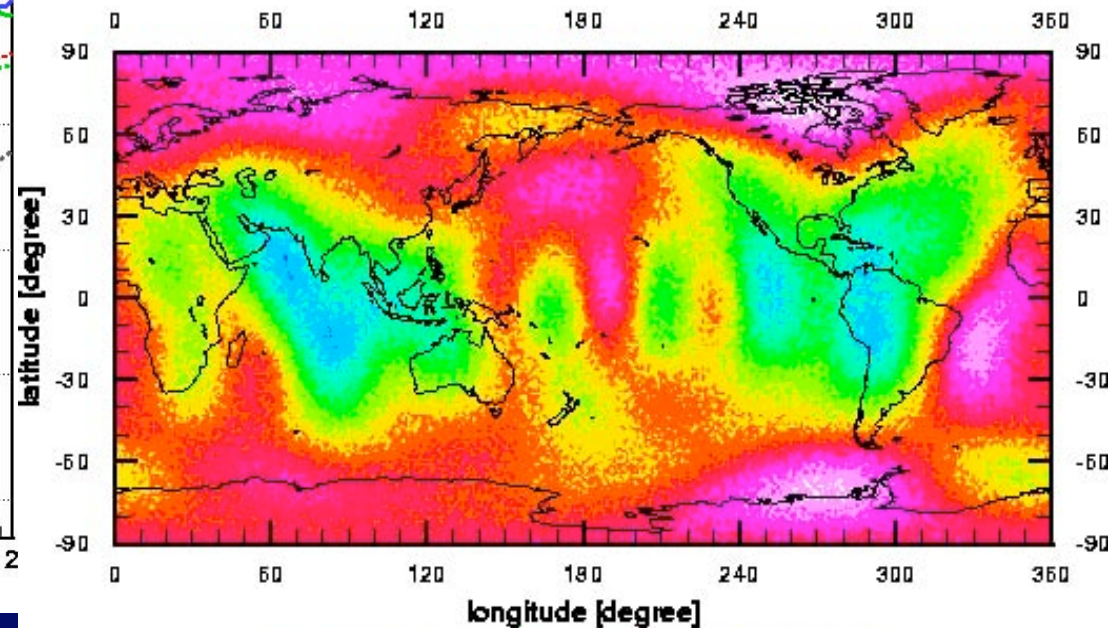



First Results-Oceanography (AWI, GFZ)

First clear oceanographic result from GRACE: ocean model deficiency in southern ocean

BR12- CLS98.2- EIGEN-GR2up
Gauss Filter 650km

AWI OCM BR12
(9 Y Topex/Poseidon SSH, SST,
hydrographic data, 4DVAR)

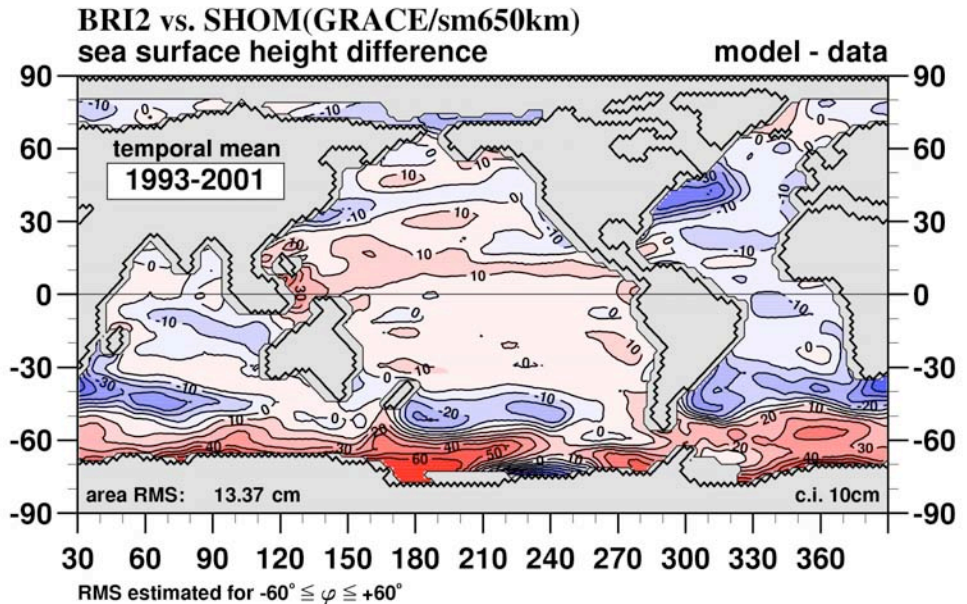
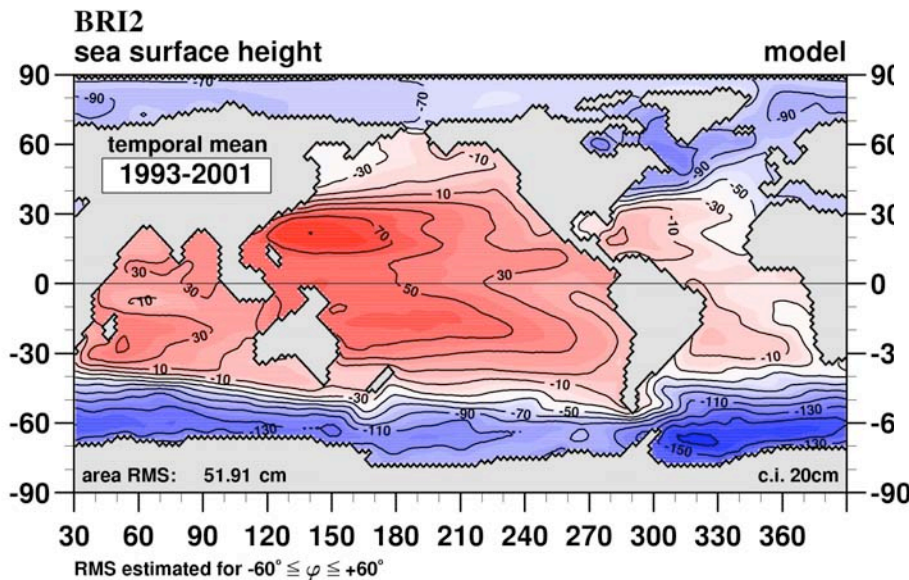

M.Wenzel, J.Schröter, J. Stavena





First Results- Sensitivity to Hydrology



First clear hydrological signal from GRACE model differences

☐ GRACE-only sol. 04/2003 - 08/2002

☐ hydr. Mod. 04/2003 - 08/2002

Differences GRACE monthly solutions 04/2003 - 08/2002
(n = m = 10)

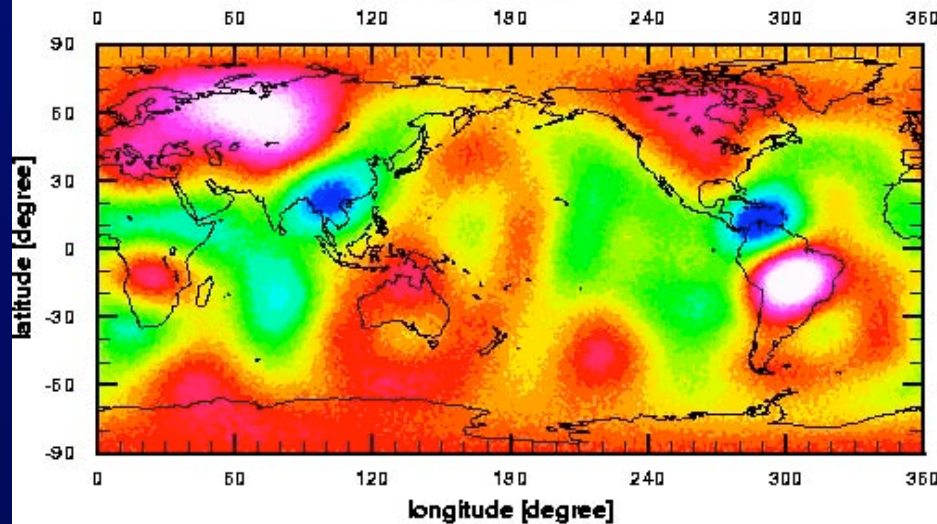

Differences hydrological signal 04/2003 - 08/2002
(n = m = 10)

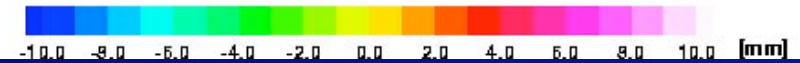
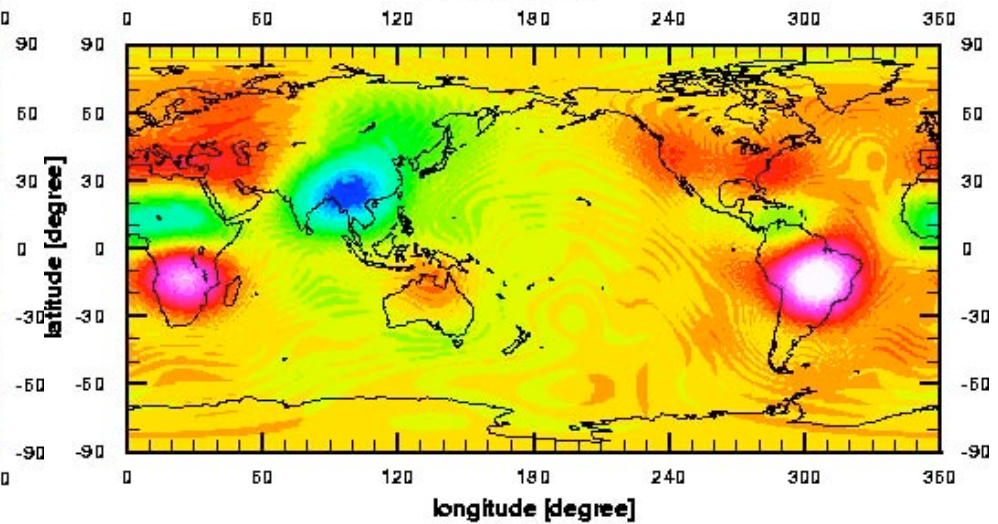

EIGEN- GRACE model difference
separated by 8 months

Huang, Dool, Georgakakis, 1996
Hydrology model difference
separated by 8 months





Time-Variable Gravity - Sensitivity to Hydrology



Hydrology signal clearly visible in EIGEN geoid difference degree variances up degree 10-20

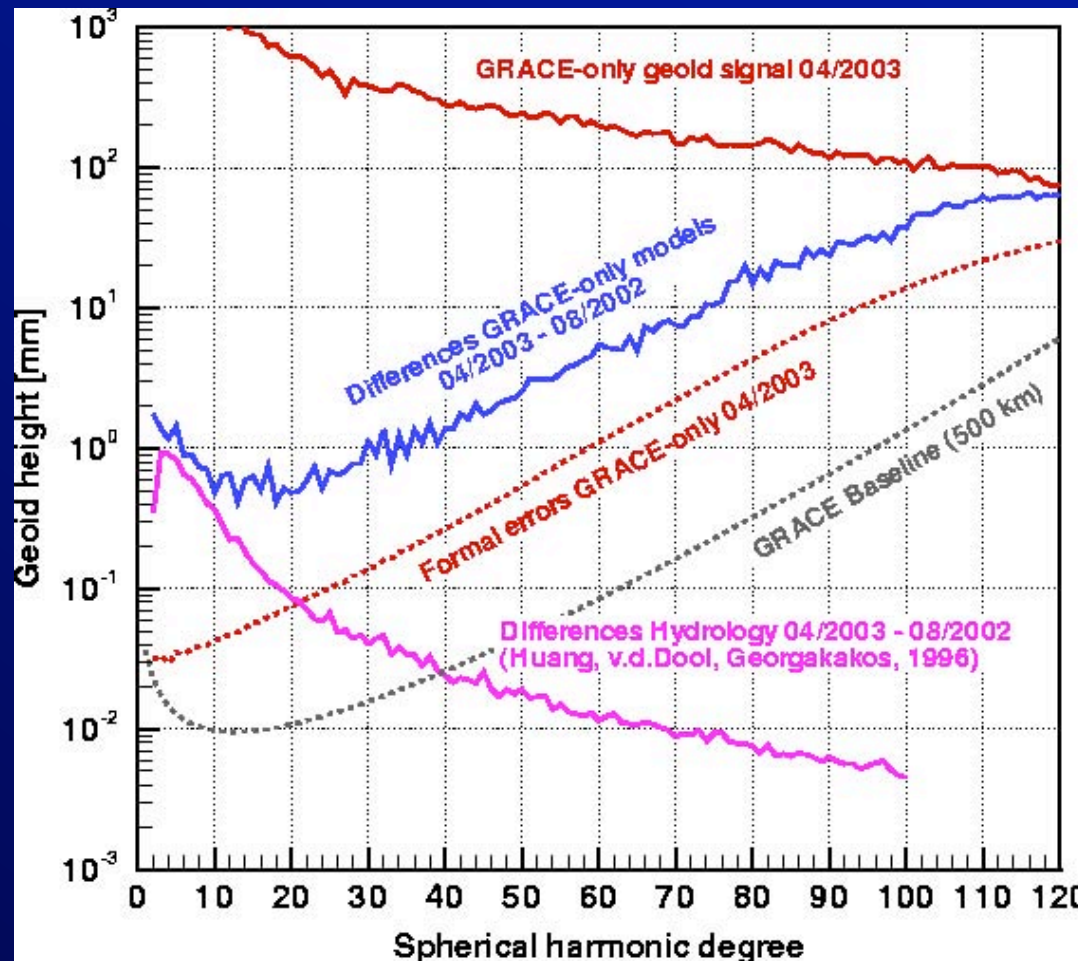



GRACE Time-Variable Gravity - Sensitivity to Hydrology



□ GRACE-only sol. 04/2003 - 08/2002

□ GRACE-only sol. 04/2003 - 08/2002

Differences GRACE monthly solutions 04/2003 - 08/2002
($n = m = 10$)

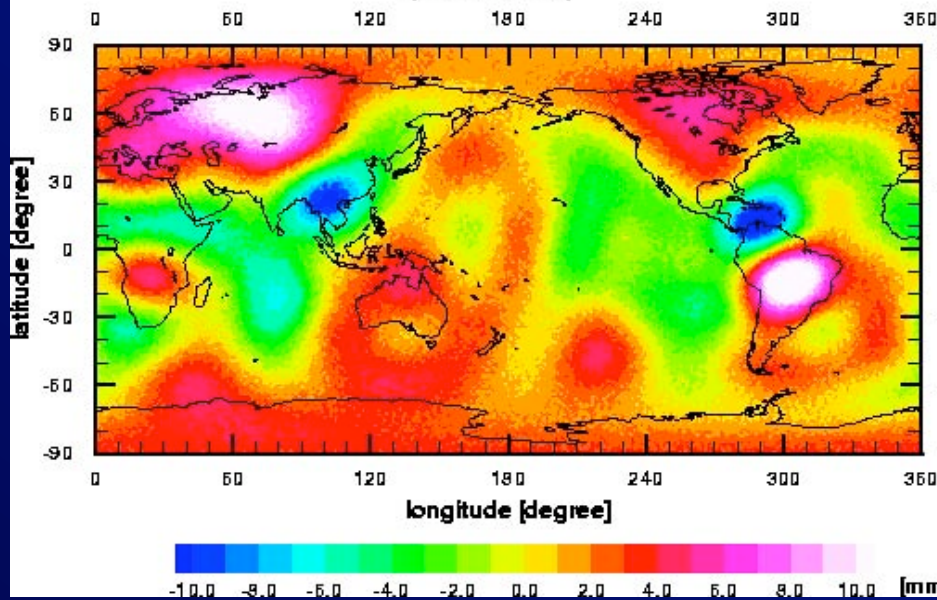

(hydro. signal correct. $n = m = 10$)

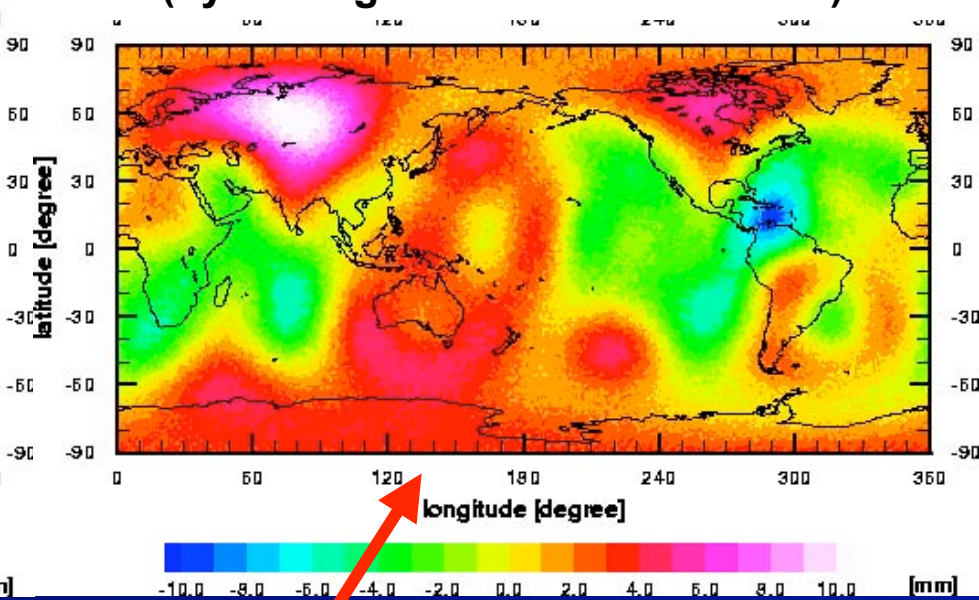

Gravity field coefficients up to degree and order 20 corrected by coefficients from hydrological model





Helmholtz Association GRACE related Funding

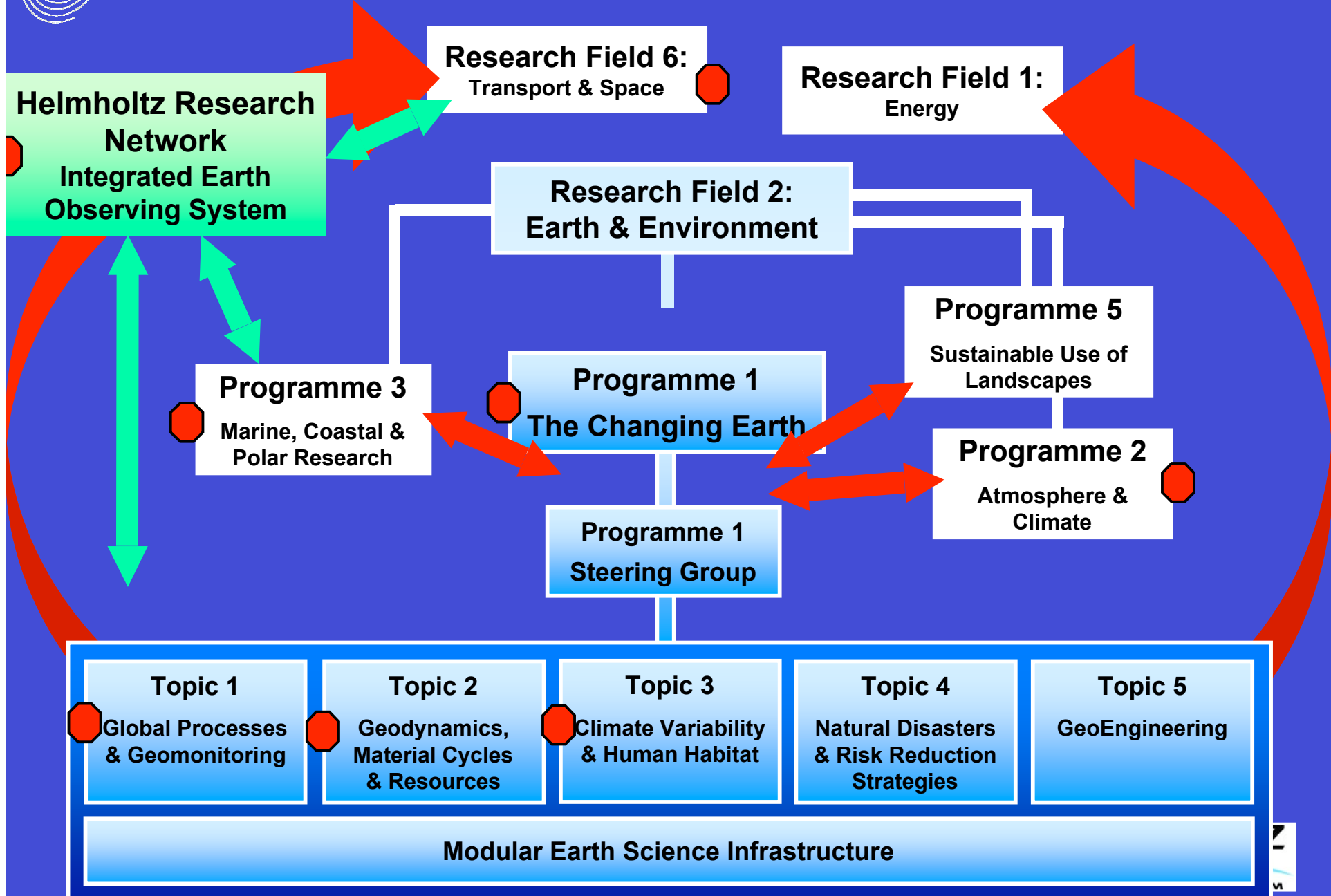



German Programs with GRACE related funding



Helmholtz Association Programme Oriented Funding (2004 – 2008):

– Geosystem: The Changing Earth

1. Global Processes and Geomonitoring
2. Geodynamics, Material Cycles and Natural Resources
3. Climate Variability and Human Habitat
4. Natural Disasters and Risk Reduction Strategies
5. Geoengineering

– Marine, Coastal and Polar Systems

1. MAR: Ocean and Global Climate
2. CO: Coastal Areas
3. POL: Polar Regions
4. I: Infrastructure





German Programs with GRACE related funding



Helmholtz Association Programme Oriented Funding (2004 – 2008):

–Atmosphere and Climate

1. Climate and hydrological cycle
2. Regional climate change and impact
3. Trance Substances in the Troposphere
4. Changes in the Tropopause Region
5. The Stratosphere in a Changing Environment





German Programs with GRACE related funding



**German Ministry for Education and Research (BMBF),
'Geotechnologien'-Program Topic 2 'Observing the System Earth
from Space' (first stage 2001 – 2004):**

**Development of a science processing system for GRACE
(GFZ Potsdam)**

including:

**Regional gravity field modeling
(Univ. Bonn)**

and

**Processor development for the analysis of time varying gravity field
(Univ. Stuttgart)**





German Programs with GRACE related funding



Parallel funding by German Research Foundation (DFG):

- **Determination of magnetic gravity field, ice mass balance and crustal structure in Antarctica from satellite, air-borne and ground-based measurements**
(Univ. Dresden, AWI Bremerhaven)
- **Dynamics and ice mass budget in coastal areas of Antarctica**
(Univ. Münster, Univ. Dresden)
- **The Fennoscandian land uplift: a test and application area for GRACE**
(Univ. Hannover)
- **Time variability of the global gravity field due to mantle flow: detection by the satellite mission GRACE**
(Univ. Frankfurt/M.)
- **Oceanographic model data for the interpretation and correction of satellite data**
(Univ. Hamburg, Univ. Dresden)





German Projects with GRACE related funding



German Priority Research Program 'Mass Transports & Mass Distribution in the Earth System'

in preparation for submission to German Research Foundation (DFG):

Mass transports and mass distribution in the Earth system: contributions of the new generation of satellite gravity and altimeter missions to the geosciences

(Coordinators: GFZ Potsdam, Univ. München, Univ. Bonn, Univ. Frankfurt, Univ. Kaiserslautern, Univ. Dresden, Univ. Stuttgart, DGF München, AWI Bremerhaven)

German Priority Research Program 'Quantitative Precipitation Forecast' (DFG) Submitted Proposal

- Atmospheric sounding by GPS radio occultation: Improving the precipitation forecasts
(GFZ Potsdam, German Weather Service (DWD), Univ. Leipzig)





Results obtained sofar for CHAMP allow to expect that predicted GRACE performance will be achievable (it only needs time, brain, energy and money)



Error Reduction for High Resolution Gravity Field Models by Inclusion of Gravity Field Missions in Sequence of their Launches

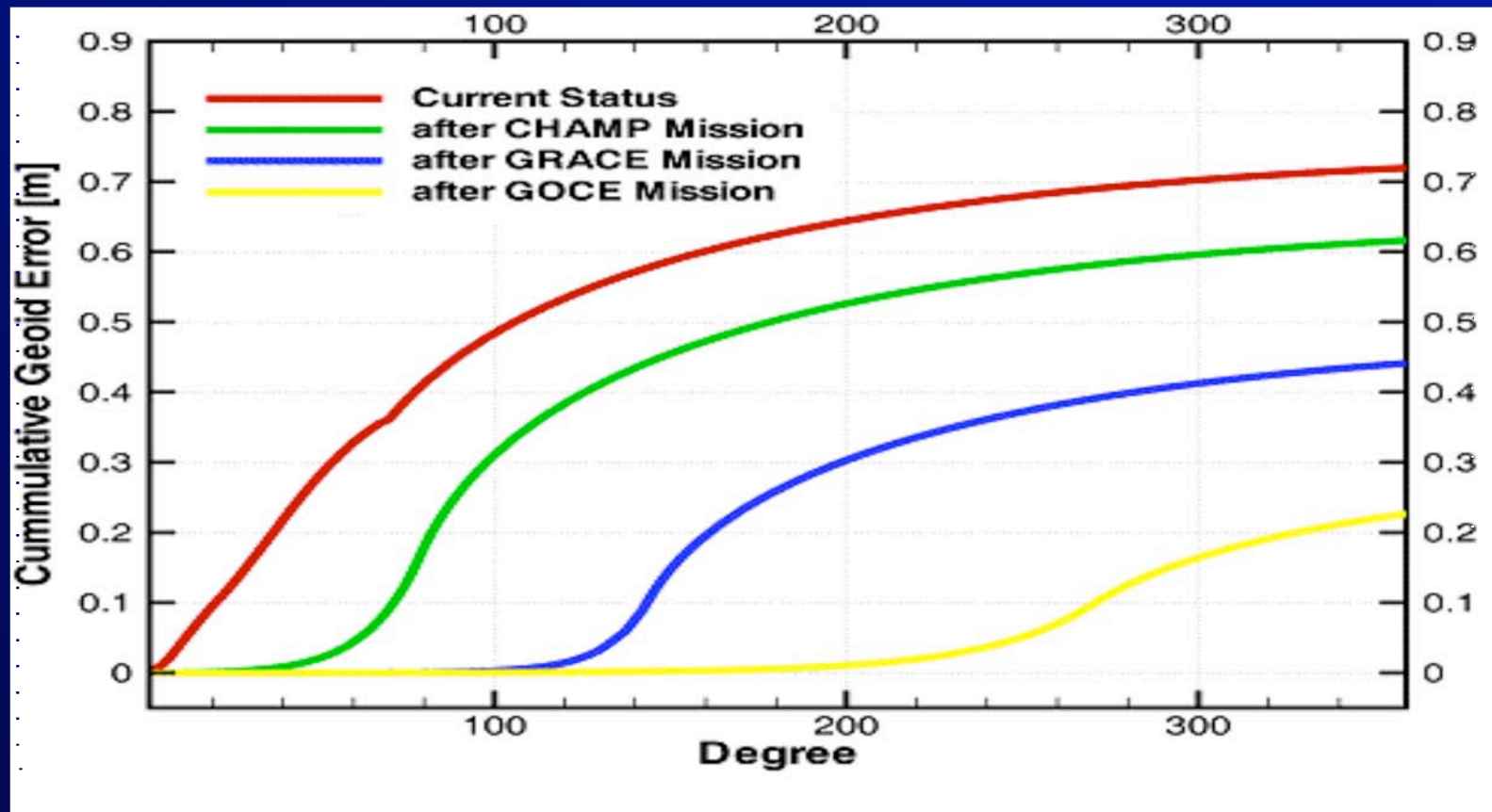



GRACE Flight Segment

JPL
Jet Propulsion Laboratory
California Institute of Technology

GRACE Mission Flight Segment

**Ab Davis
8 October 2003**



GRACE Flight Segment Agenda

- **System Performance**
 - Overview
 - Attitude Control
 - Structural Stability
- **Lifetime Prognosis**
 - Thruster Actuation
 - Fuel Consumption
 - Power System
 - Altitude
 - ATOX Risk
 - Single-Point Failures



GRACE Flight Segment System Performance - Overview



- **K-band and GPS performance is excellent**
 - Except USO-004 on Grace-2 - backup USO on Grace-2 is OK
- **ACC performance is meeting expectations**
 - Thermal control of GR1 ICU is bias toward maximizing Life
- **Thermal Control is excellent and Structure is stable**
 - Living with ~ 100 TWANGS / orbit
- **AOCS functioning well in all modes**
 - Thrusters are responding to Star camera transients
 - Magnetic control algorithms have room for improvement
- **Enhanced Star Camera Performance is in process**
 - Both cameras operating at 1-Hz rate - Need to reduce transients
- **Cold-Gas and Mass Trim Systems: working well**
- **Flight Computer and Power System: working well**
- **Vulnerability to Single-Point-Failures is stable**



GRACE Flight Segment Attitude Control

- **Attitude Control: not quite meeting .5 mr control**
 - Cold Gas thrusters (10 mn) - YAW and ROLL aligned to the orbit normal
 - Mag-torquers (30 amp-m²) - Almost 100% effective in controlling PITCH
- **Attitude Knowledge: not always good to 0.1 mr**
 - Errors of 0.5 mr suspected in part of the orbit
- **Thruster Actuation rate is higher than desired.**
- **WORK IN PROCESS ON:**
 - Star Camera SW - Plan to optimize by Dec 2003
 - Magnetic Control Laws - Plan to revise by Apr 2004



GRACE Flight Segment Thermal & Structural Stability



- "Twangs" are frequently recorded by the SuperStar Accelerometer
- Most likely source is the thermal radiator film on the Nadir side of the satellites
- Our "Model" fits the observed character of the twangs

Figures - From UTCSR:

Top - 20,000 nm/s² example

Bottom - Histogram of Oscillation
Freq. (1 week Dec 2003)

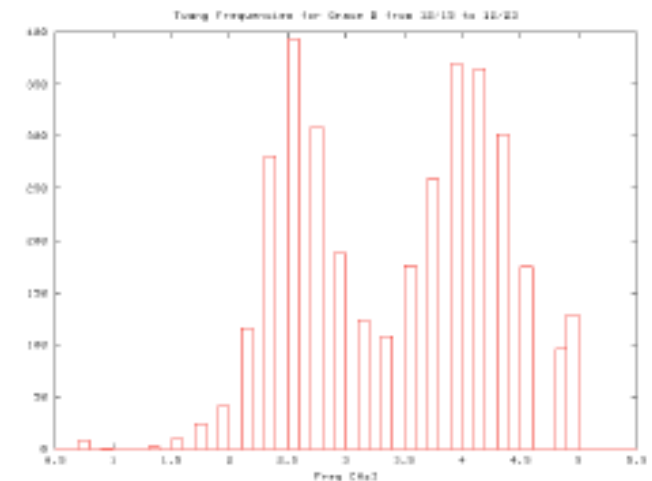
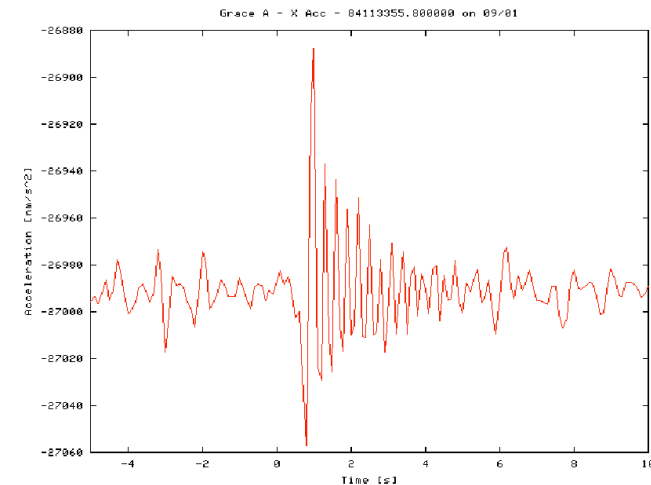



GRACE Flight Segment Twang Model

Damped Harmonic Oscillator

$$X=A \cdot \sin(2\pi f)$$

Mass_1 = ?

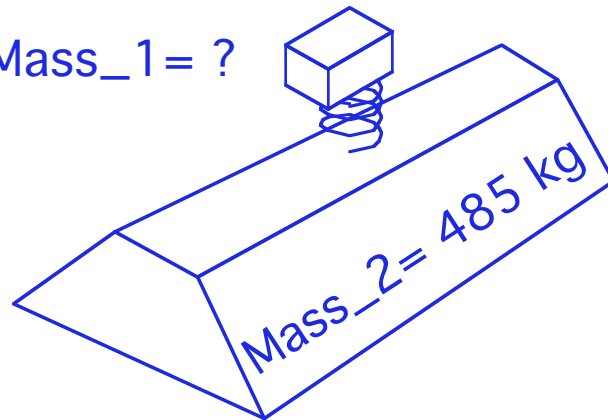

Nadir Radiator Panel

- Teflon foil 0.1 to 0.15 mm thick
- 5x5 cm section weighs ~1 gm
- Attached to posts by snap rings at 20 °C
- Post spacing varies
 - Approximately 10 cm

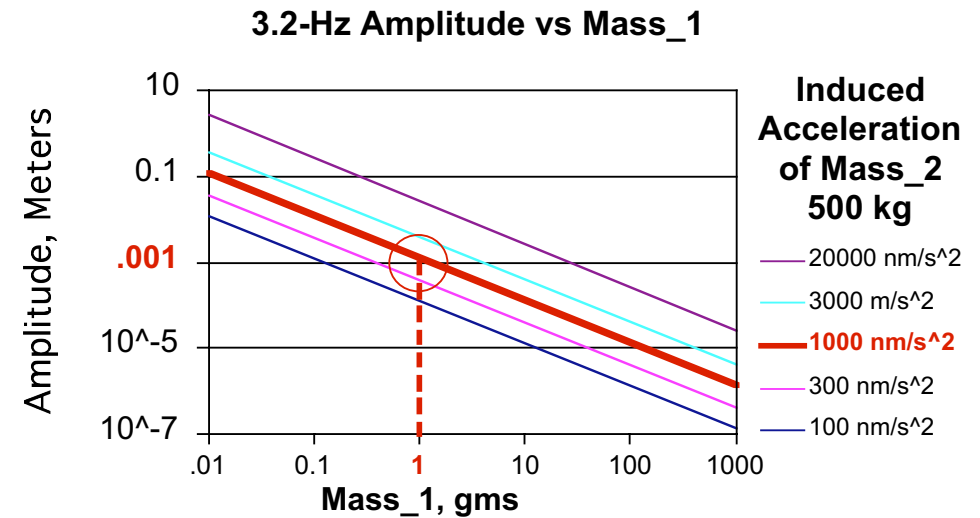



GRACE Flight Segment Twangs - Conclusion

- **The frequency is above the gravity signal bandwidth**
 - Upper limit ~ 0.05 Hz
- **Preliminary analysis at UTCSR suggests that the net impact of a single twang on the observed non-gravitational force on a GRACE Satellite is negligible**
 - i.e. the instrumentation doesn't distort the effect and thereby introduce an error - **To Be Confirmed**
- **No options for mitigation in the flight segment**
 - Only options for mitigation are in Level-1 or Level-2 processing



GRACE Flight Segment Lifetime Constraints

- **Cold Gas: > 32 kg**
 - On GR1: ~ 26 kg remaining
 - On GR2: ~ 29 kg remaining
- **Thruster Actuations: - 1,000,000 to 2,000,000**
- **Battery Discharge Cycles: 50,000 to 100,000**
- **Altitude: ~ 1 year left at 400 to 425 km**



GRACE Flight Segment Life Expectancy - Cold-Gas

- **GRACE-1 has the least remaining life**
 - Greater than 10 yrs based on fuel consumption
 - 8 to 10 years based on soft estimate of maximum # of thruster actuations

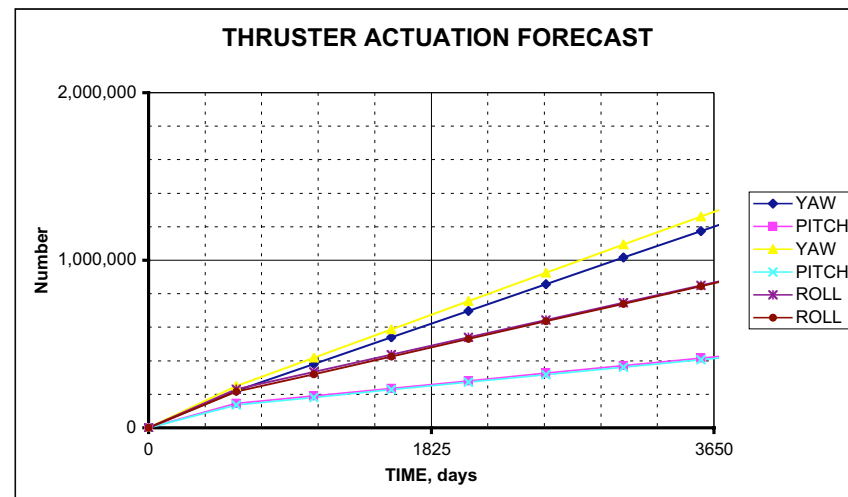
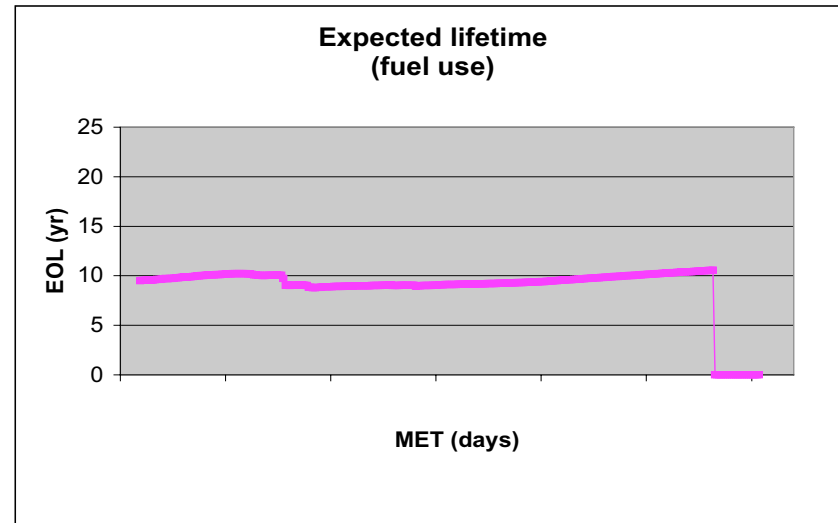



GRACE Flight Segment Power System



- **Battery Lifetime Determinants:**
 - Depth of Discharge (DOD), and Battery Temperature
- **Assessment:**
 - Max. DOD in GR 2: ~31 %; GR1 even lower
 - For a DOD of 60 % Life= 30,000 cycles (~5 yrs),
For a DOD of 20 % Life= 100,000 cycles ~17 yrs)
- **Batteries are good for over 10 years**

- **Margin on GR2 is 15 Watts better than estimated at the Pre-ship Review**
 - GR1 margin even is higher
 - The systems on both satellites have flexibility to cope with single failures - No Degradation

C. Belle, Astrium



GRACE Flight Segment Orbit Altitude Decay

- Orbit decay suggests an 8- to 10-yr mission life
- All but the last year is above 400 to 425 km altitude

D. Maznek, NASA LaRC

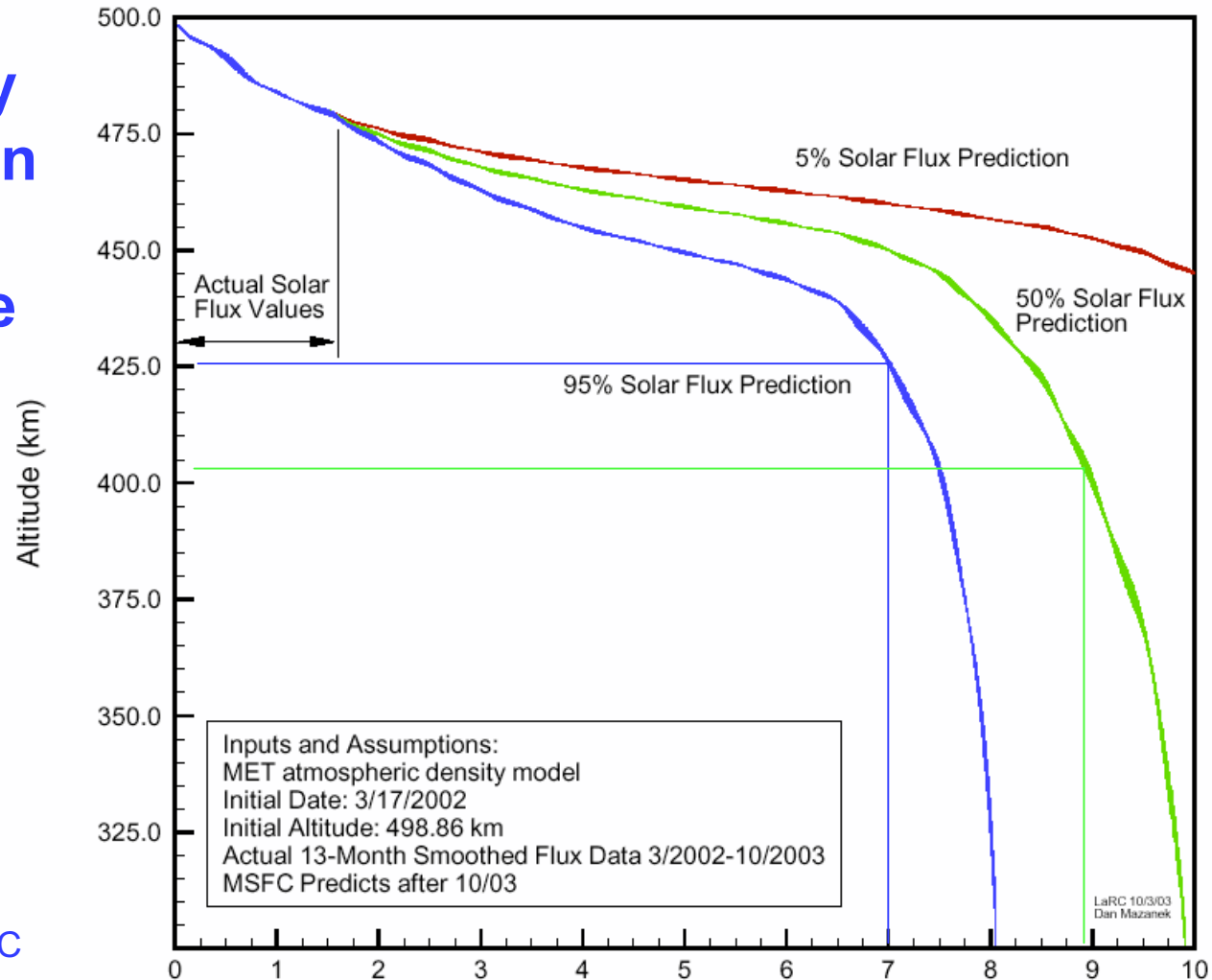



GRACE Flight Segment Thermal Control of the K-Band Horn

JPL
Jet Propulsion Laboratory
California Institute of Technology



- **Horn aperture is 11 cm. in diameter**
- **Silicon-Oxide-Coated Kapton Foil**
 - Kapton foil is .025 mm thick
- **Backed by Low-Density Kapton Foam**
 - The backing plug is approximately 5 cm thick



GRACE Flight Segment Estimates of the ATOX Environment

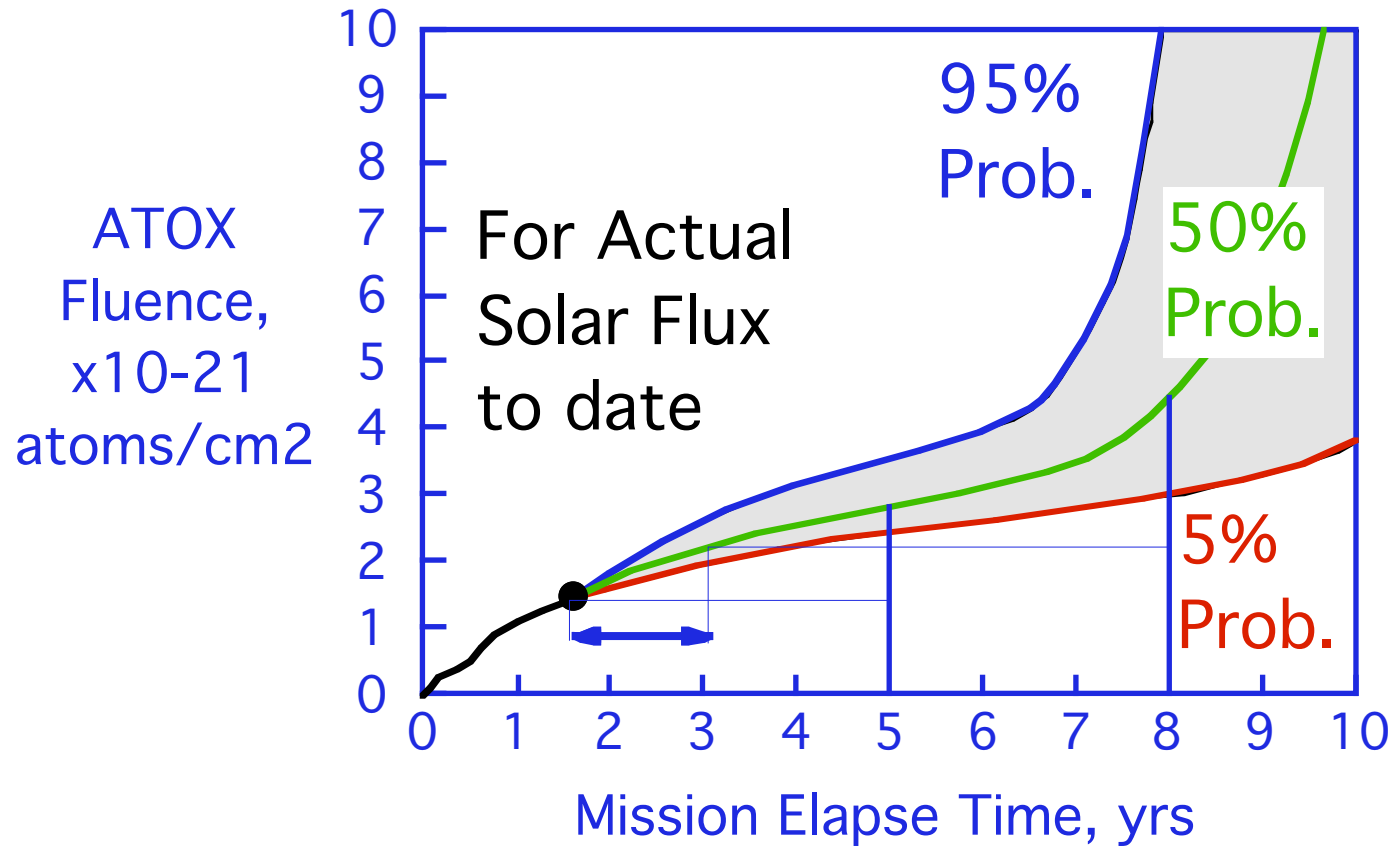

D. Mazanek, NASA LaRC



GRACE Flight Segment Mitigating the ATOX Risk

- **The Mission Plan**
 - One-time event to switch the leading and trailing satellites
 - At approximately 1/2 way through the mission
 - As measured by the ATOX load on the material on the front of the trailing satellite.
- **Event should be scheduled between NOW and March 2005**



GRACE Flight Segment Vulnerability to Single-Point Failures



- **Stable since 23 May 2002**

SPF's GRACE-1

Minimum Mission "Can't fails"

Baseline Mission "Can't fails"

- USO-redundant
- MWA-redundant
- ACC Sensor Unit
- ACC ICU redundant

Needed for a Rate Emergency

- Flux-gate magnetometer

Needed for Simple Operations

- Both Star Cameras

SPF's GRACE-2

- ACC Sensor Unit



GRACE Flight Segment Bottom Line

- **Performance of the flight segment is satisfactory**
- **It will get better in the coming months!**
 - Reduce disturbance to the observables from attitude control
- **The life expectancy is approximately 10 years**
 - The highest risk of a single-point failure is on GR1.
 - K-Band performance is most threatened on GR2
 - ATOX degradation of the thermal control system.



GRACE Mission
Science Team Meeting



Ground Segment & Operations

8 October 2003

**Joe Beerer
Operations Mission Manager**



GRACE Mission

Agenda



- **Ground operations facilities**
- **Description of routine operations**
- **Timeline for planning special events**



GRACE Mission

German Space Operations



GSOC

Neustrelitz GS &
Raw Data Center



Control Center
Oberpfaffenhofen

Weilheim
Ground Station





4 daily passes per satellite at German stations

- two A.M. passes (NST & WHM)
- two P.M. passes (NST & WHM)

Telemetry at all passes

- Real time SCI & HK data*
- MMU data dumps

Commanding at WHM passes

- Time-tagged commands loaded for transmitter on/off & for dump activities
- Two-line elements (TLEs) uploaded daily

* *Real time data received at NST replayed at GSOC about 30 min. after pass*



GRACE Mission

Polar Ground Network (PGN)



The NASA PGN provides added GRACE coverage

- ***One pass per business day in GSOC's prime shift
- additional monitoring for GRACE-1***
- ***Specially scheduled passes for software uploads***

Tracking stations at:

- ***Svalbard, Spitzbergen Island (Norway)***
- ***Poker Flat, Alaska***
- ***McMurdo, Antarctica***
- ***Wallops Island, Virginia***



Star Camera Ops - 1

"Prime" camera used for AOCS and science

"Secondary" camera used for science only

- **Prime camera selected to be on side of satellite away from the Sun**
- **Secondary camera is generally blinded part of each orbit**
- **Operators command a change of prime camera when sun beta-prime angle passes through 0 deg (every 160 days)**



Star Camera Ops - 2

Moon intrusion in primary star camera

- Prevents prime camera from providing valid quaternions
- Occurs twice per month for ~ 2-day period
- "Head swapping" commands uploaded in advance
 - Switch to other camera during part of each orbit to obtain valid quaternions
- "Head swapping" not an option when Sun is in the secondary camera simultaneously
 - In these cases, the satellites "coast" through the intrusion period - added propellant expenditure



GRACE Mission



Star Camera Ops - 3

Plan to monitor for camera head degradation

- **Will take uncompressed star images in eclipse at each beta=0 crossing, using the secondary camera**
- **Will note the number of "hot pixels"**
- **Next crossing is December 2003**



-
- **Battery end-of-charge (EOC) level must be managed to accommodate varying eclipse duration**
 - **EOC level changes are uplinked periodically**
 - **Must provide adequate power at end of eclipse period while maintaining the battery at lowest possible temperature - conserves battery life**

 - **To keep battery temp within limits, twice last winter, setpoints on 9 heaters were reduced (1 deg & 2 deg C)**
 - **ACC thermal cage (-z, +z)**
 - **CFRP Frame at I/F to baseplate**
 - **harness to ACC sensor**



GRACE Mission

Power - 2



Coarse pointing mode (safe mode) requires yaw steering when sun beta angle > 30 deg

- Upload "kyaw flag=1" just before angle exceeds 30 deg
- Upload "kyaw flag=0" just before angle drops below 30 deg



Procedures now in place to ensure interruption-free data

- **Lifetime considerations dictate a thermal control strategy for the ICU**
 - **ICU heater setpoints: 19C GR-1 and 20C GR-2**
 - **Stable ICU temp maintained except during "full sun" periods**
- **Monthly check of the ICU heater duty cycle**
 - **High-rate telemetry for the heater power received for several hours**

ICU = Instrument Control Unit



ICU has entered non-nominal state several times

- Traps are in place to catch this condition
 - GDEL flag and Vp monitoring
- SDS is implementing "quick look" comparison of ACC measurements of two satellites
- Response is to command an ICU power cycle
 - This has cleared the ICU except for one instance (5/21/03)



GRACE Mission



KBR

Procedures now in place to ensure interruption-free data

- **Only planned interruptions are those orbit trim maneuvers that require satellite reorientation**



Orbit Maintenance

Separation distance between the satellites is maintained at 170 - 270 km

- **Orbit trim maneuvers are scheduled as needed - always on GRACE-2 - has more propellant**
- **Last maneuver was on 30-Jan 2003**
- **Current separation distance is 216 km**
- **Current drift rate is near zero**
- **Next maneuver projected to be in spring 2004**



Satellite center of mass (CoM) must be maintained within 100 microns of the ACC proof mass

- **CoM "trims" are performed as necessary**
 - **Last trim: GR-1, 7-Mar 2003; GR-2, 6-May 2002**
- **SDS analytically tracks the CoM**
- **Periodic CoM "calibrations" are required to verify the SDS analytic results**
 - **Last cal: GR-1, 7-Mar 2003; GR-2, 27-Feb 2003**
 - **Next cal: within the next 2-3 months**



Special Event Planning

A 2-3 week planning cycle is required for special activities on the satellites

- The following slide shows a timeline for the planning of the near-simultaneous CoM-cals that were performed in Feb 2003
- Purpose of this activity was to evaluate the relative bias and scale of ACC measurements between the two GRACE satellites
- Desired that CoM-cals be nearly at the same time only separated by ~25 seconds, which is the time it takes for GRACE-2 to travel to GRACE-1's position



-
- | | | |
|--------|---------|---|
| 10-Feb | e-mail | Gerard (JPL) issues proposal for dual cals |
| 11-Feb | e-mail | Jaap (GSOC) provides assessment of work required |
| 13-Feb | telecon | Discuss approach, Jaap to write Recommendation
Put cals on Ops calendar for week of 24-Feb |
| 18-Feb | telecon | Discuss detailed timing of cals |
| 20-Feb | telecon | Schedule cals for 26-Feb |
| 21-Feb | e-mail | Jaap issues preliminary Recommendation for review |
| 24-Feb | telecon | Decision that Real Time Testbed test is not required
Reschedule cals for 27-Feb |
| 25-Feb | e-mail | Jaap issues final Recommendation |
| 27-Feb | | Cals executed on satellites |

Note: Ops telecons are now held once per week (Tuesday). Last February telecons were held twice per week

Orbit Elements - SemiMajor Axis

500 km injection was selected to optimize time-variability monitoring

The altitude will be allowed to decay naturally

Very low-altitude data will be available only late in the mission

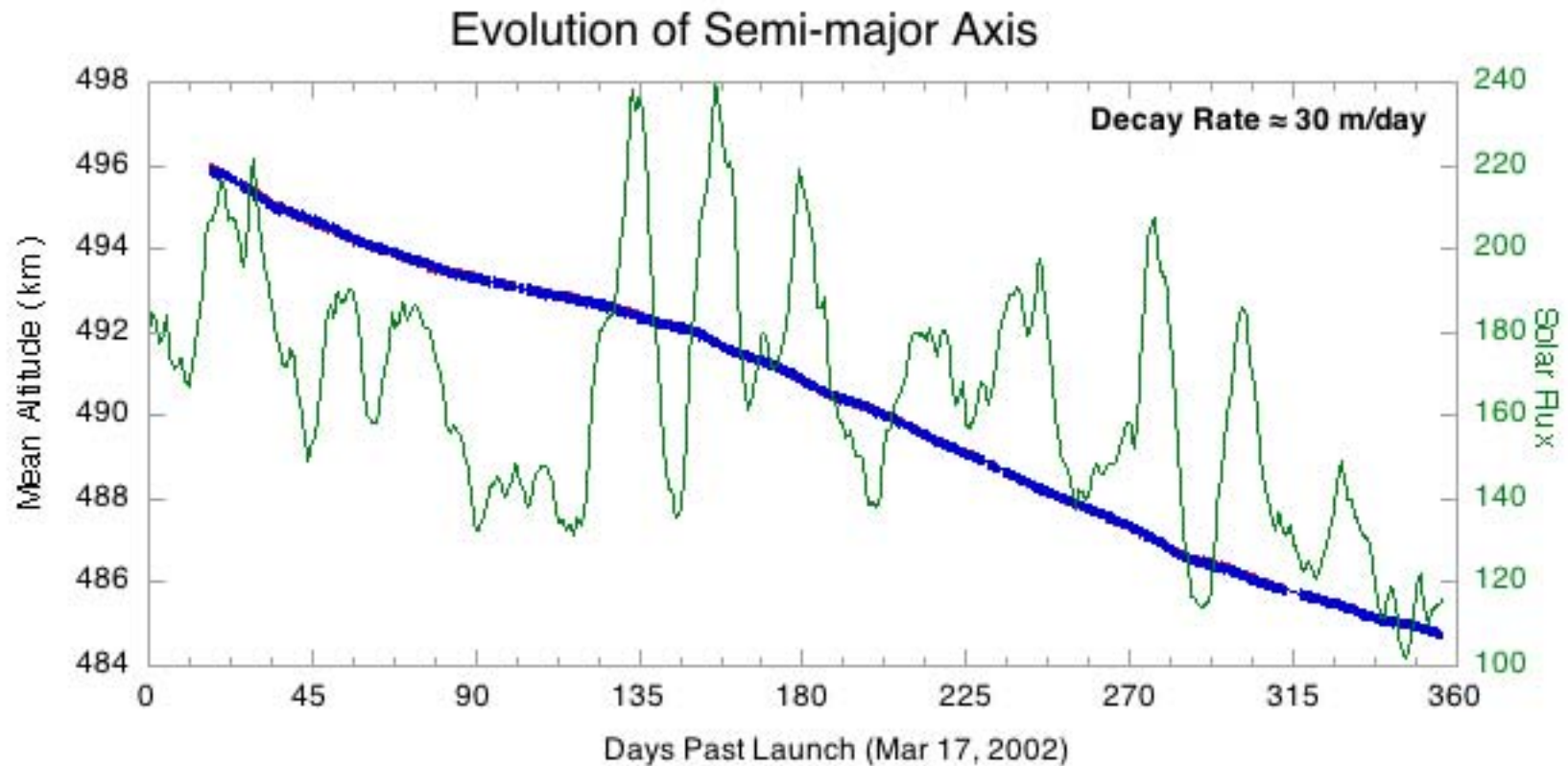

Orbit Elements - Eccentricity

Mean eccentricity difference has an effect on peak range signal
Routine station-keeping maneuvers will attempt to reduce difference
(no special effort is being made to circularize or equalize)

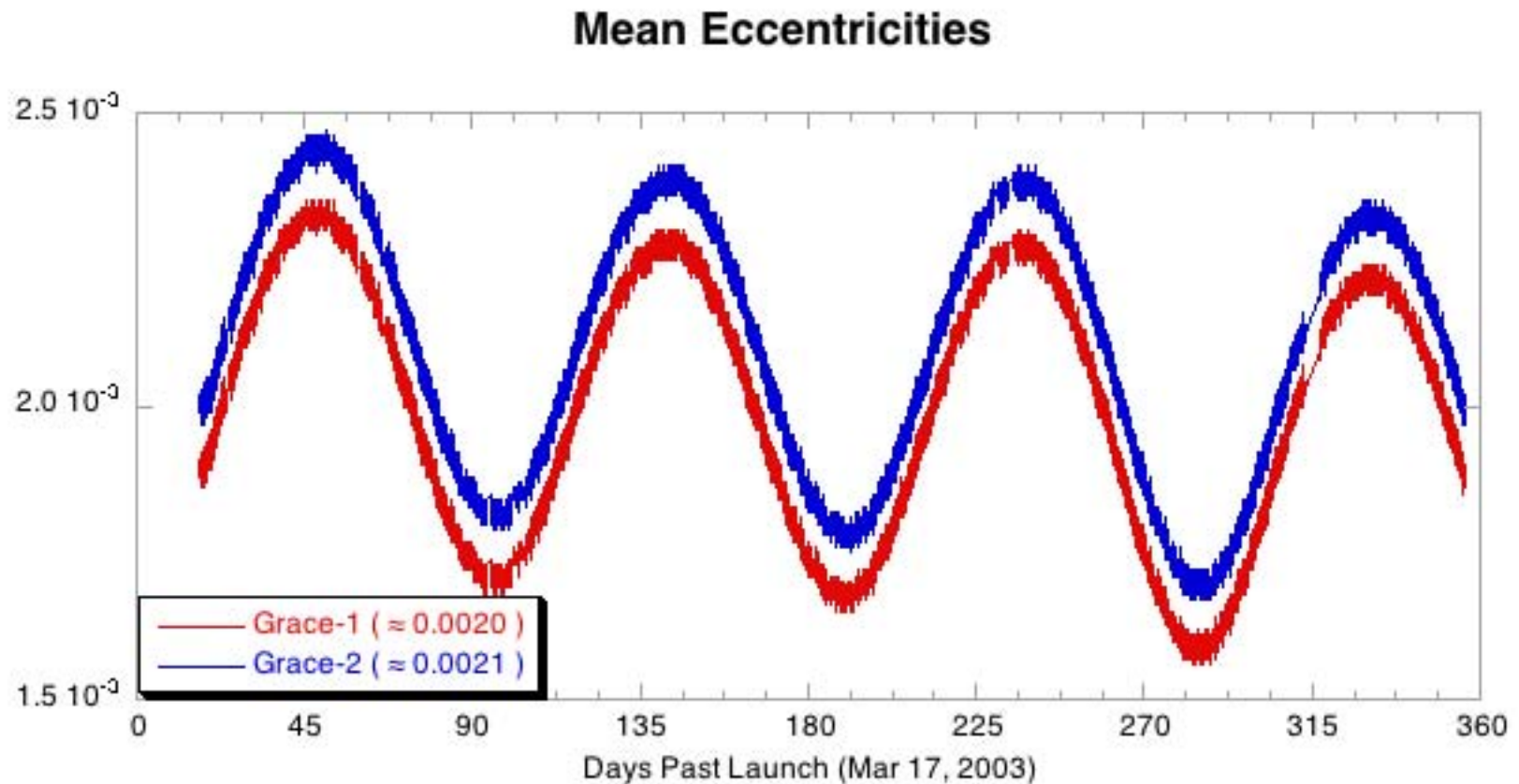

Station Keeping

General approach is to maximize time between maneuvers (range 170 km to 270 km)
Make-up maneuvers are preferentially done on Grace-2 (heavier, trailing satellite)

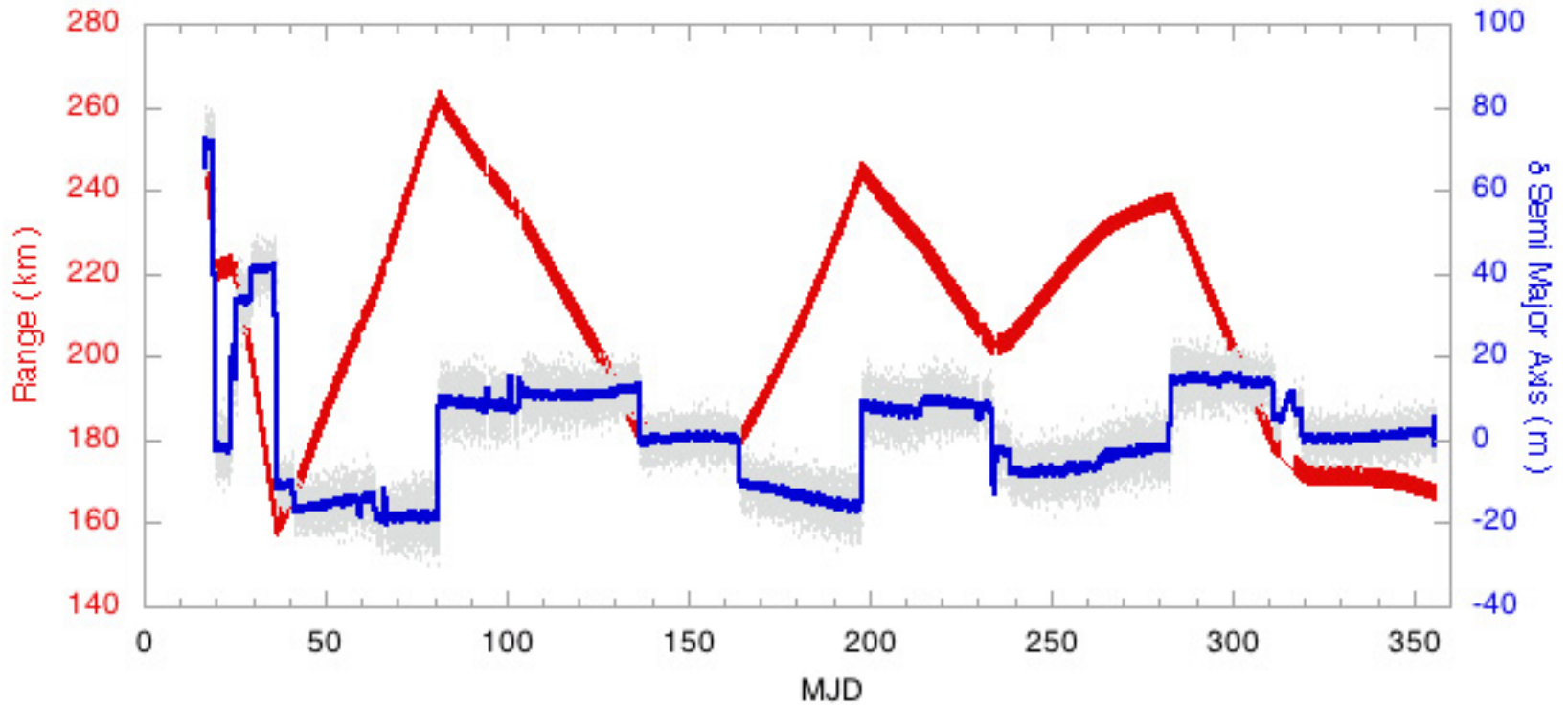

Evolution of Signal Amplitude

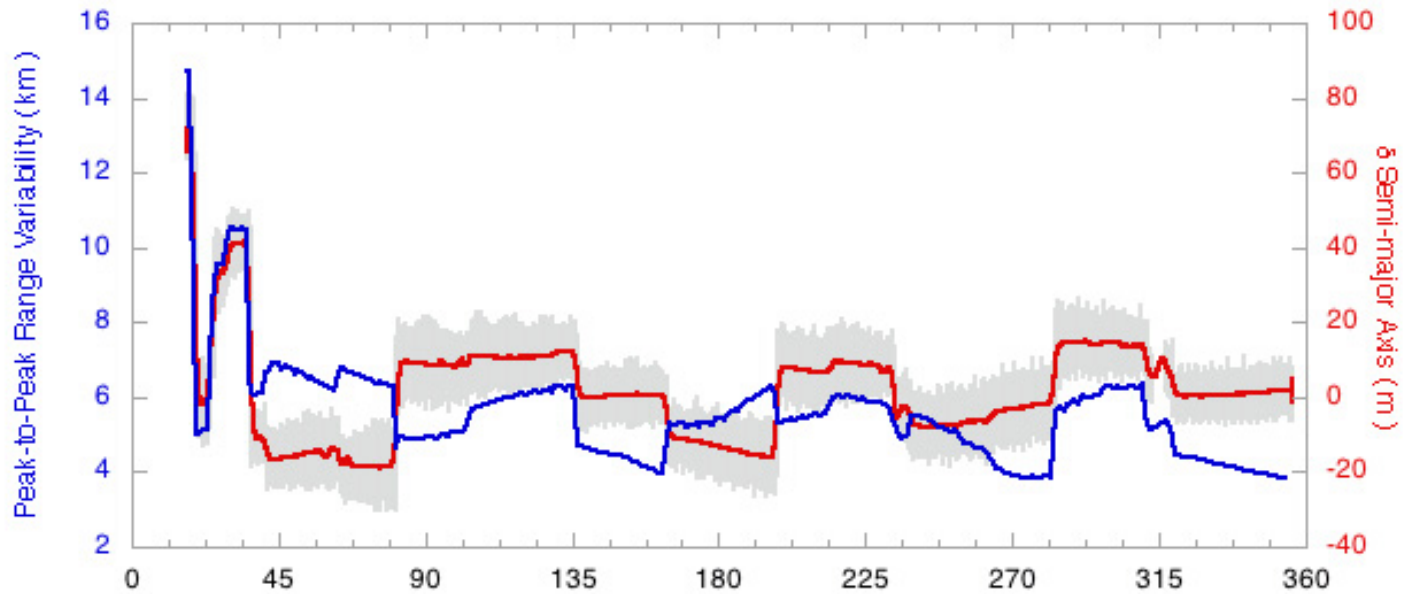

Peak-to-Peak Signal Amplitude depends on

- Semi-major axis differences
- Eccentricity variations
- odd-zonal (J_3 ...) perturbations, and so on...

Station Keeping : Current Status

Relative Motion of both GRACE Satellites

Maneuver Planning -- cycle after 6th OMM -- estimated cd-values -- MN=32 -- CMCPM G2

Initial epoch: 2003/06/27 00:00:00.0

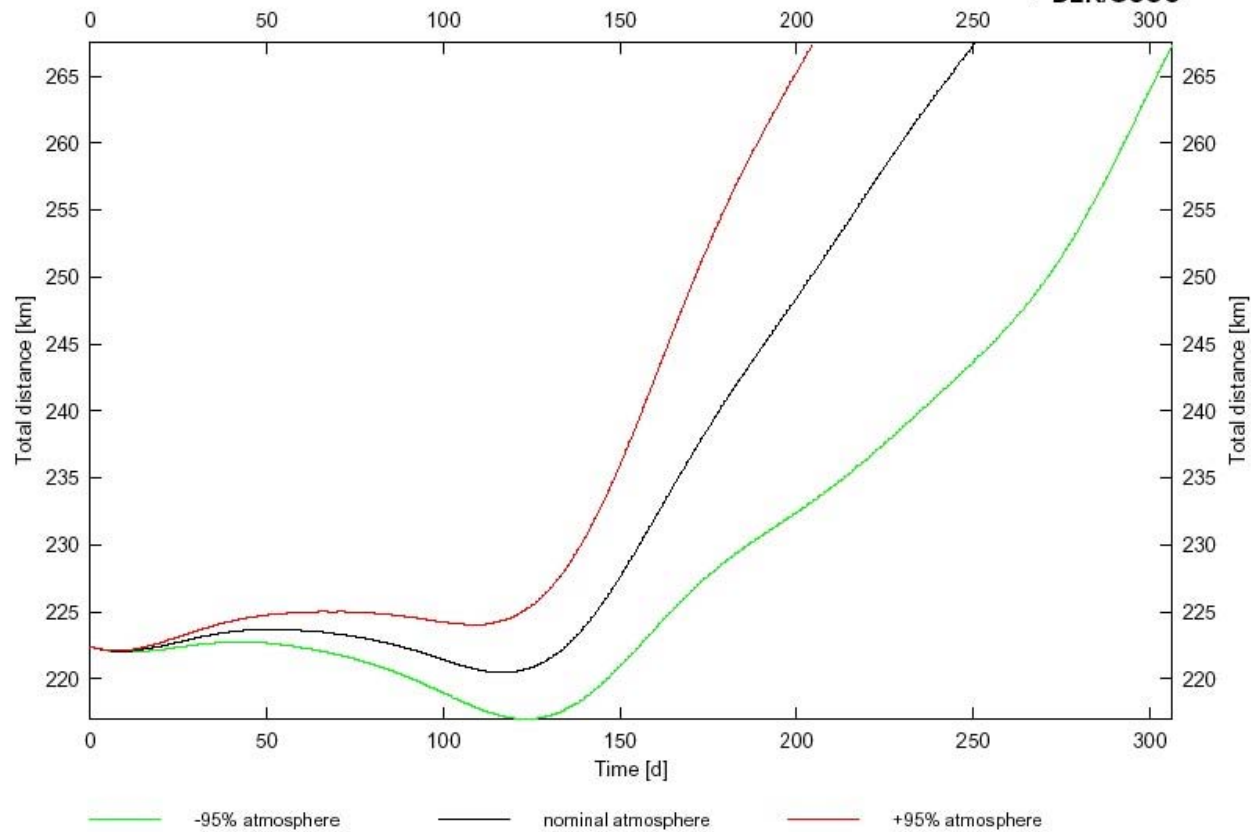

(mk/gsoc)

Gravity Field Solution Interval

- Gravity Field solutions are generated at approximately monthly intervals
 - Uniformity or repeatability of ground track coverage is not assured between different solution spans - ground track is not controlled
 - Three examples on next few pages
 - On-board events & data sufficiency also dictate the span of solution
 - Solutions generally are not made over contiguous data spans, which would affect how the gravity fields are interpreted
 - Significant epochs noted later
-

Ground Track: Longitudes of Ascending Equator Crossings

August 2002

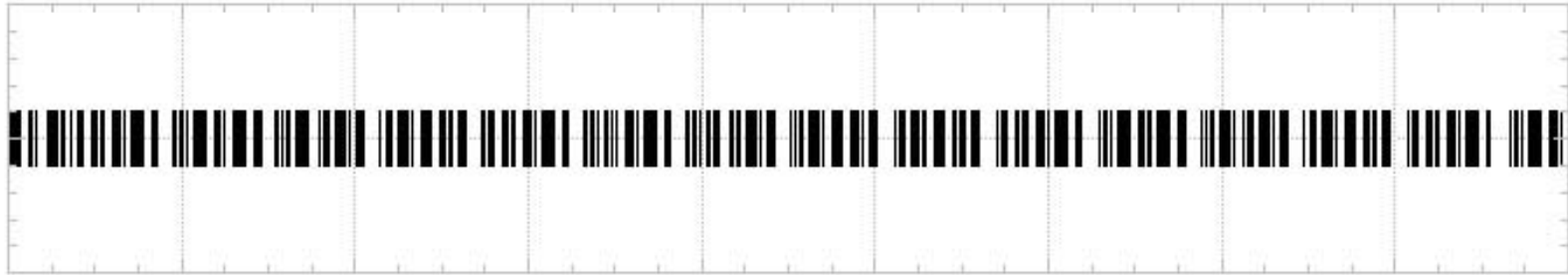

April 2003

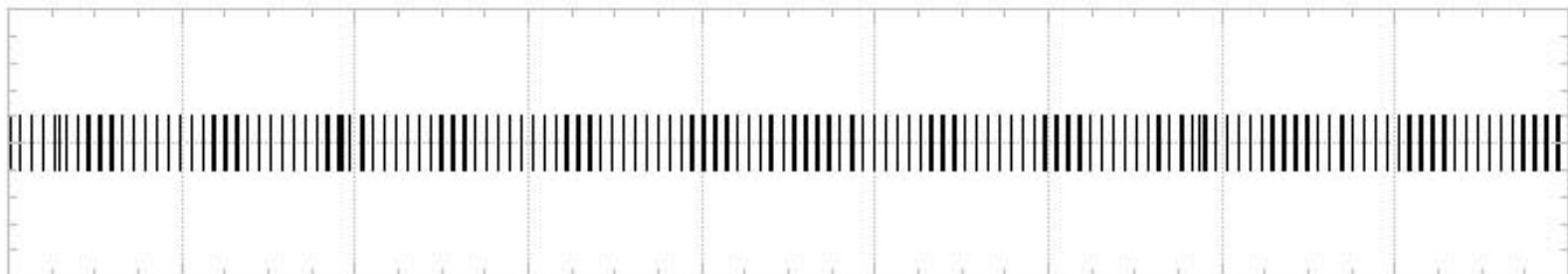

November 2002

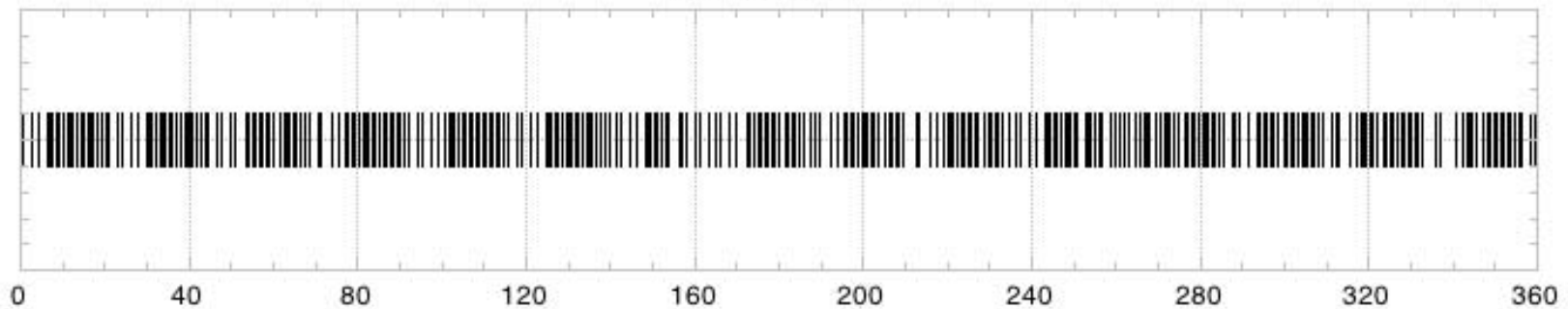

0 40 80 120 160 200 240 280 320 360

Ground Track Layout (S. America)

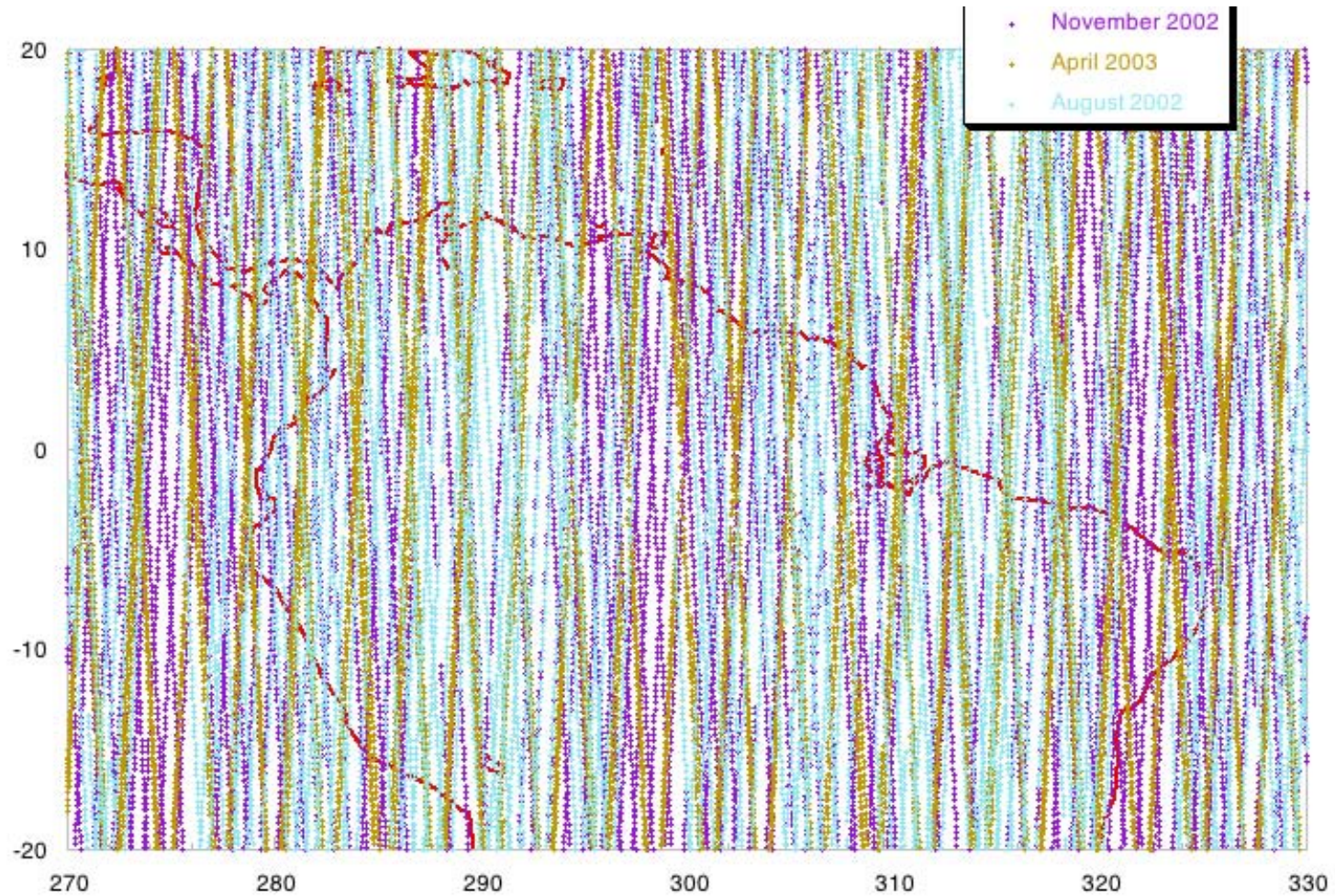

Ground Track Layout (Antarctica)

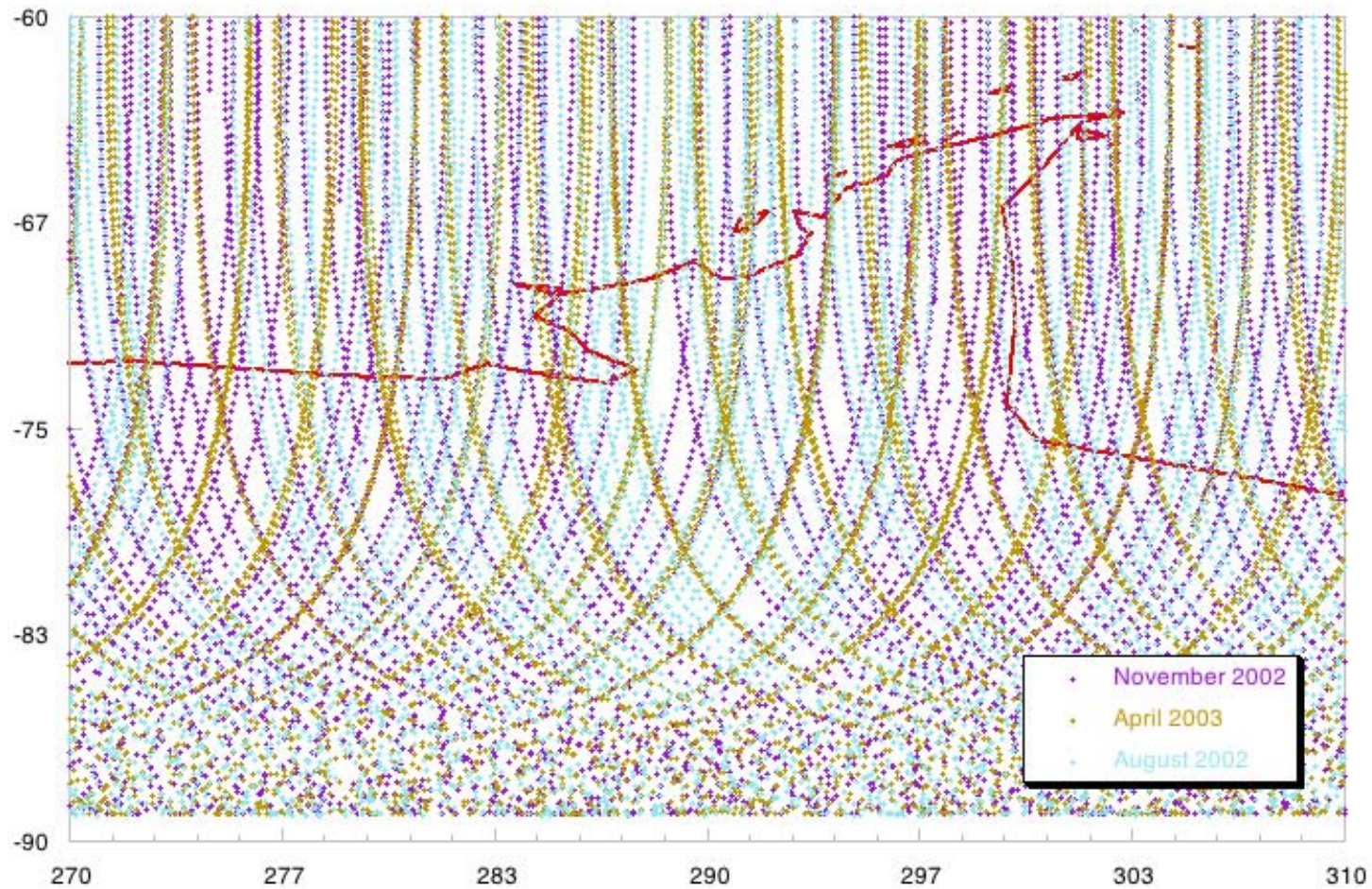

Evolution of Coverage

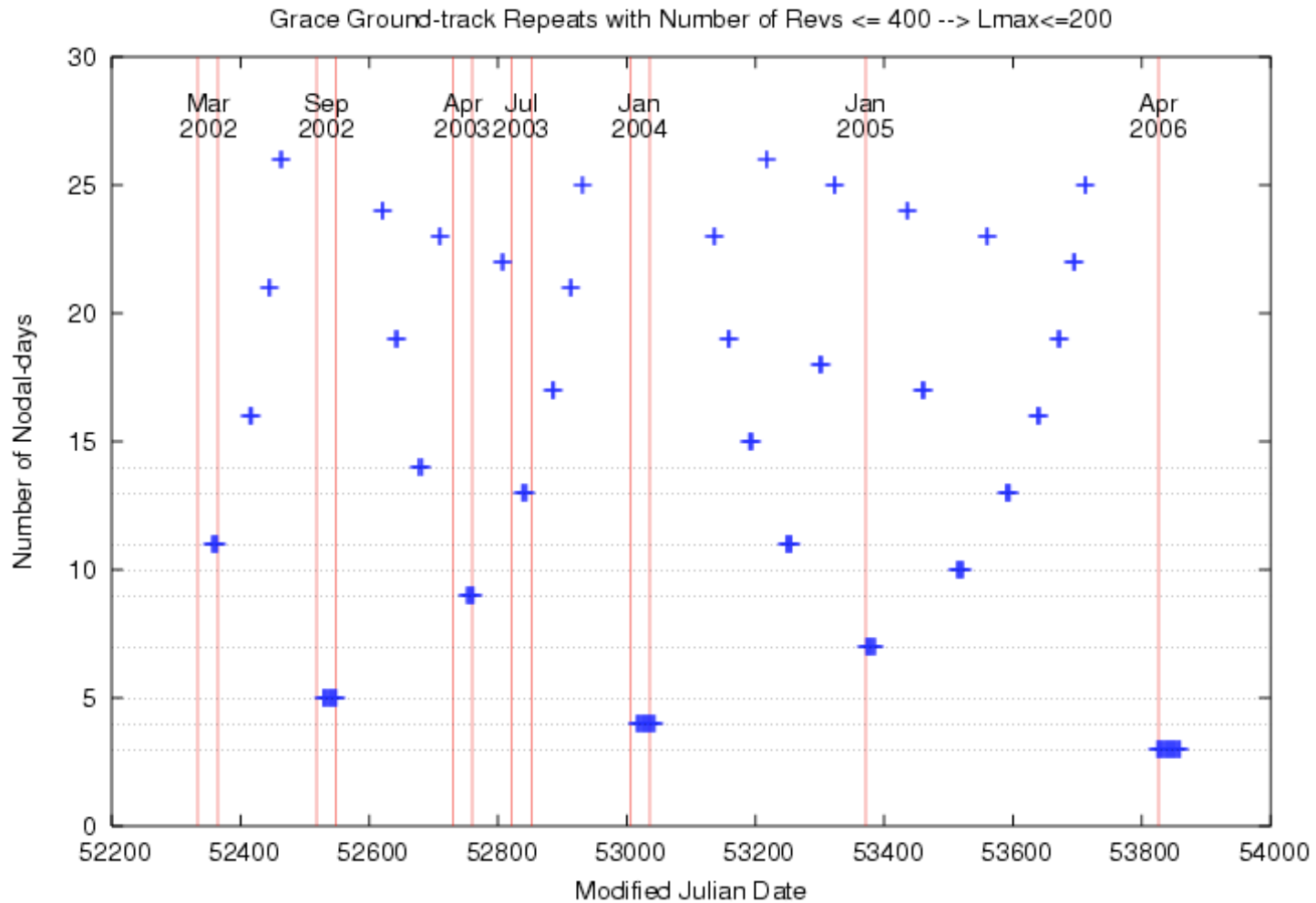

Significant Events Timeline

- 2002 - May 19 to Jul 23
 - Gravity field not estimated yet due to the absence of Grace-2 accelerometer data (all other data is available)
 - 2002 - Sep & Oct
 - Short (5-day) repeat cycle persisted for nearly 2 months
 - Effective resolution of solution is limited
 - 2002 Dec to 2003 (early) Feb
 - Data interruptions due to planned flight system configuration activities
 - Contiguous days in gravity solution are not assured
 - *Mission product quality is better after Feb 2003 as a result of these activities*
 - 2003 - May 21 to Jun 26
 - Possible gravity product gap due to Grace-2 Accelerometer data quality degradation
-

GRACE

Science Data System Overview

Michael Watkins

Project Scientist and Science Data System Manager

8 October 2003

GRACE SDS Tasks

- Process all gravity science data (for minimum and baseline science mission)
- Level 1 data processed within 12 days of collection
- Level 2 data processed within 60 days of acquisition
- Archive all science data
- Make all required measurement corrections available
- Initial and periodic verification of science data and products

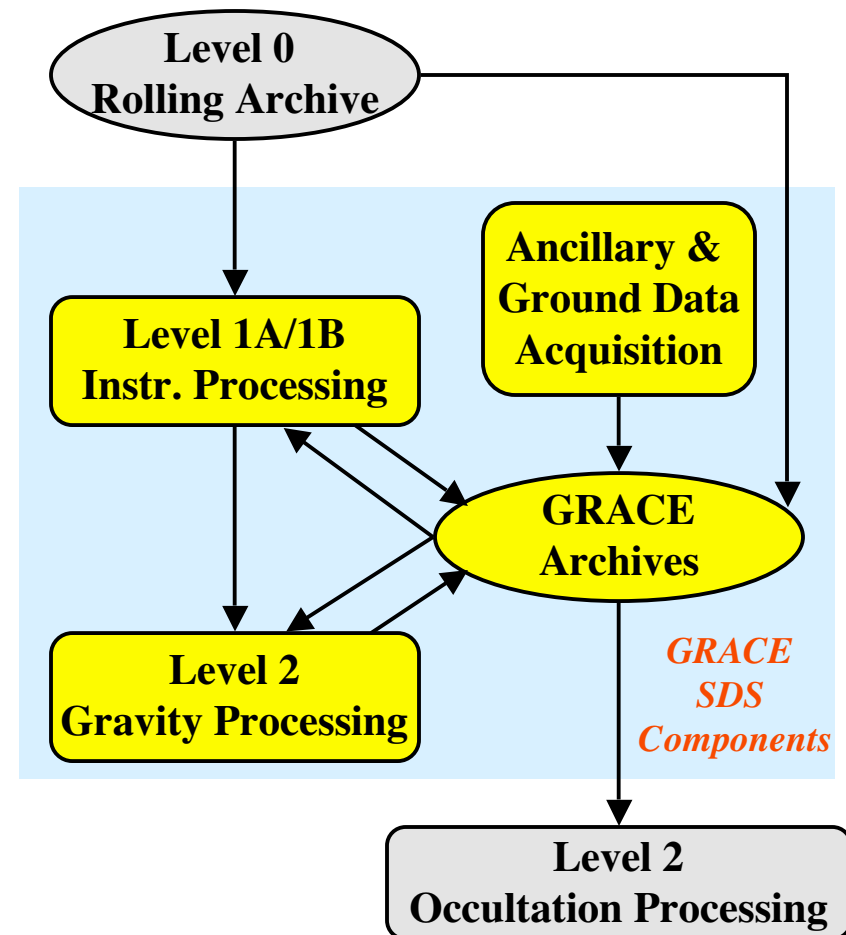

Responsibilities within SDS

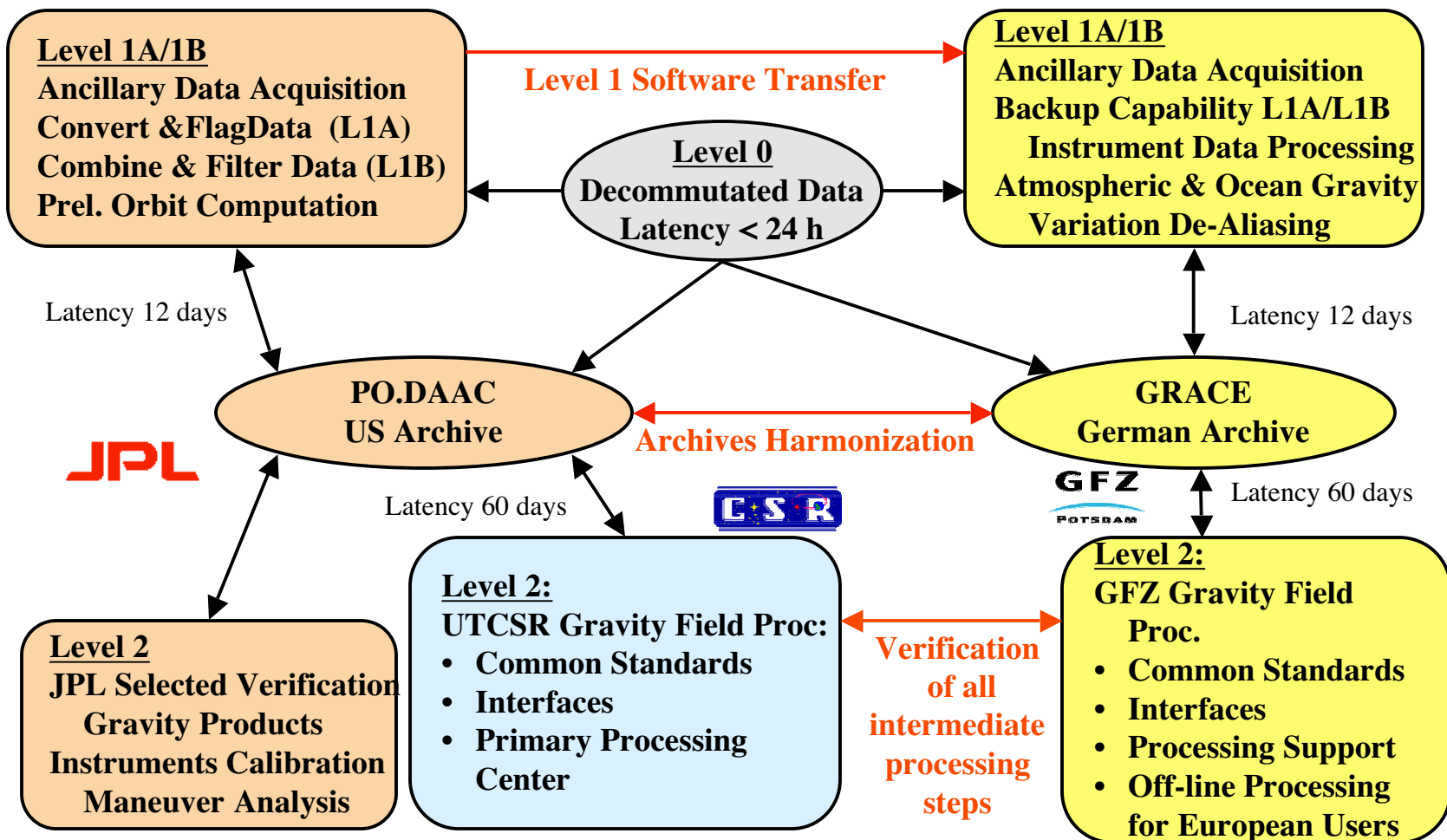

Basic Outline of Responsibilities

- Level 0 downlink - GSOC
 - Level 1 Processing - JPL (mirror at GFZ)
 - Dealiasing product generation - GFZ
 - Level 2 Processing - CSR and GFZ
 - Level 2 Verification - JPL
 - Archives - JPL PO.DAAC and GFZ ISDC
-

SDS Operational Roles

- Quicklook instrument health monitoring
 - More complex than expected prelaunch
 - Maneuver analysis
 - Center of mass location tracking and trim maneuver analysis
 - KBR boresight/Star Camera alignment maneuver analysis
 - Star Camera/Accelerometer alignment analysis
-

Level 1 S/W - De-Aliasing

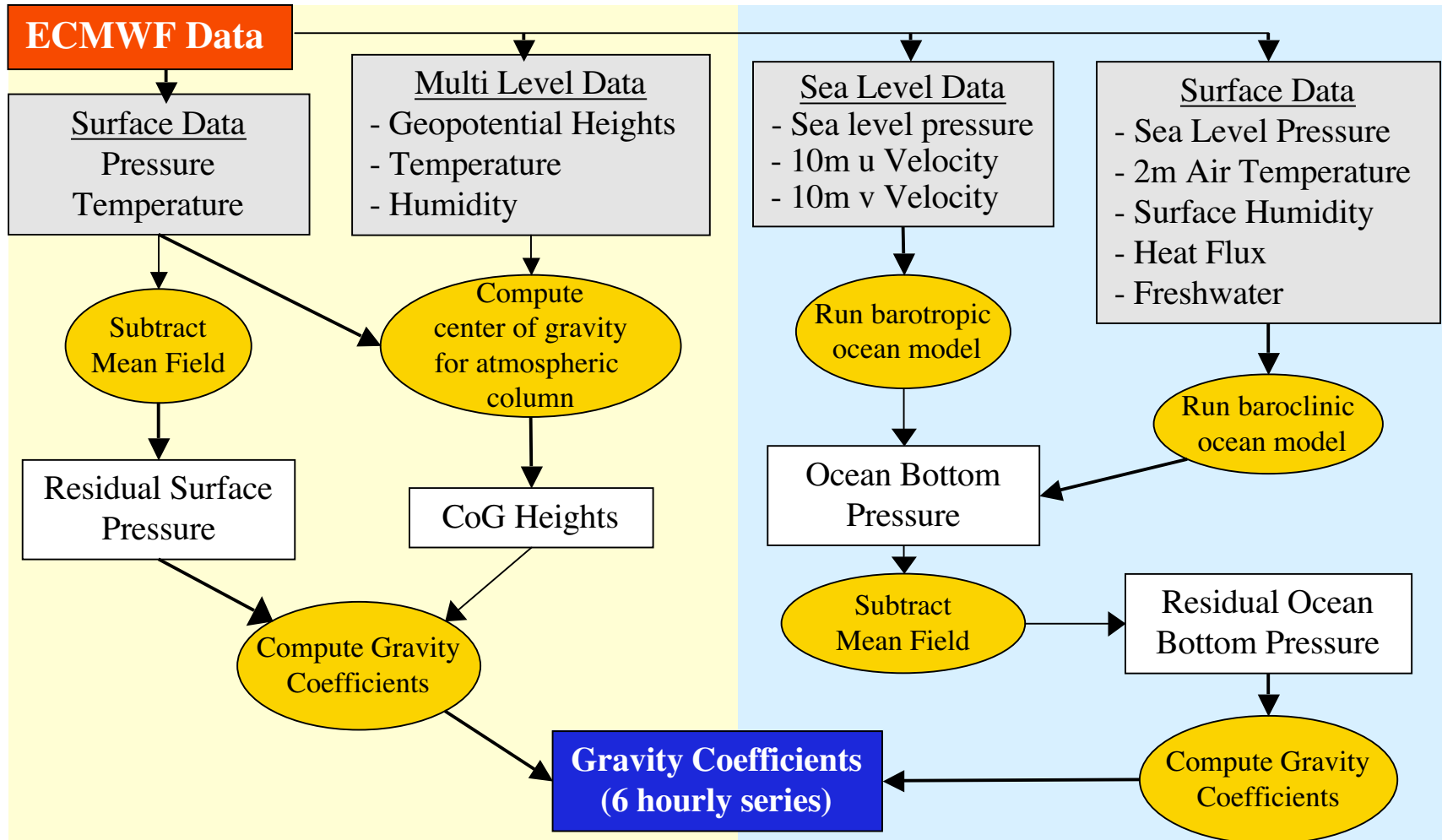

GRACE Satellites

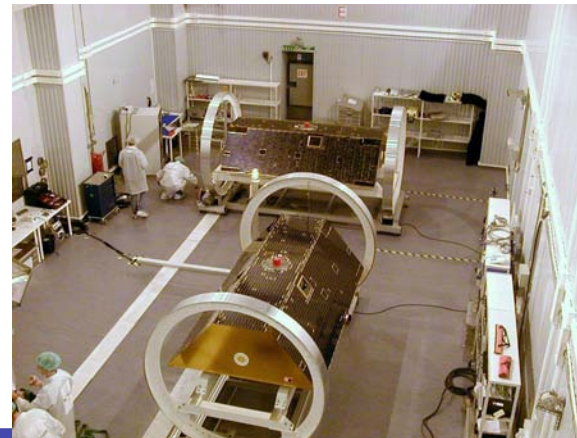
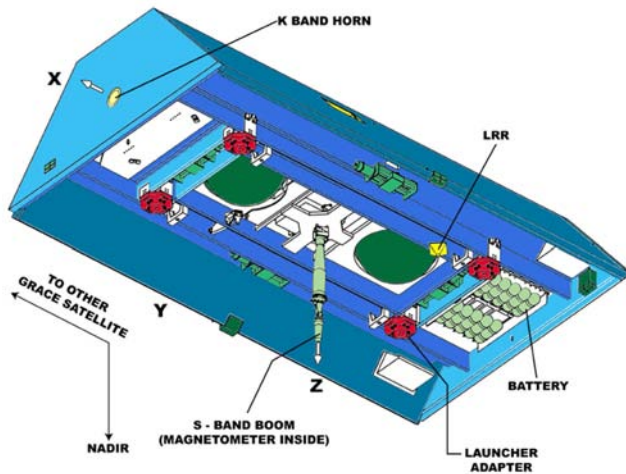
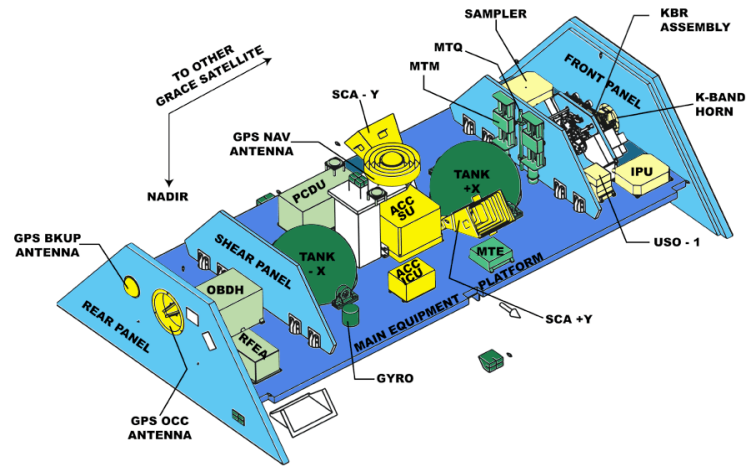
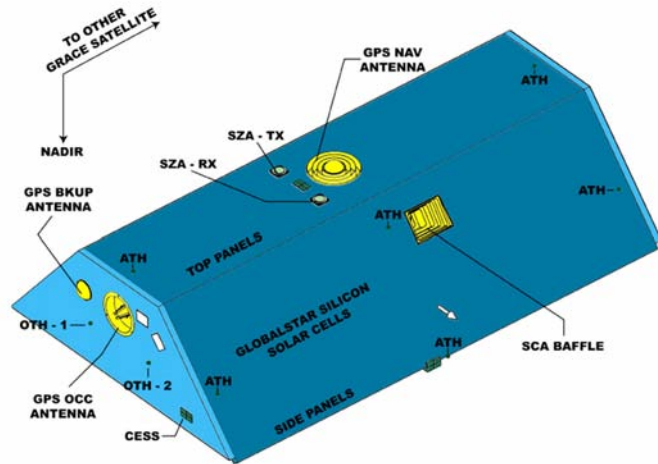

GRACE Distance Measurement

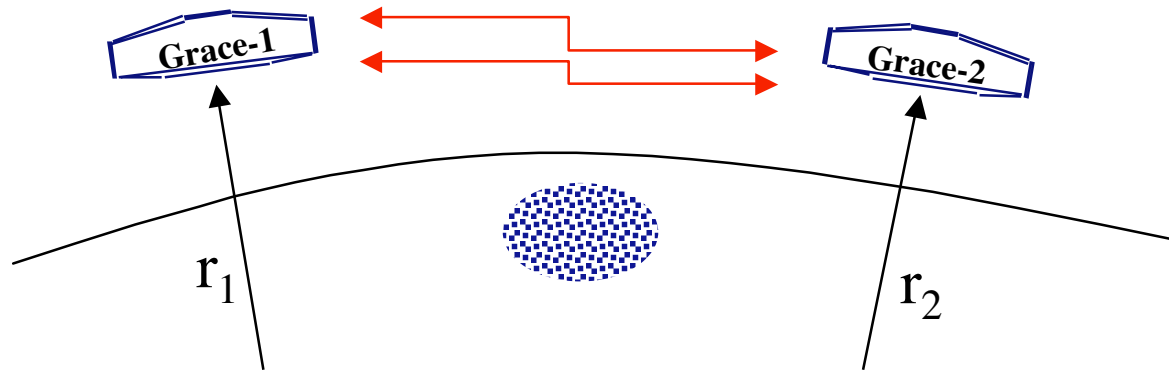

GRACE Measurement: Distance Change Between KBR Antenna Phase Centers (P.C.)

$$\Delta \rho(t) = \Delta \| r_1(t) - r_2(t) \|$$

: True C.G.-to-C.G. Range Change

+ C.G. Correction : C.G.-to-P.C. Vector Baseline
(Calibrated relative to Star Camera)

+ Dimensional Variations : e.g. - Thermal distortion of structure (x)
- C.G. Variations in satellite frame

+ Measurement Errors : e.g. - Multipath Errors (x)
- Electronic Noise (x)
- Time-tag Errors, etc.

(x) = is assumed small and not an SDS correction product

GRACE Accelerometer Measurement

$f_{\text{non-grav}}$ is measured with the accelerometer:

$$f_{\text{ACC}} = \text{Bias}(t) + \text{Scale}(t) [\text{Align} [\text{Rotate}(t) f_{\text{non-grav}}(r, v, \text{Drag}, \text{SRP}, \dots)]]$$

+ Parasitic Forces: [C.G. Offset-Angular Rates (x) -Gravity Gradient Couplings (x)]

+ Non-Linear Effects (x)

+ ACC Measurement Noise (x)

(x) = is assumed small and not an explicit or implicit SDS correction product (Bias/Scale & C.G. Offset calibrated in-flight)

L1 Processing Software Architecture

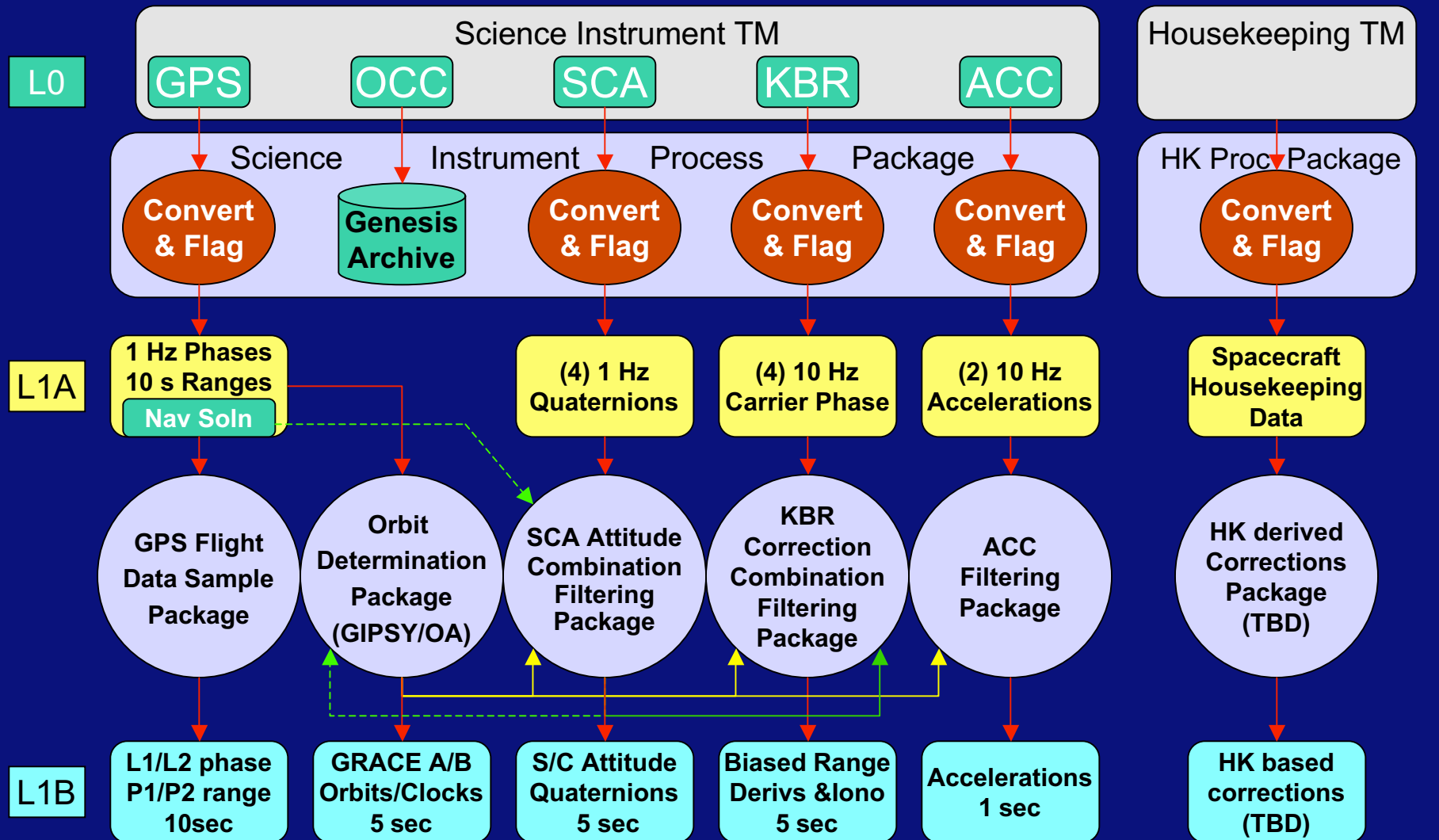

Gravity Field Formulation

Position of each satellite is an implicit and non-linear function of:

- $r(t_0)$ and $v(t_0)$: Initial Position and Velocity
- $f_{\text{grav}} [r(t), C_{\text{lm}}(t), S_{\text{lm}}(t)]$: Inferred in Data Analysis
 - $C_{\text{lm}}(t) = \langle C_{\text{lm}} \rangle$: Mean Gravity Field
 - + $dC_{\text{lm}}(t)$: Time variable gravity - to be estimated (30 days)
(Atmosphere, Tides, Hydrology (**x**), Oceans, ...)

(**x**) = is assumed small and not an SDS product or correction

Gravity Field Determination

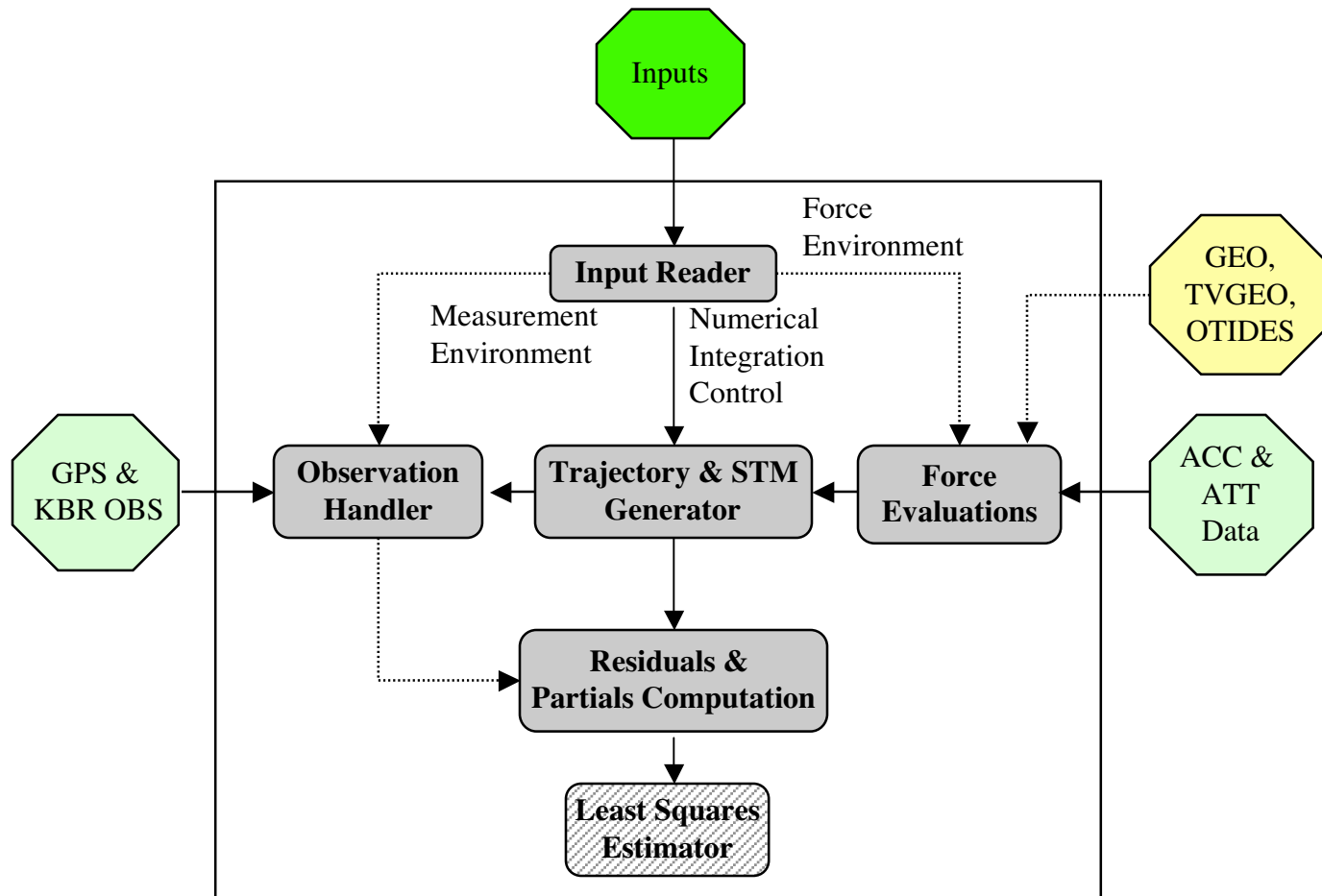

Level-2 Data Flow (CSR)

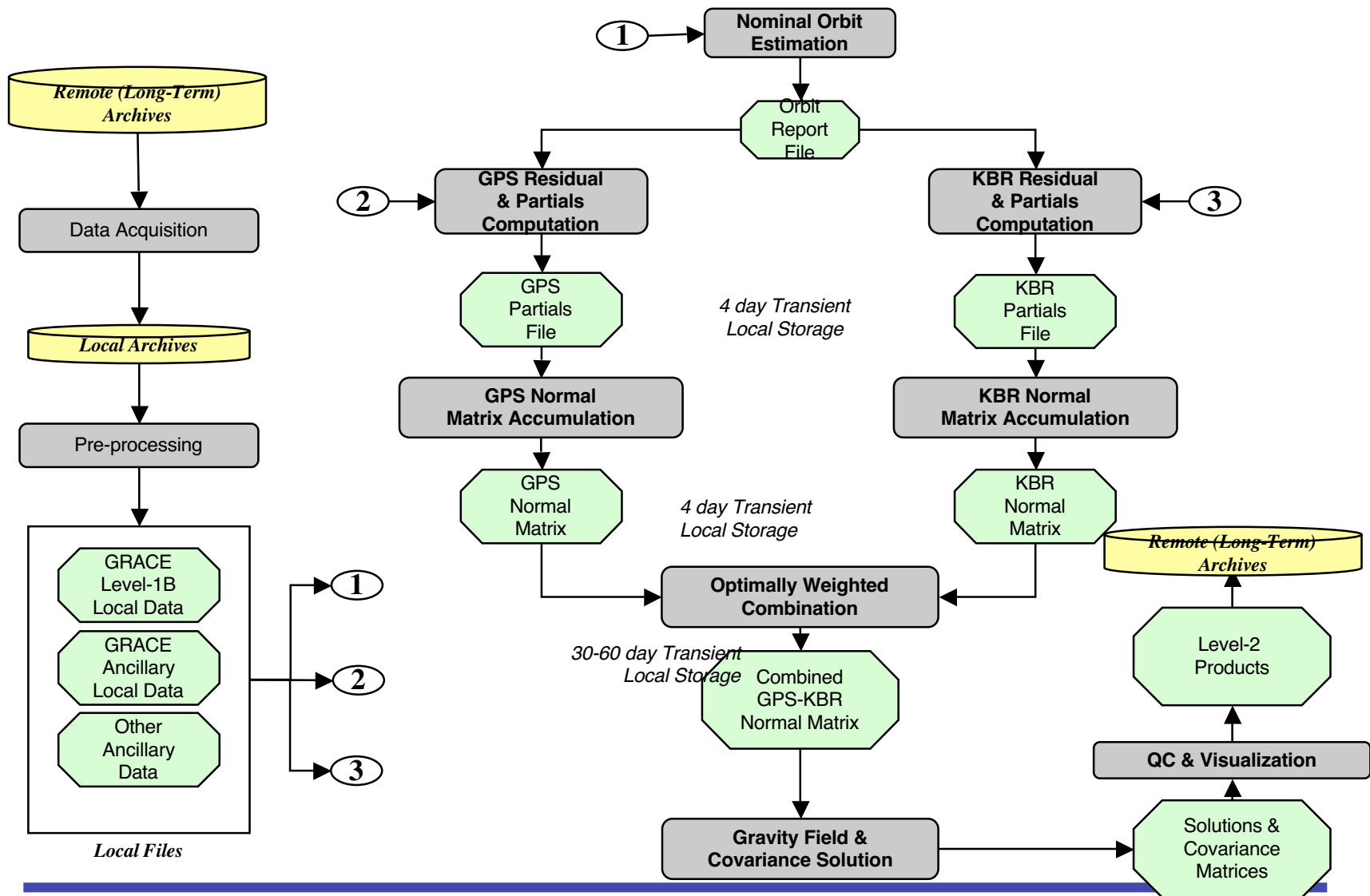

SDS Manager Summary

- Tremendous effort by small team at both Level-1 and -2
 - Data products of excellent quality are being routinely produced by the SDS
 - Algorithms now stabilizing
 - Evolved rapidly as team analyzed on-orbit performance
 - Reprocessing completed for entire mission
 - Ongoing product quality improvement
 - Quality assessment/Calval (even more) difficult than expected (detail in later talks)
-

GRACE Level-1 Product Description

Gerhard Kruizinga

Willy Bertiger

Chris Finch

Larry Romans

Michael Watkins

Sien Wu

Overview

- **Introduction**
- **Mission Data Flow**
- **Level-1 Data Product Description**
- **Level-1 Data Examples for a Selected Ground Track on 3 May 2002**

Data Flow

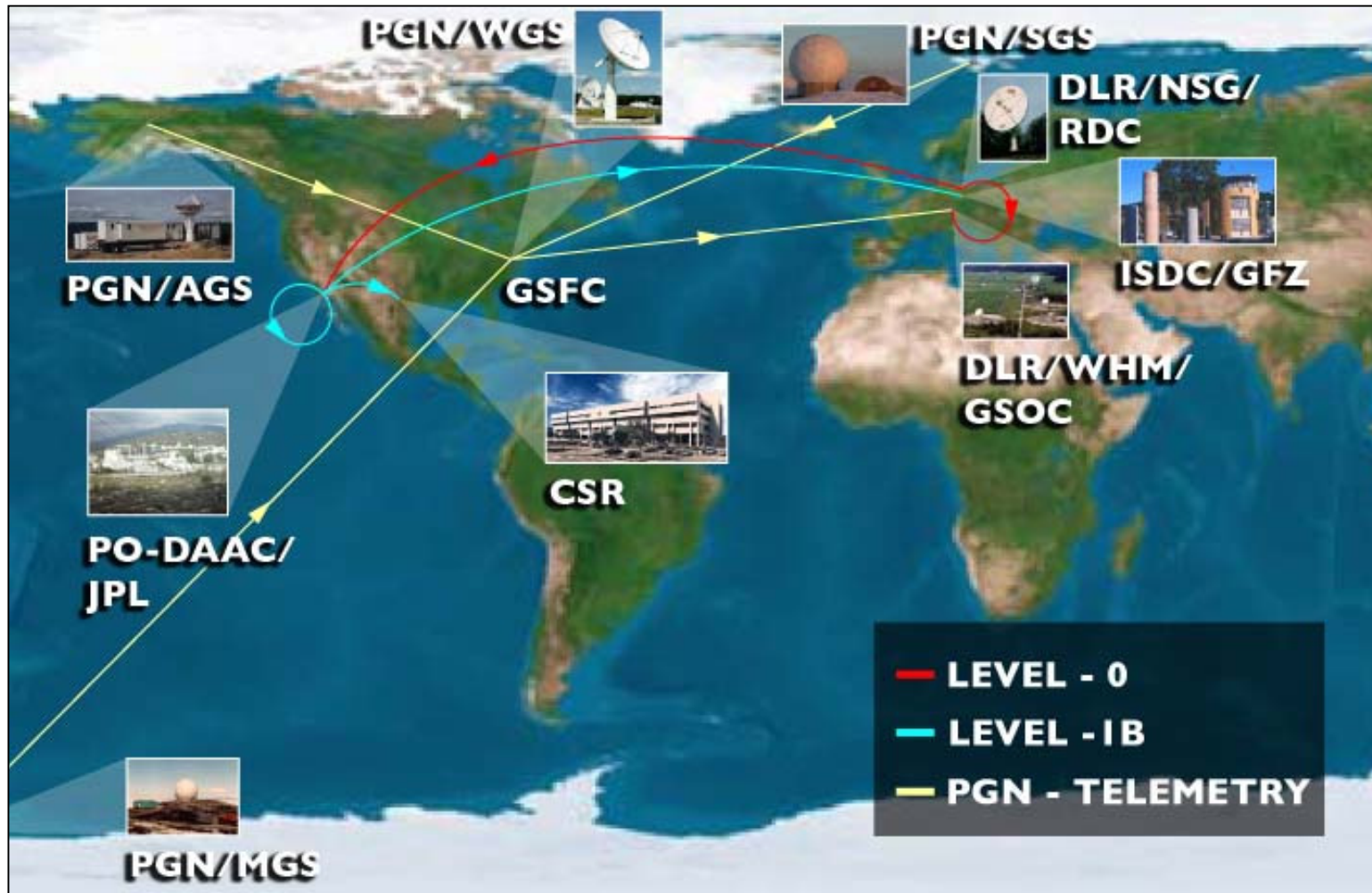

Data Flow Statistics as of 19 September 2003

- **99.8 % of raw data has been retrieved successfully and reformatted by the Science Data System (data latency < 1.0 hour)**
- **536 days of Level-1B data have been distributed to the level-2 centers (CSR, GFZ ,JPL) (data latency < 12 days)**
 - **517 days which passed KBR quality check**
 - **462 days all instruments available**

GRACE Science Instrumentation

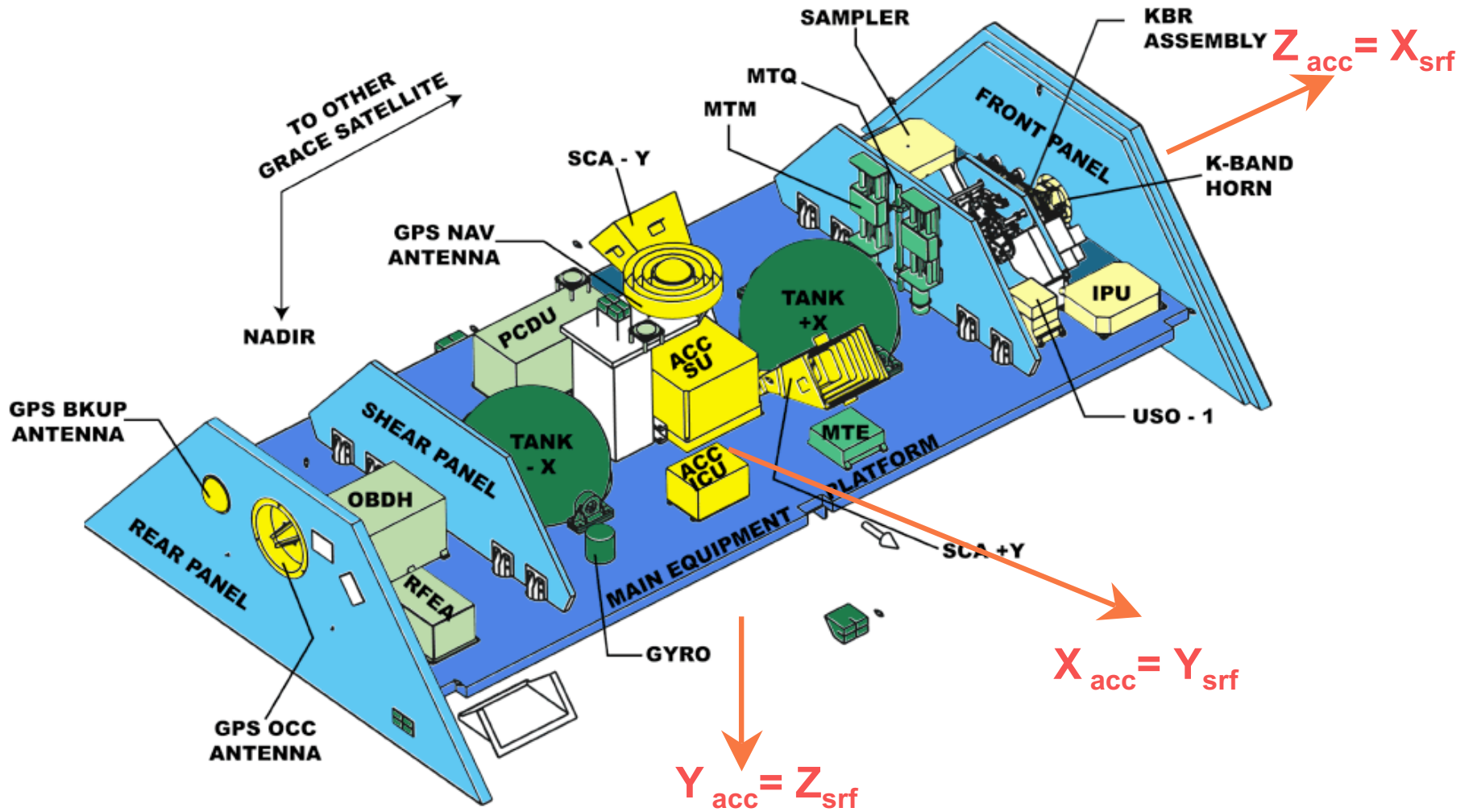

L1 Processing Software Architecture

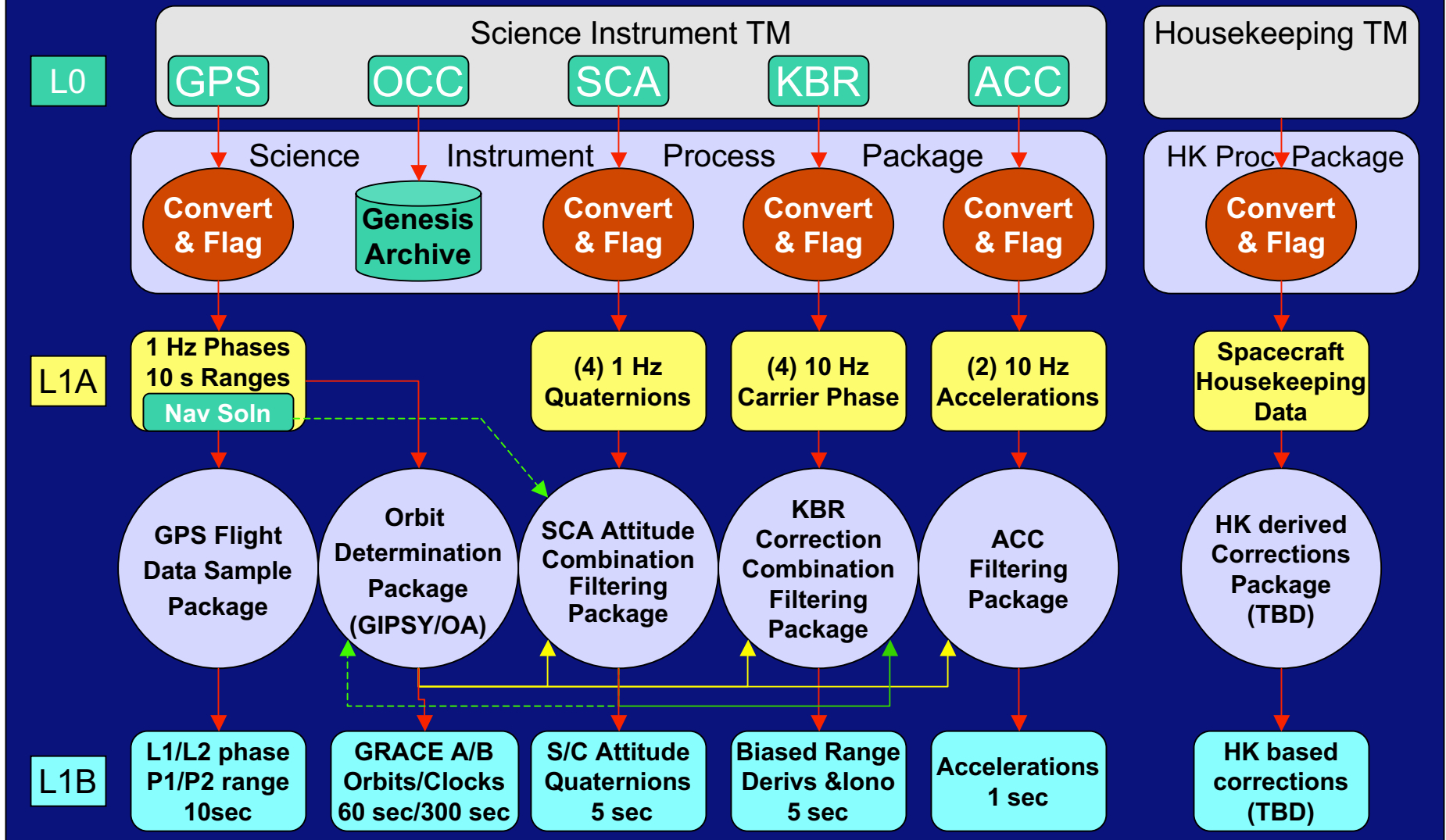

GPS instrument



Level-1 GPS Data Processing

- **Reformat phase, pseudo range + auxiliary data (L1A)**
- **Data compression from 1 Hz phase to 0.1 (L1B) which includes:**
 - **Continuity check + cycle slip flagging**
 - **Data editing**
 - **Estimate onboard clock offset using orbit determination program GIPSY/OASIS-II**
 - **Estimate frequency of onboard Ultra Stable Oscillator (USO)**
 - **Apply time tag correction and re-interpolate phase and pseudo range**

Accelerometer (electronics and sensor unit)

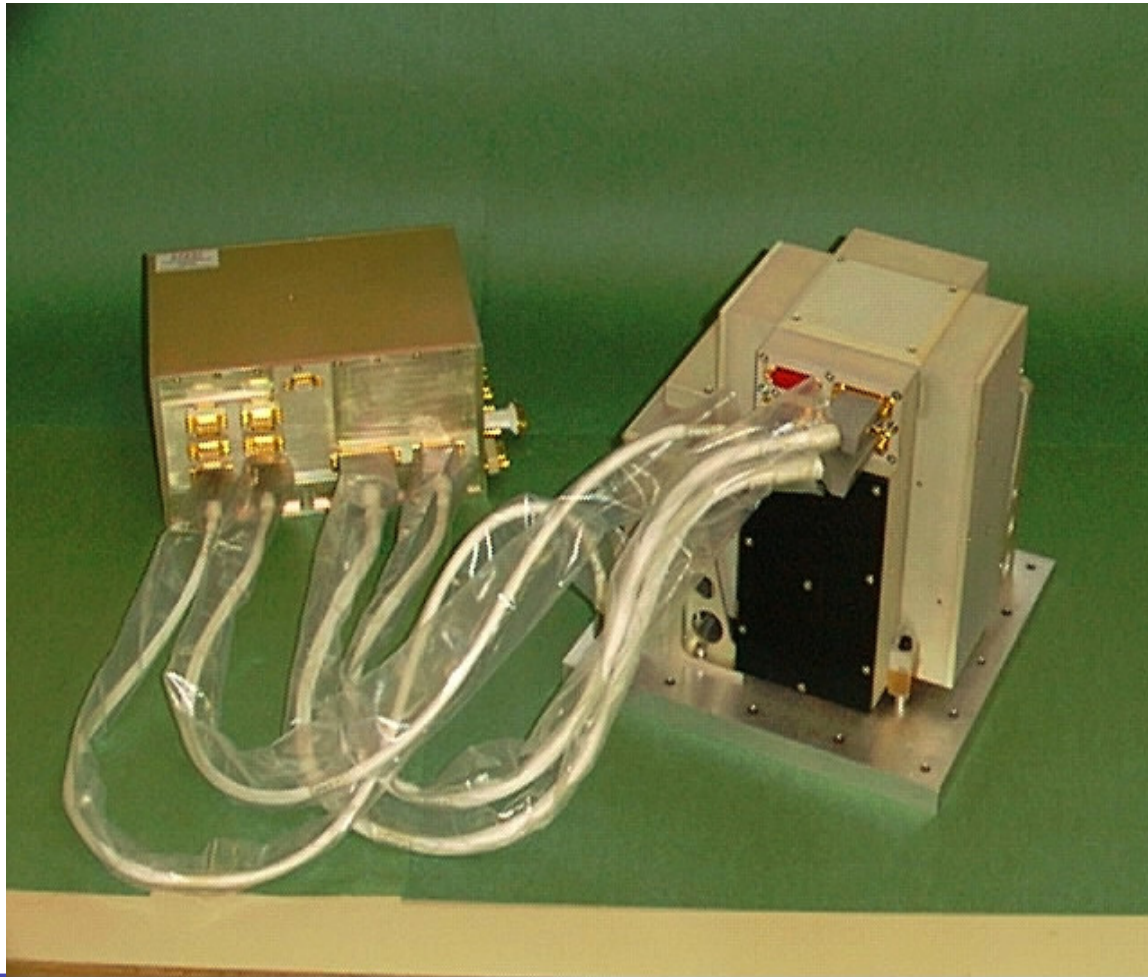

Sensor Axes

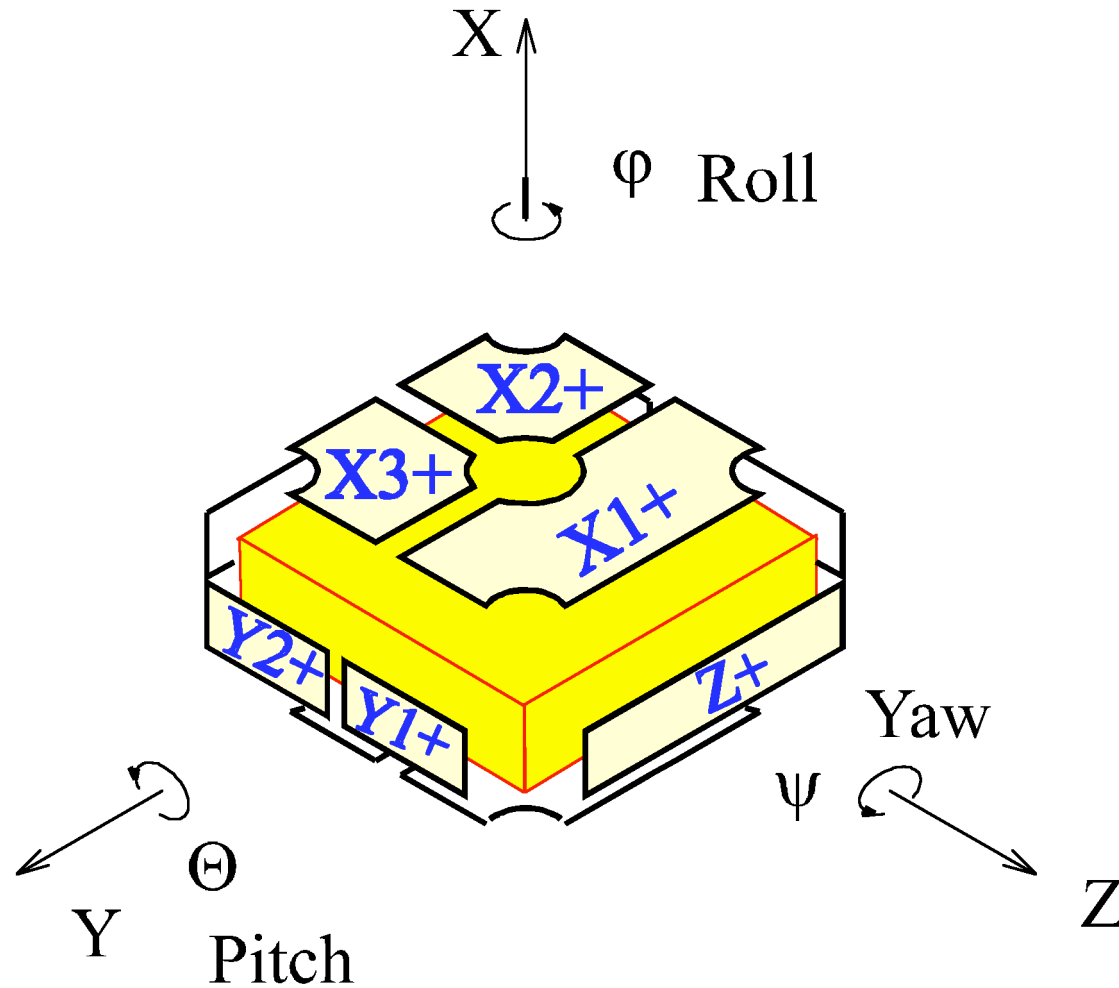

Level-1 Accelerometer Data Processing

- **Convert voltage measurements into linear and angular accelerations (L1A)**
- **Data compression from 10 Hz linear accelerations to 1Hz (L1B) which includes:**
 - **Data editing and small data gap filling**
 - **Apply time tag correction**
 - **Self Convolution of a Rectangular time window of degree 7 (CRN) filter with parameters:**
 - **Low pass filter bandwidth 35 mHz (window 140 sec)**

Relative Along Track Acceleration Comparison (ACC1B + THR1B)

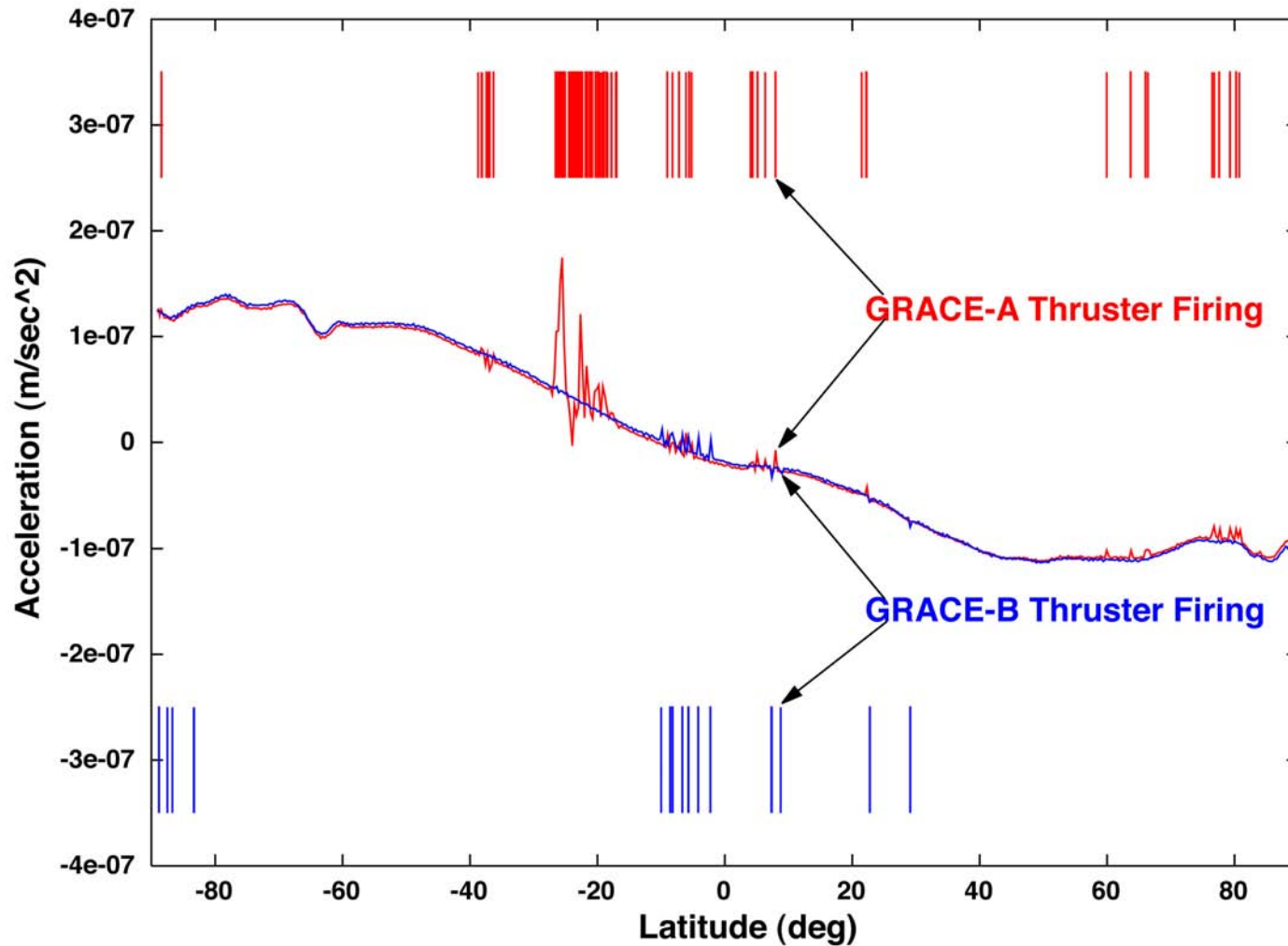

SCA instrument



Level-1 Star Camera Data Processing

- **Reformat quaternion data (L1A)**
- **Data compression from 1 Hz to 0.2 Hz (L1B) which includes:**
 - **Apply SCA-ACC alignment to convert quaternions to the GRACE Science Reference Frame (SRF)**
 - **Data editing and small data gap filling**
 - **Apply time tag correction**
 - **Data compression using quadratic fit over 5 seconds**
 - **Dual SCA combination (when available)**

Roll/Pitch/Yaw Each Camera Head

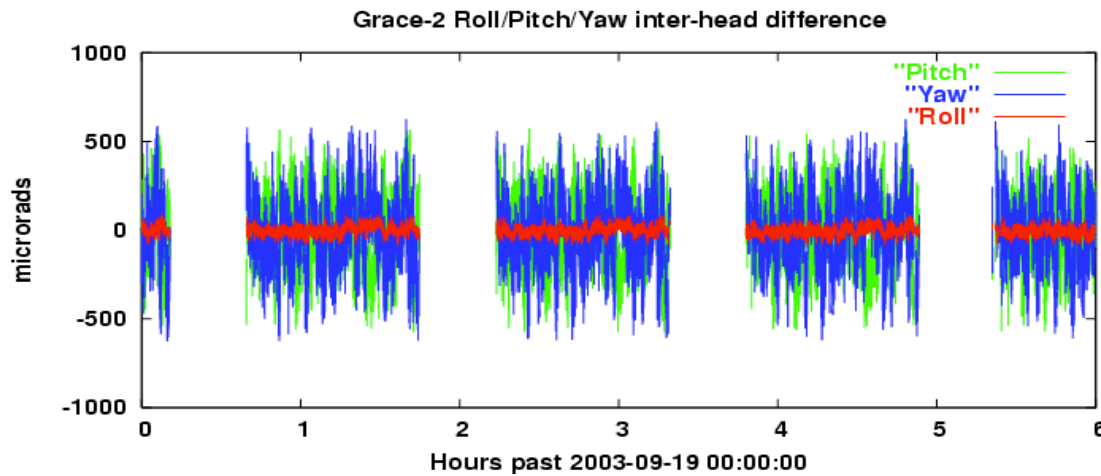
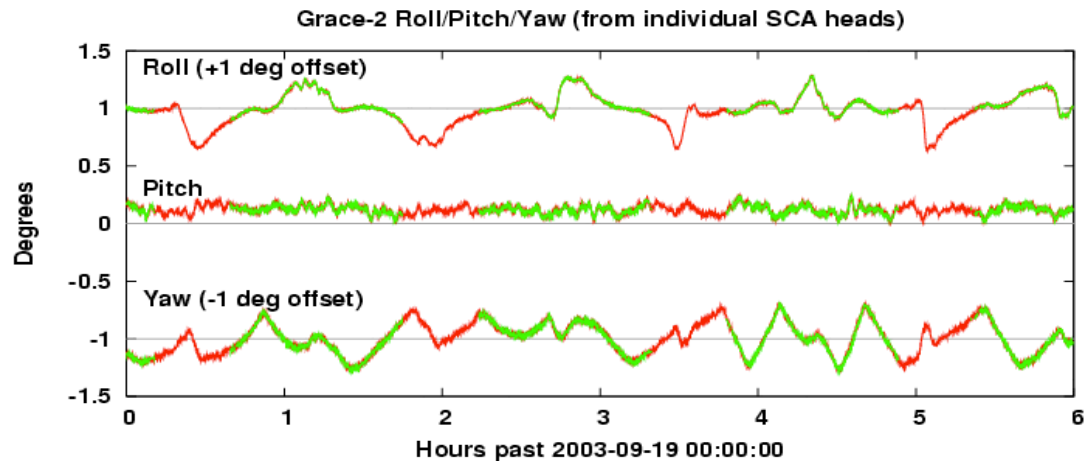

KBR instrument

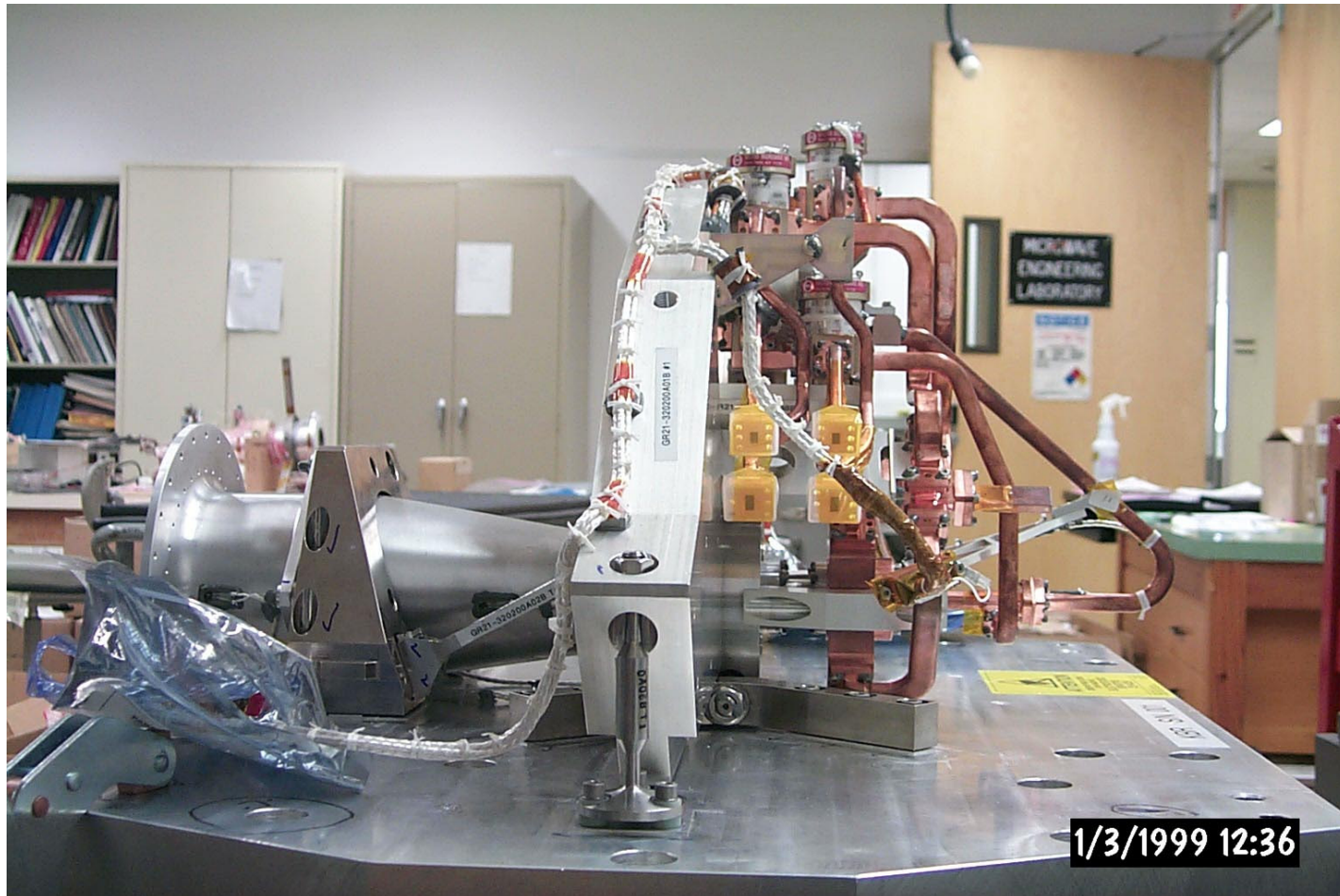

Level-1 KBR Data Processing

- **Reformat phase and auxiliary data (L1A)**
- **Data compression from 10 Hz phase to 0.2 (L1B) which includes:**
 - **Continuity check + cycle slip flagging**
 - **Data editing (SNR) + small data gap filling**
 - **Apply time tag correction and form Dual One Way Range (DOWR)**
 - **CRN filtering of DOWR (cut off 100 mHz)**
 - **Biased Range, Range-Rate, Range-Acceleration**
 - **Compute KBR observable corrections for:**
 - **Light time correction**
 - **KBR phase center mapping to Center of Gravity**

Sample Ground Track for 3 May 2002

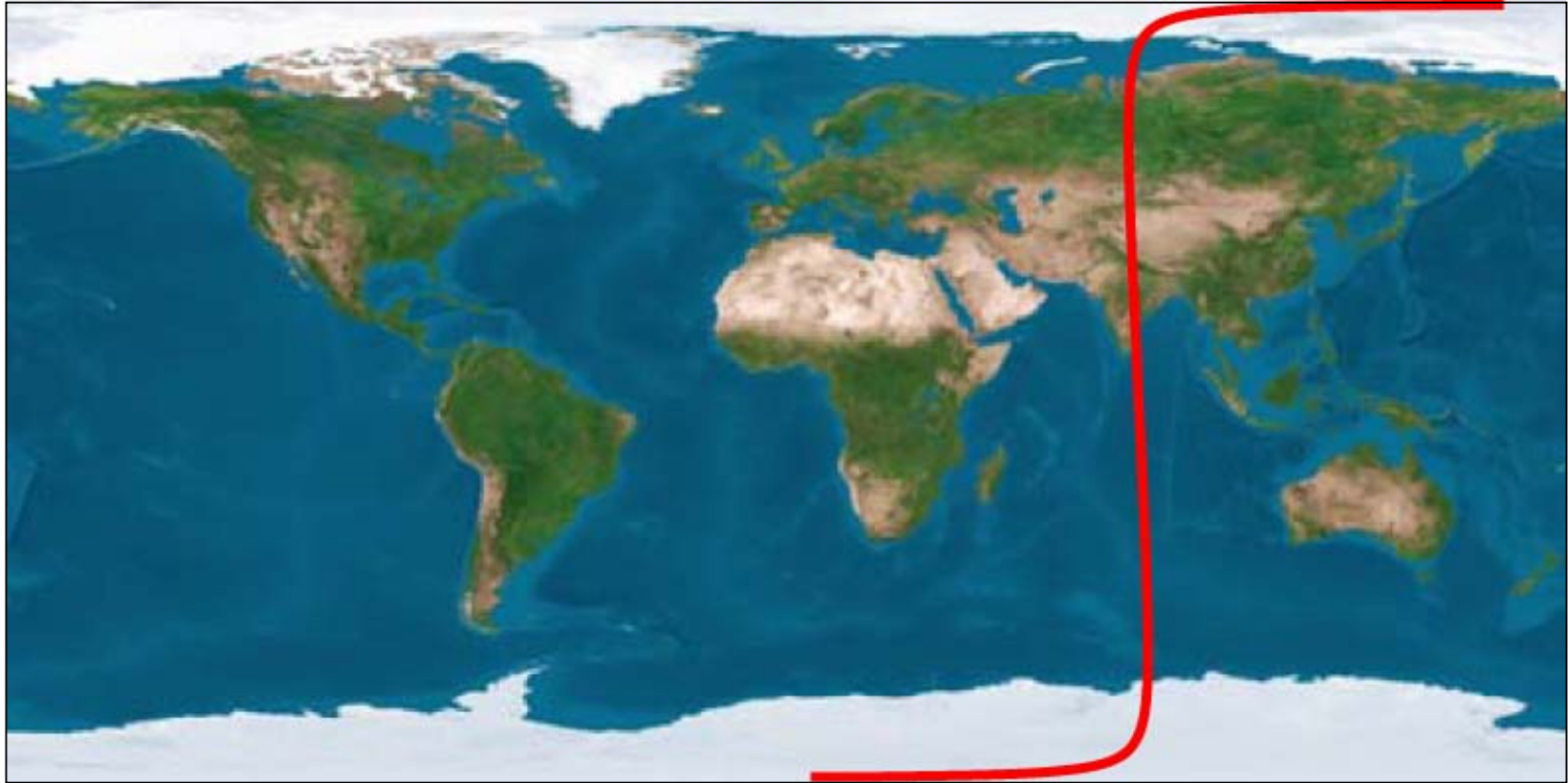

High Frequency Content of KBR Dual One Way Range Measurement (KBR1B)

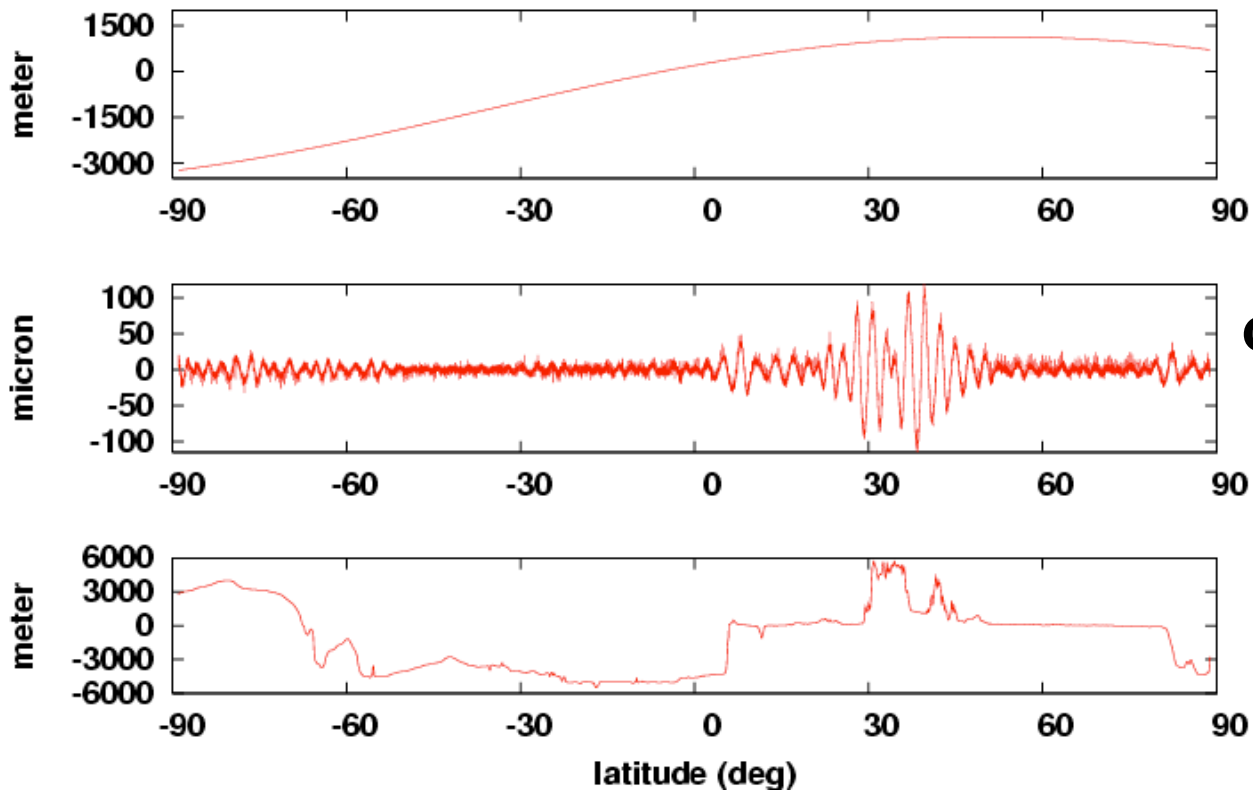

**Full KBR
Range - Bias**

**Cubic Spline Residual
(30 second knots)**

**Topography
Along Groundtrack**

Housekeeping Data

- **Housekeeping (HK) data for each Spacecraft**
 - **Accelerometer HK (AHK1B)**
 - **IPU HK (IHK1B)**
 - **Magnetometer data (MAG1B)**
 - **Satellite Mass (MAS1B)**
 - **Thruster Activation data (THR1B)**
 - **Timing information (TIM1B)**
 - **Cold gas Tanks data (TNK1B)**

Additional Level 1B products

- **Atmosphere Ocean De-aliasing produced by GFZ (AOD1B)**
- **Satellite constants (only released when updated)**

- **Final notes:**
 - **Quality report files for each product**
 - **Total number of files 57+ PO.DAAC/JPL ftp server**
 - **ISDC/GFZ distribution similar to CHAMP data**
 - **Data Latency 12 days**



Data Flow @ GFZ, Level-1 Backup and SLR Status

Frank Flechtner

GeoForschungsZentrum Potsdam (GFZ)
Department 1 "Geodesy & Remote Sensing"

GRACE Science Team Meeting
Austin, TX, October 8-10, 2003



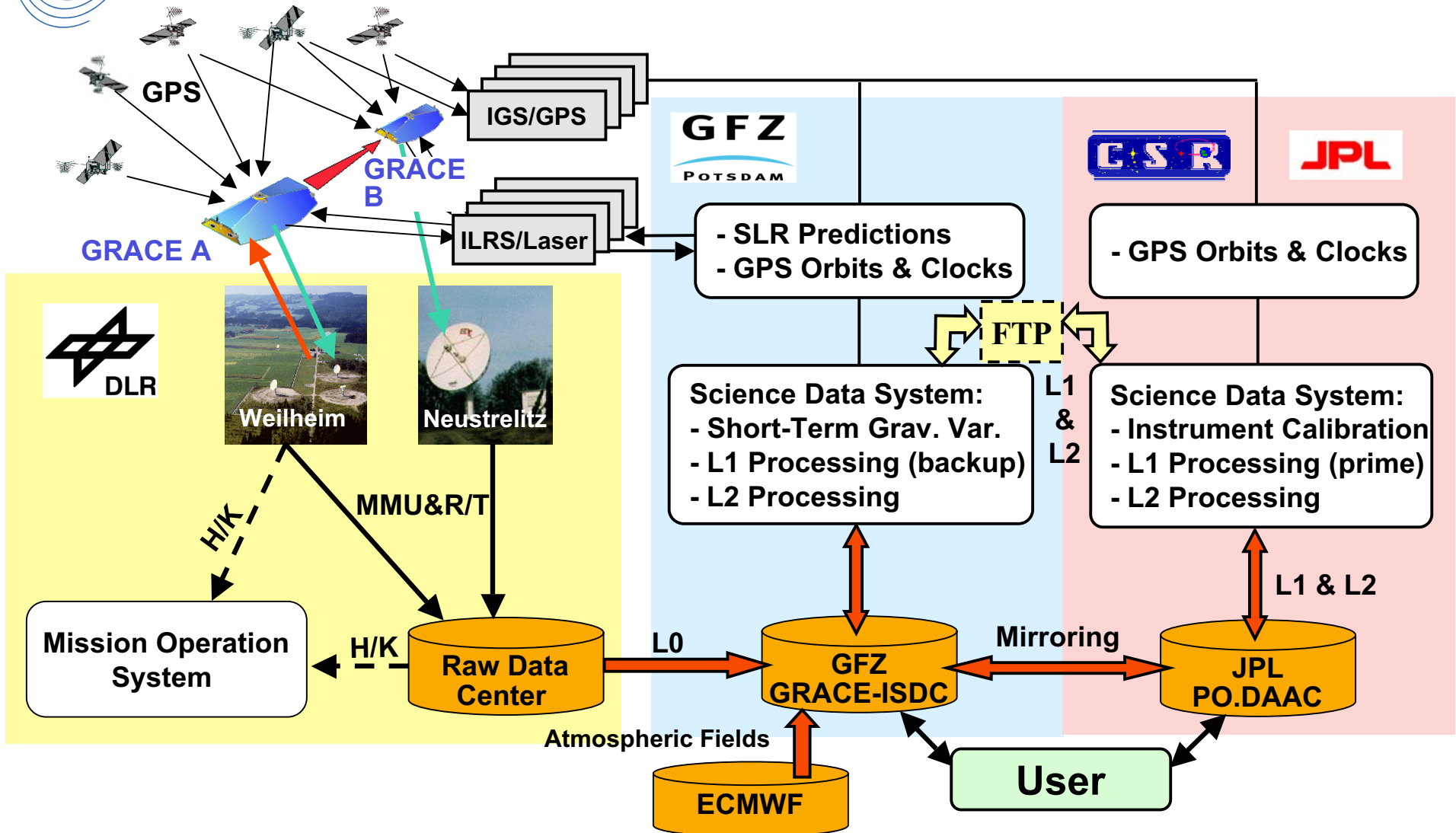

- L1 software implementation @ GFZ still status April 2002.
- Used for routine extraction of GPS navigation solution from Level-0 data for SLR prediction generation (2/d).
- Updated JPL L1 software planned to be installed at GFZ in early 2004 (workforce constraints @ JPL).
- Interfaces (orbits, clocks) between EPOS and L1 software partly coded, still work to be done.
- Tests have to be performed to prove the backup capability (Spring 2004).

- CHAMP-type Laser Retro-Reflector for GRACE-A/B provided by GFZ
- SLR data used for assessment of POD based on microwave tracking data from GPS Black Receivers and KBR instrument
- Orbit predictions for GRACE-A/B for ILRS ground station network based on the navigation solution from GPS BlackJack onboard receivers and SLR data.
- Currently 2 updates/day/GRACE-satellite sufficient to meet orbit prediction accuracy requirement (~ 70 ms in along-track to enable day-light tracking).

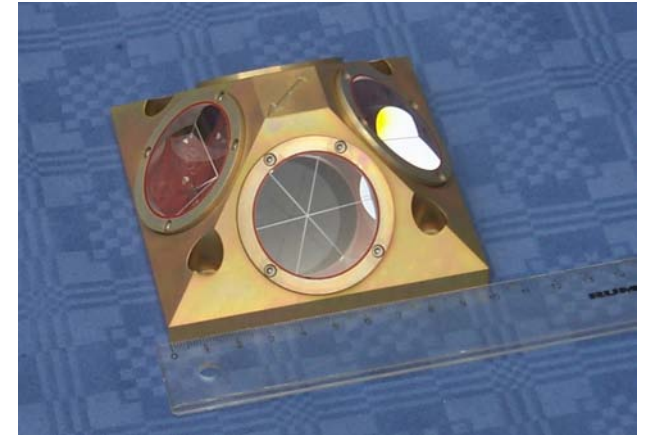

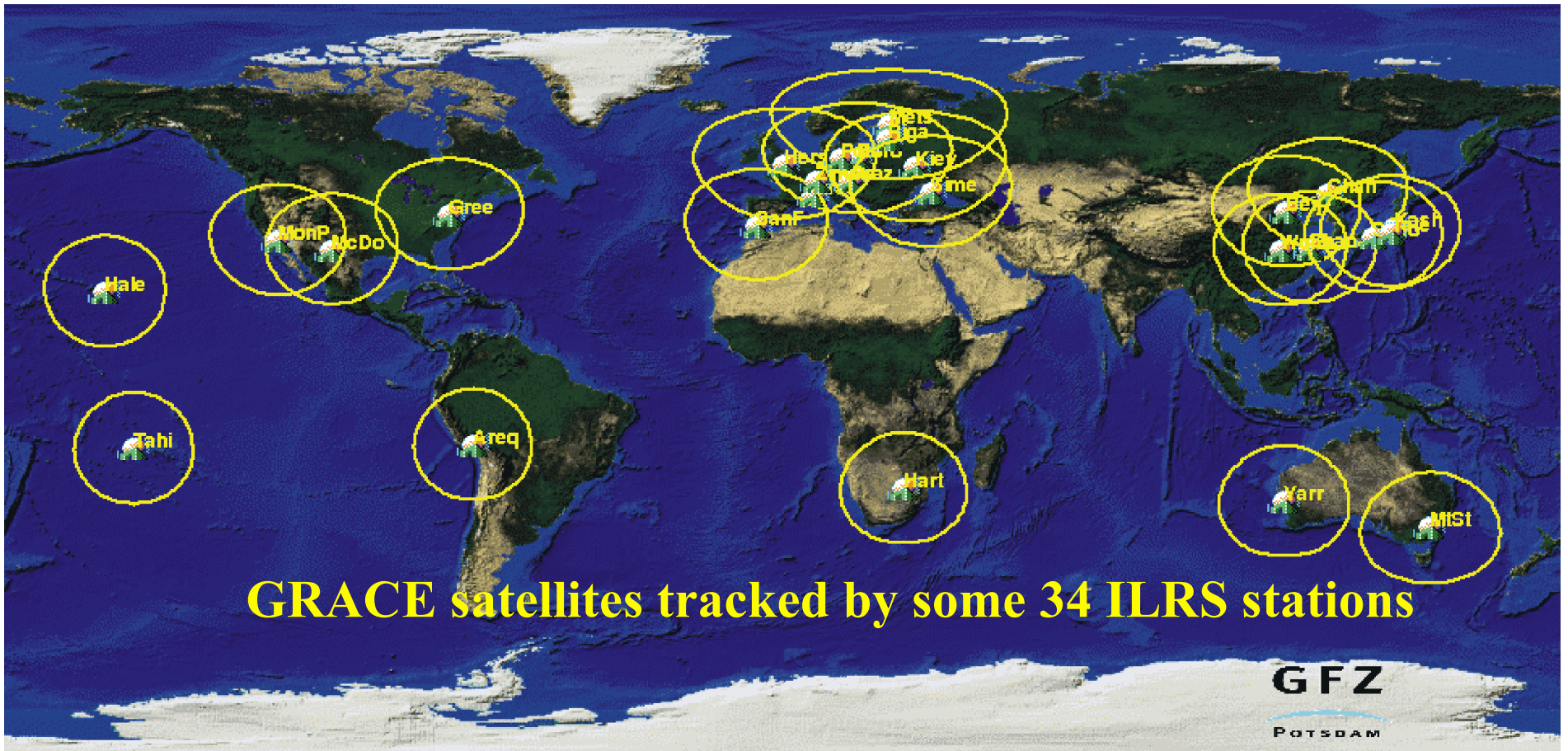

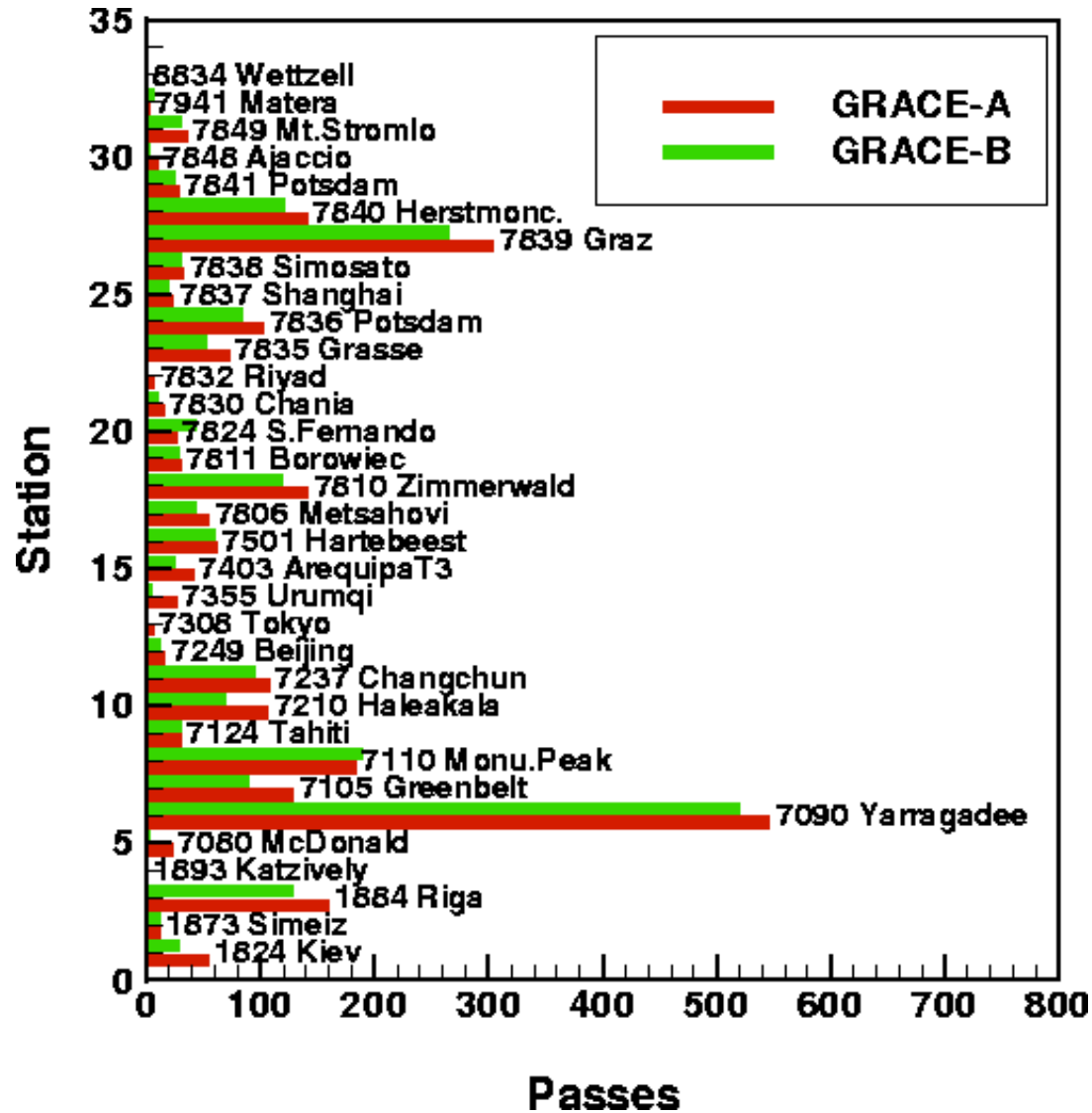

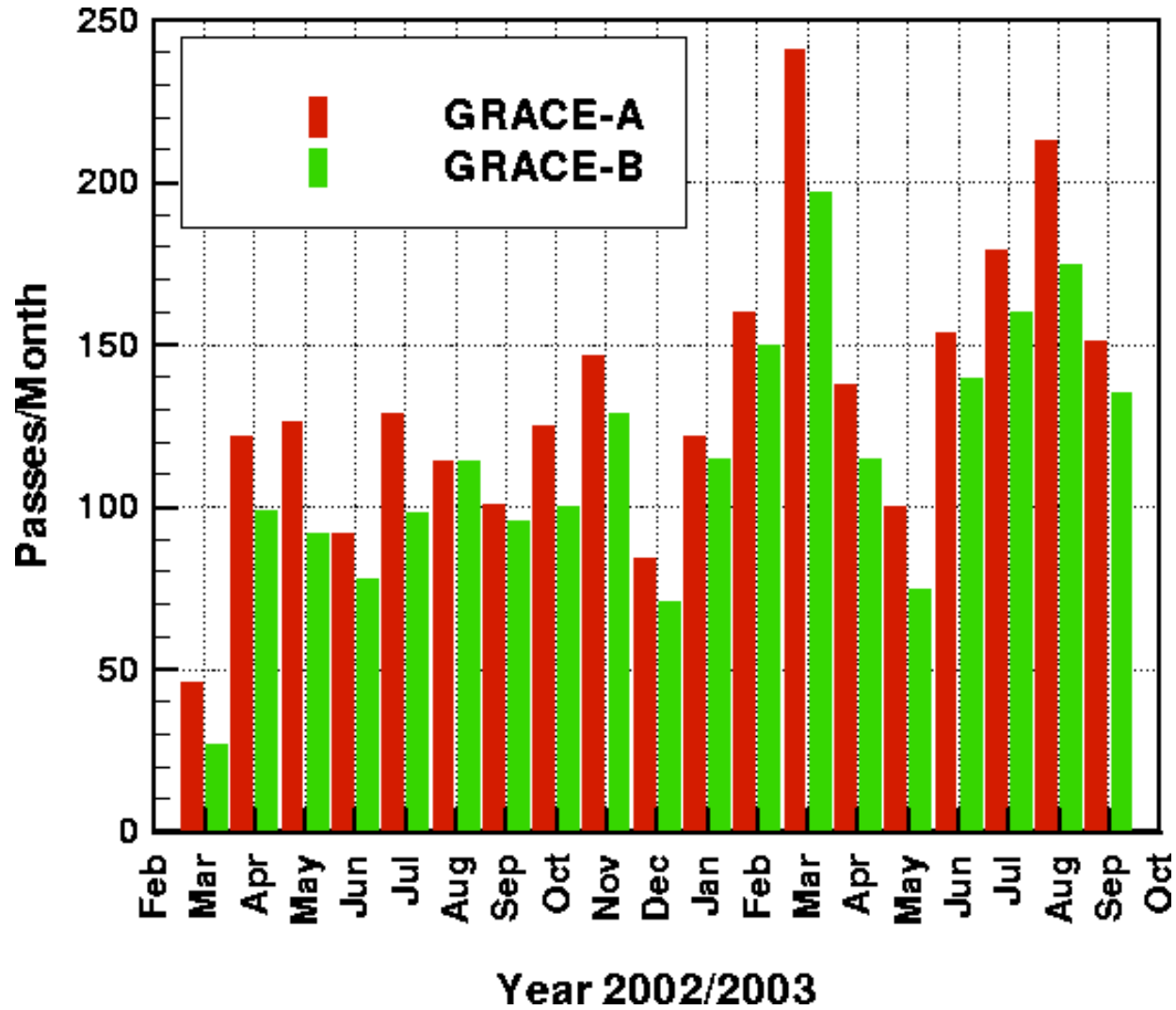



SLR RMS and #Observations April 2003

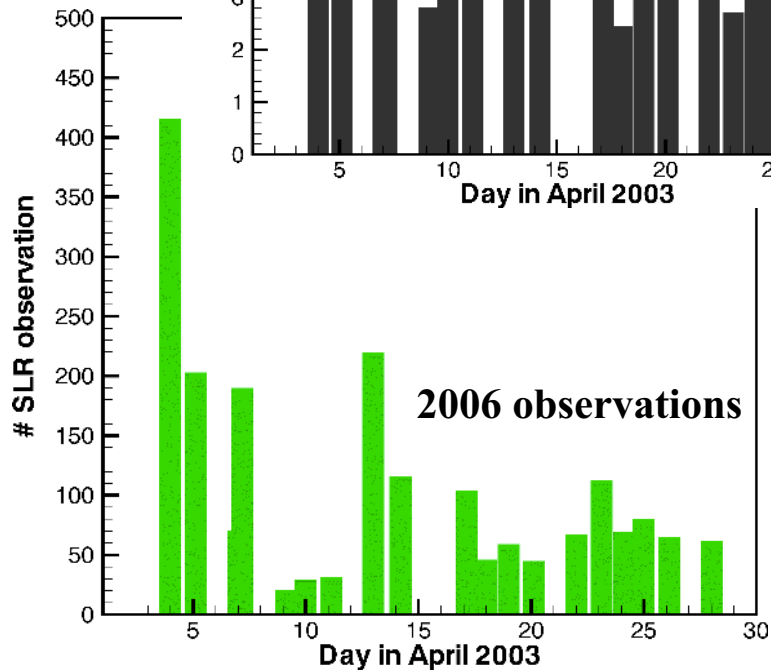
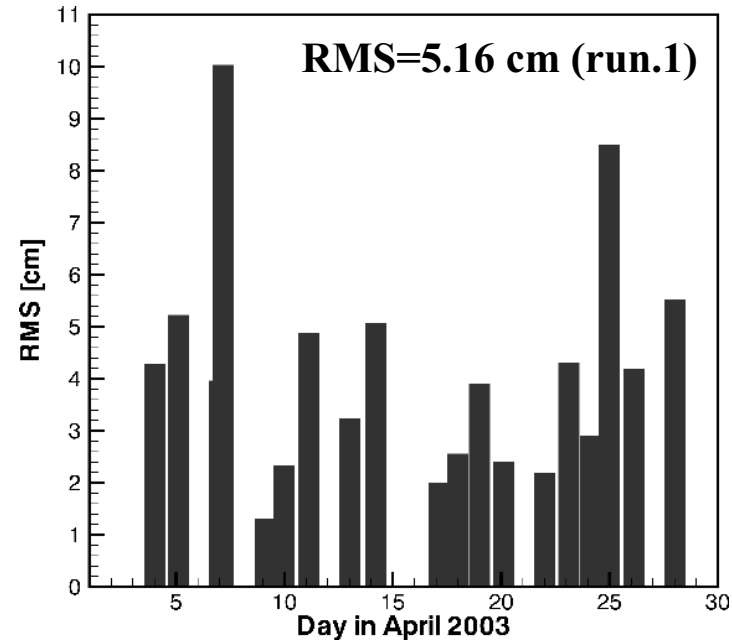
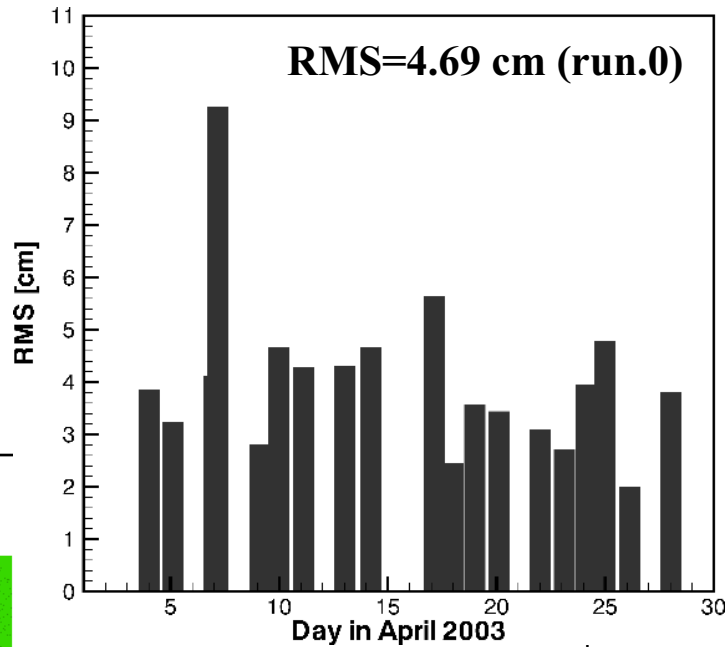

- Varying contributions from station to station reflecting the capability of the ILRS network typical for Low Earth Orbiter (LEO) missions. Statistics comparable to CHAMP.
- ILRS stations try to keep balanced tracking of GRACE-A/B, however in general stronger tracking of GRACE-A.
- Overall amount of SLR data quite satisfactory. Good quality of SLR data.
- Decaying orbit will need increased update rate of orbit prediction to 3 updates/day/sat and more to maintain ILRS requirements. Increased frequency and availability of data dumps of the GPS navigation solution by a high-latitude telemetry stations needed, however.

Level-2 Gravity Field Determination

Peter Nagel

Gravity Field Determination

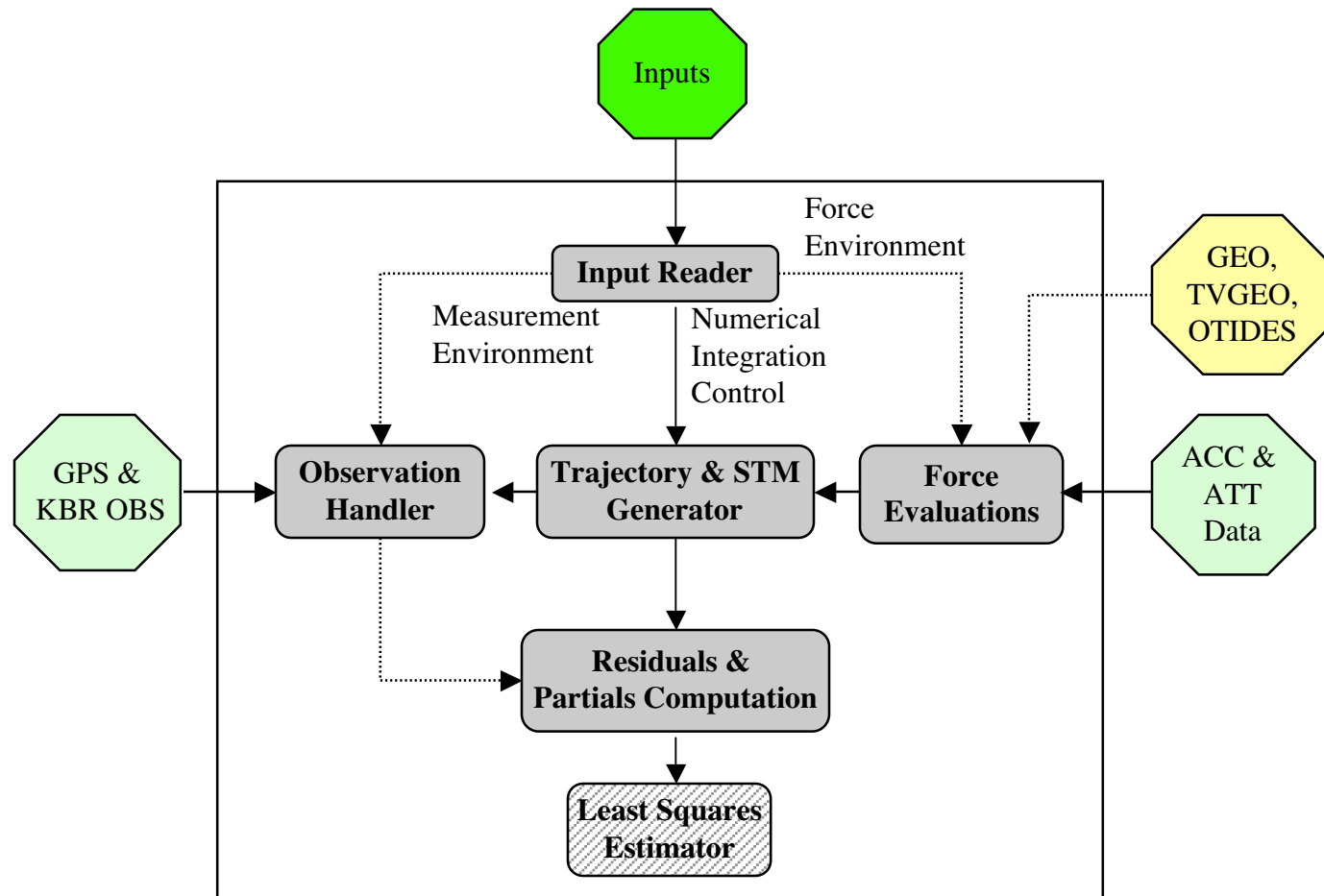

Parameter Estimation

- Parameters of the gravity field are in the form of spherical harmonic coefficients:

- The exterior potential of the Earth can be expressed as

$$V(r, \varphi, \lambda; t) = \frac{\mu}{r} + \frac{\mu}{r} \sum_{l=2}^{N_{\max}} \left(\frac{a_e}{r} \right)^l \sum_{m=0}^l \bar{P}_{lm}(\sin \varphi) \{ \bar{C}_{lm}(t) \cos \lambda + \bar{S}_{lm}(t) \sin \lambda \}$$

- We estimate the C and S terms, which gives us a single set of coefficients to describe the gravity field for an entire month.
- Additional parameters include those from the observation model and those from the dynamical models.
 - Selection of best parameterization is ongoing
 - Parameterization is fixed for a given release

Background Models

- Generally IERS2000 Compliant
 - Gravity Field: GGM01 or EIGEN-GRACE01S
 - Ocean Tides: CSR4.0 or FES2002
 - Solid tides & other models: IERS2000 compliant
 - Non-tidal Atmosphere+Ocean : AOD1B product
 - Station Coordinates: ITRF2000
 - Non-gravitational forces: ACC1B product
- All background geopotential models - as used in data processing - can be provided as science products
 - Complete documentation will be made available

Data Combination

- There are two primary observation types from GRACE that are used to compute observation residuals:
 - GPS observations (phase from GPS satellites to receivers on each Grace satellite)
 - Intersatellite range, range-rate, or range acceleration (from the KBR instruments on both spacecraft)
- The information from these two must be combined and weighted
- This is done using an Optimal Weighting scheme

Data Selection for Processing

- The ensemble of ACC, KBR, SCA & GPS data must be of sufficient quality for use in the gravity field determination process:
 - Useability of the data is re-evaluated during Level-2 processing
 - The data useability of the ensemble is not “flagged” before delivery of the products

GRACE Orbit Fits Using ACC

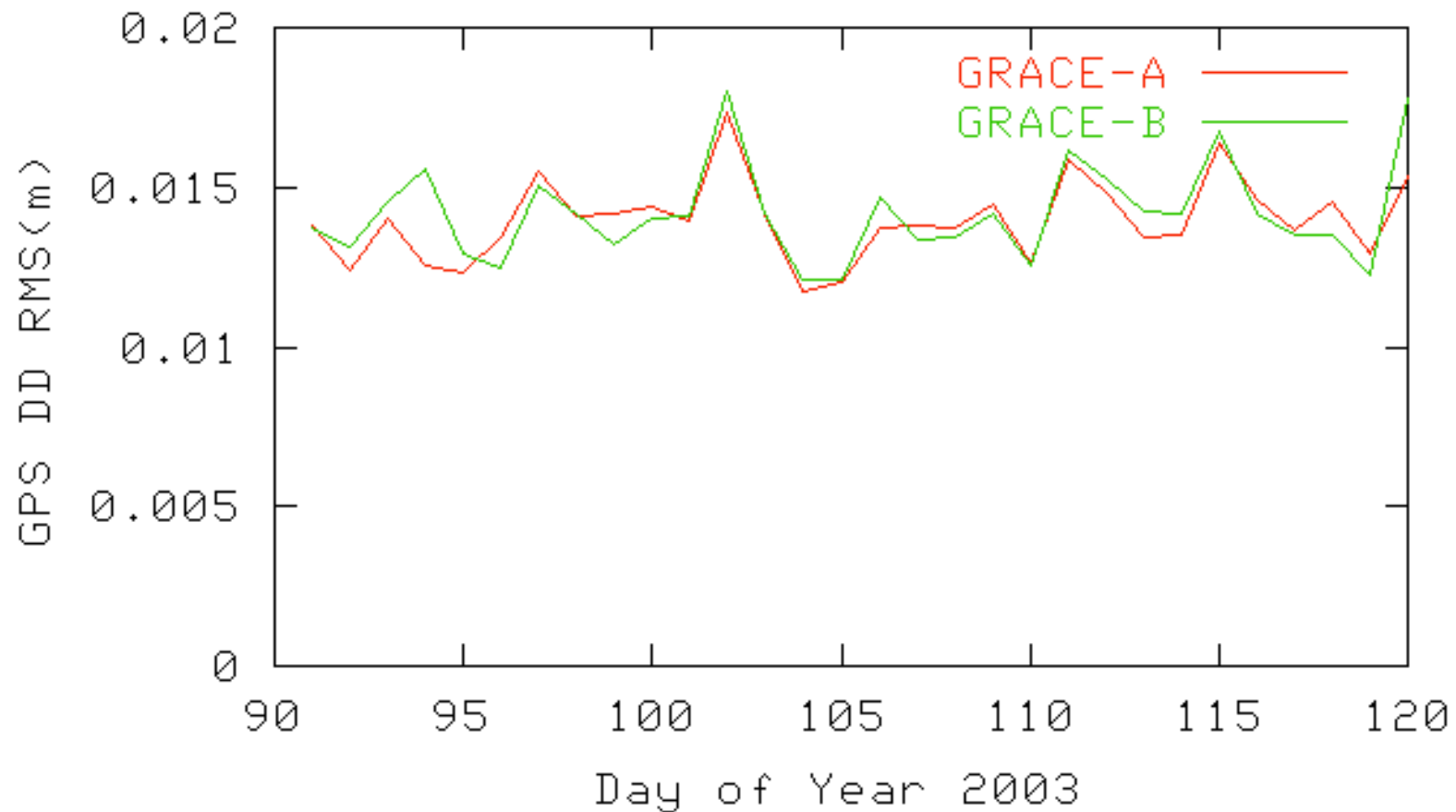

GRACE KBR Pre-Fit Range-Rate Residuals

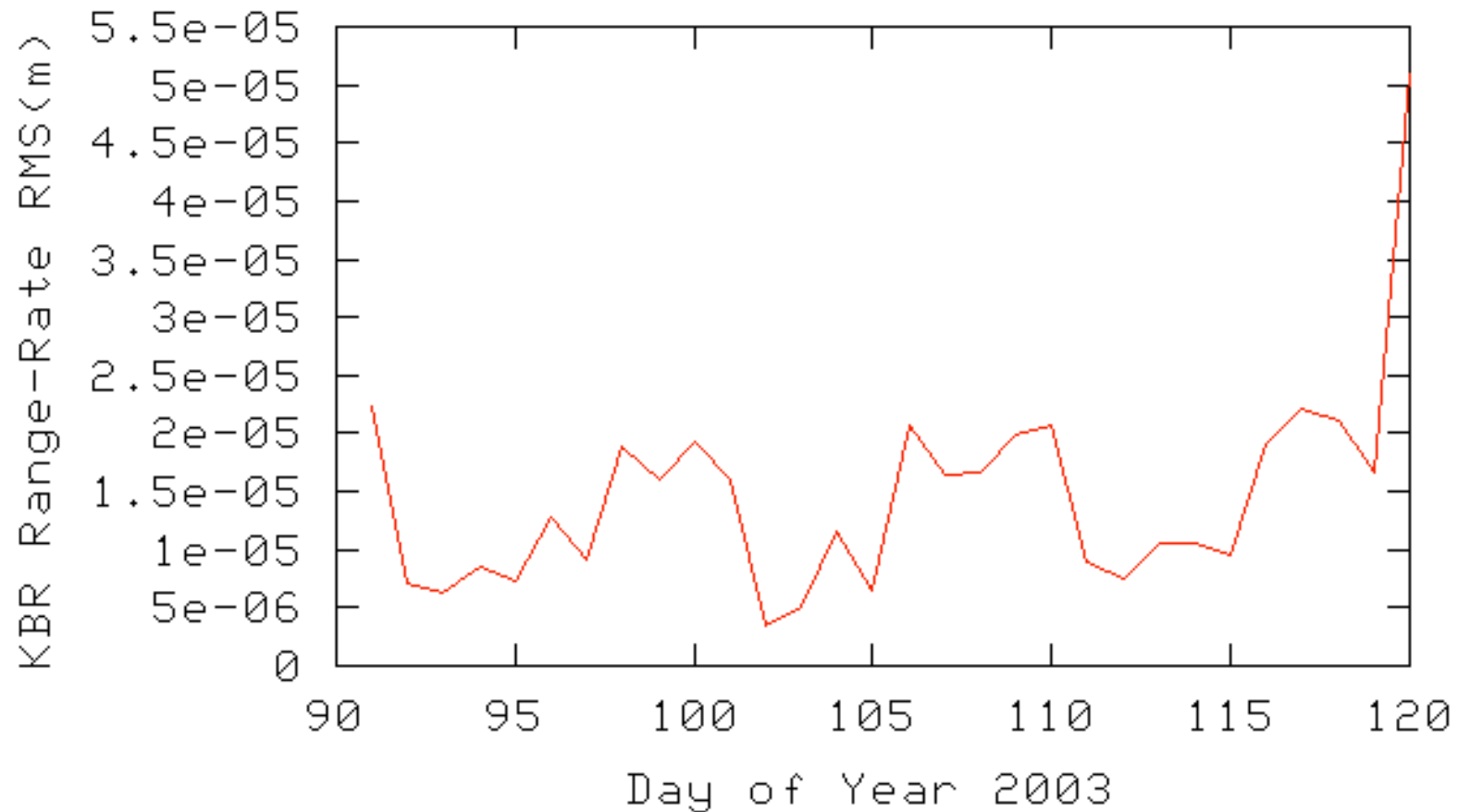

Level-2 Product Description

Exterior Geopotential

$$\begin{Bmatrix} \bar{C}_{lm} \\ \bar{S}_{lm} \end{Bmatrix} = \frac{1}{(2l+1)M_e} \times \iiint_{Global} \left(\frac{r'}{a_e}\right)^l \bar{P}_{lm}(\sin\varphi') \begin{Bmatrix} \cos m\lambda' \\ \sin m\lambda' \end{Bmatrix} dM(r',\varphi',\lambda')$$

- The provided spherical harmonic coefficients are to be used for evaluation of the external potential
 - Normalization & other conventions are in *Level-2 User Handbook*
- Time variability of the exterior geopotential is represented by time-variable geopotential harmonic coefficients
 - generally by piece-wise constant estimates
- Component variations (e.g. ocean, atmosphere, etc) used for Background Models are obtained by integration over a limited (non-global) domain
 - but still represent contributions to the external potential

Background Models

- Used to predict “best-known” observation values, before computing residuals to be used in least-squares adjustments
- These are a mix of analytic & time-series models
 - Also have diverse spatial resolutions
- Complete specification of the Background Models is given in the *Level-2 Algorithms Documents*
 - Generally compliant with IERS2000 Standards
- Level-2 Products from Background Models:
 - Time series or analytic model parameters - as appropriate
 - Average values for time-spans coincident with gravity solutions

Background Models - example

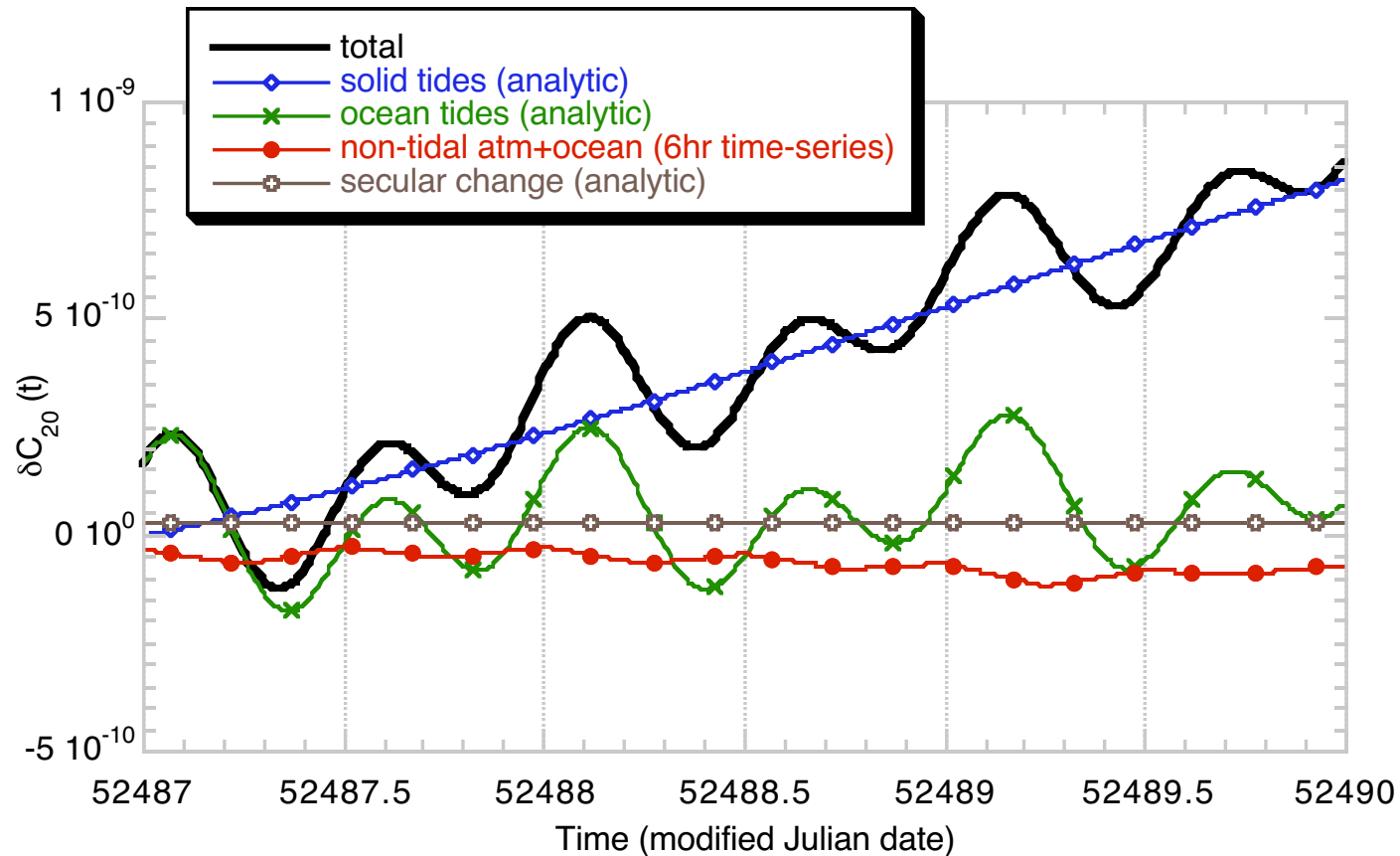

$$G^*(t) = \langle G \rangle^* + G' \cdot (t - t_0) + \delta G^{bt}(t) + \delta G^{ot}(t) + \delta G^{pt}(t) + \delta G^{a+o}(t)$$

Gravity Estimates

- Gravity Field solutions @ monthly intervals
 - Span determined by ground-tracks & on-board events
 - No assurance of contiguous data spans
 - Dates within estimate span is reported with 1-day granularity
- Generally, piece-wise constant parametrization
 - Future variations are possible
- Estimates may be conditioned or regularized
 - Decision by the end of Validation Phase
 - Description will be in *L-2 User Handbook*

Gravity Estimate - example

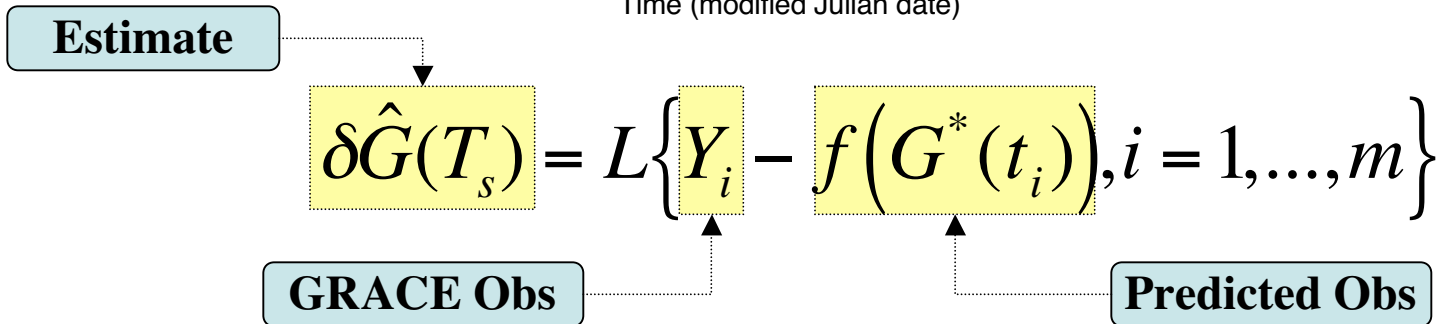
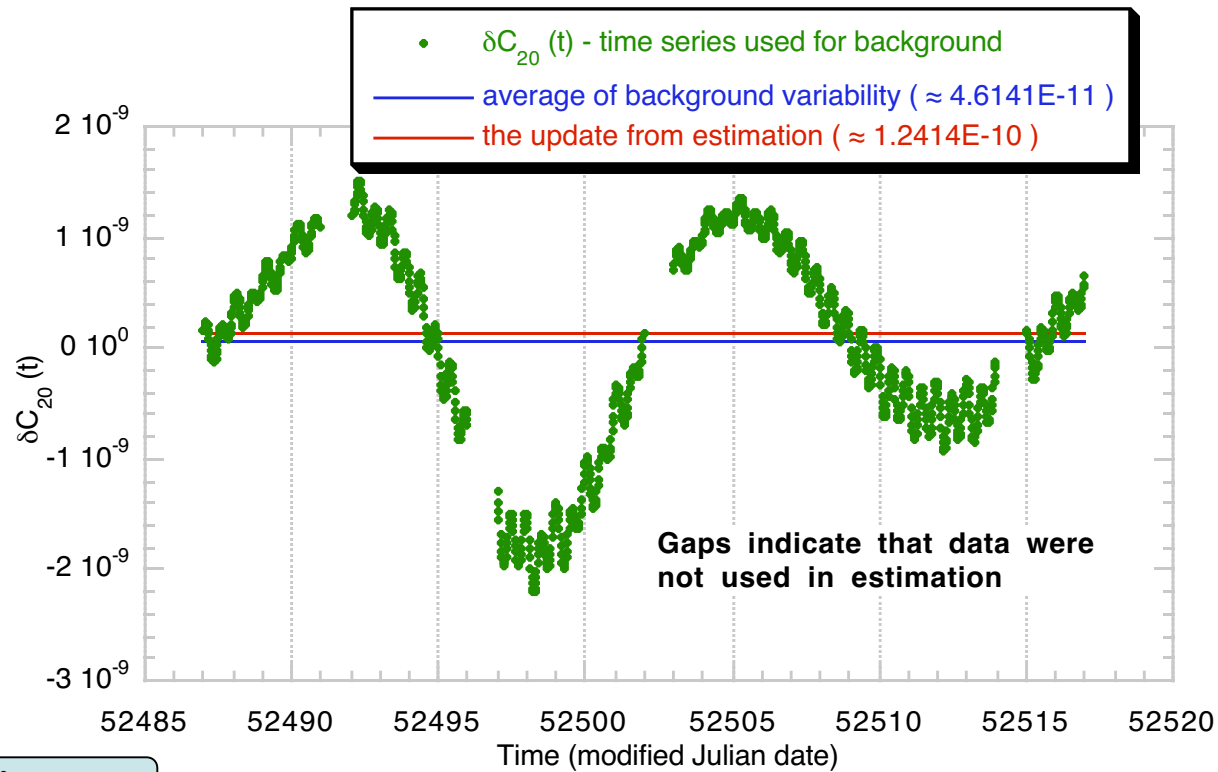

Level-2 Product Nomenclature

PID-2_YYYYDOY-YYYYDOY_ddddd_ssss_RL

- *PID* is a 3-character string (more on this...)
- *YYYYDOY-YYYYDOY* denotes dates of GRACE data used in the solution
 - *Complete listing of dates used in the solution is contained as comments within the product files*
- *dddd* is an institution specific string
- *sss* = GRACE
- *RL* is a 2 digit release number

The name of the file containing this product is this string - along with an archive specific file extension (or prefix)

Level-2 Product ID

- 1st Character is used to distinguish geopotential coefficients & covariances matrix.
- 2nd Character denotes the *kind* of the product
 - GRACE estimates
 - Background model
 - time series
 - averages over specified data span
- 3rd Character specifies the component
- Complete list & description in *L-2 User Handbook* and in *Product Specification Document*

Information in a Product File

- Header records
 - Dates or date-ranges in the solution span
 - GM & a_e - to be used for evaluation of the potential
 - Normalization indicator
 - Permanent tide convention
- The geopotential coefficient records
 - coefficient values
 - associated epochs or sub-spans
 - coefficients may appear multiple times within each product, but with different sub-spans within the larger span of the solution.
 - the coefficient error standard deviations

Jet Propulsion Laboratory
Physical Oceanography
Distributed Active Archive Center
(PO.DAAC)

Chris Finch, Kelley Case

8-10 October 2003

GRACE Science Team Meeting
Center for Space Research, Austin, TX

PO.DAAC Overview

- Physical Oceanography Distributed Active Archive Center
 - NASA EOSDIS Physical Oceanography Component
 - Partnership between JPL and Raytheon
 - 14 Management, Science, and System and Data Engineering Staff at JPL
 - 15 Operations, Sustaining Eng., and User Services staff at Raytheon
 - The goal of the PO.DAAC is to make available to the oceanographic, geophysical, and interdisciplinary science communities physical information about the oceans in easily usable form. This goal will be accomplished through the acquisition, processing, archiving, and distribution of remote sensing data and through the provision of higher-level data products to the scientific community.
-

Mission Support Services

- ◆ PROVIDE PROJECT-LEVEL DOCUMENTATION: IPA, ICD, DMP
- ◆ SUPPORT GROUND DATA SYSTEM PLANNING AND INTERFACES
- ◆ COORDINATE SCHEDULES AND ACTIVITIES WITH FLIGHT PROJECTS
- ◆ PARTICIPATE IN FLIGHT PROJECT CAL/VAL AND QA PROCESSES
- ◆ HOST INTERNAL WEB / FTP SITES FOR CAL/VAL AND SWT ACTIVITIES
- ◆ COORDINATE OUTREACH ACTIVITIES WITH FLIGHT PROJECTS
- ◆ PROVIDE DATA QA, DOCUMENTATION AND READ SOFTWARE: USER'S GUIDE, DIF

- ◆ INGEST AND ARCHIVE LEVEL 0, 1, ANCILLARY DATA
- ◆ INGEST, ARCHIVE AND DISTRIBUTE LEVEL 2, 3 DATA
- ◆ INGEST, ARCHIVE AND DISTRIBUTE PI DATA PRODUCTS
- ◆ INGEST AND DISTRIBUTE OSDR (3-HR) AND IGDR (1-DAY) DATA IN NEAR REAL TIME

- ◆ DESIGN, PRODUCE, ARCHIVE AND DISTRIBUTE LEVEL 3, 4 VALUE-ADDED PRODUCTS
- ◆ INTEGRATION OF DATA FROM MULTIPLE MISSIONS FOR MULTI-DECADAL TIME SERIES
- ◆ PROVIDE DATA BROWSE AND SUBSETTING ON THE WEB
- ◆ PROVIDE DATA DISCOVERY AND ACCESS SERVICES
- ◆ PROVIDE USER SUPPORT SERVICES
- ◆ SUPPORT OPERATIONAL USERS WITH HIGH RELIABILITY NEAR REAL TIME SYSTEM
- ◆ COORDINATE WITH OTHER DATA CENTERS TO MIRROR DATA PRODUCTS
- ◆ ARCHIVE END OF MISSION DATA, SOFTWARE AND RELATED DOCUMENTS

PO.DAAC GRACE Data Flow

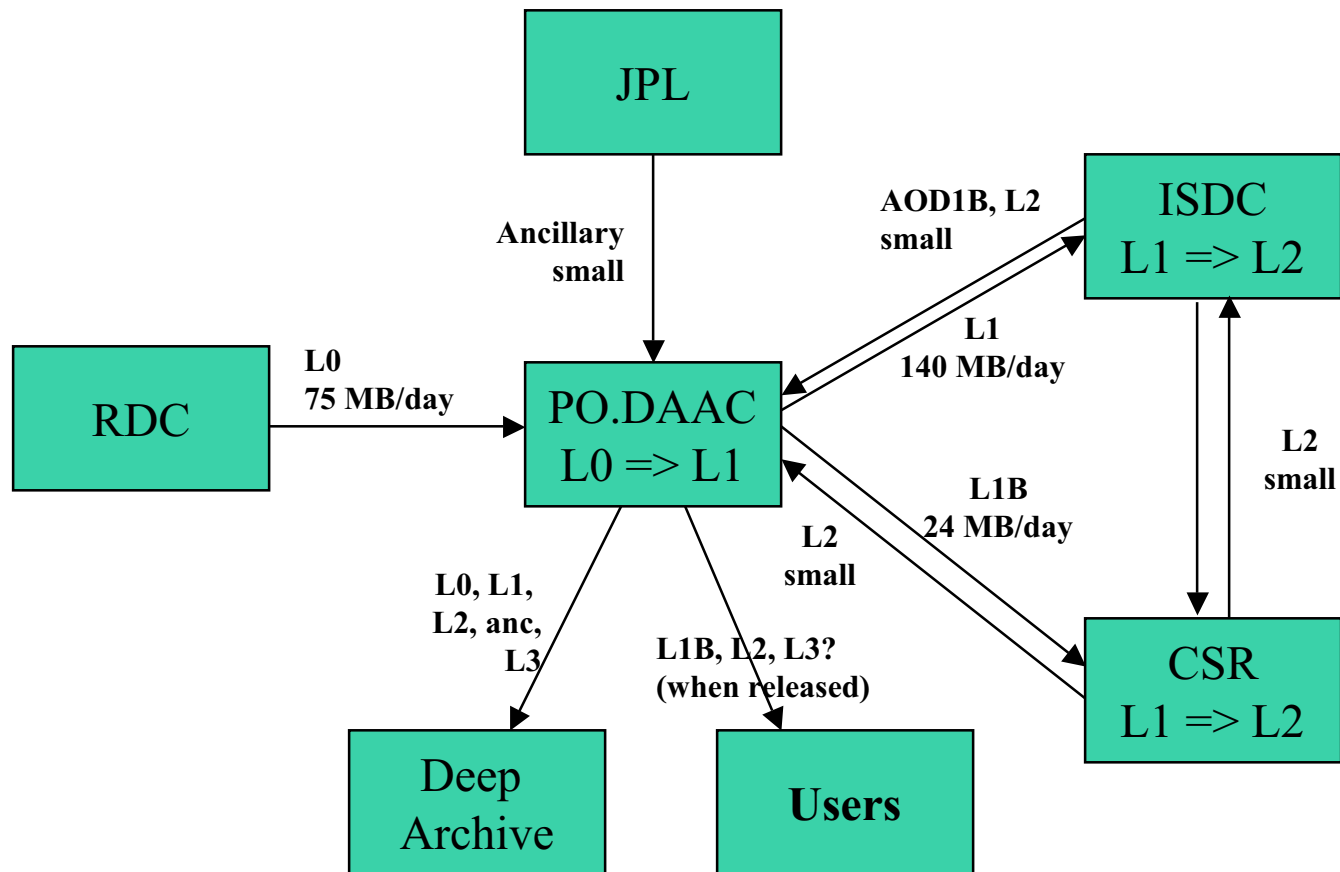

PO.DAAC GRACE Status

- Operational processing of L0 data to L1B
 - Able to automatically archive and distribute data
 - Distribution not yet data driven
 - Draft “GRACE L1B Data Product Handbook”, JPL D-22027
 - CSR L1 distribution working well, fine tuning.
 - GFZ/ISDC Interfaces still under way
 - L0 harmonization on target
 - L1 changing delivery to include report files, fine tuning
 - AOD1B now changing to come via ISDC
 - Ready to start working L2 interfaces
 - Prepare web, documentation and ftp site for general availability
-

GRACE Product Distribution

Level	Volume (gz) (MB/Day)	Latency	Packaging
L0	75	minutes	N/A
L1A	140	2 weeks	daily tar files
L1B	25	2 weeks	daily tar files
L2	small	2 months	monthly files
L3 (?)	small	tbd	monthly maps

Proposed FTP Site Map

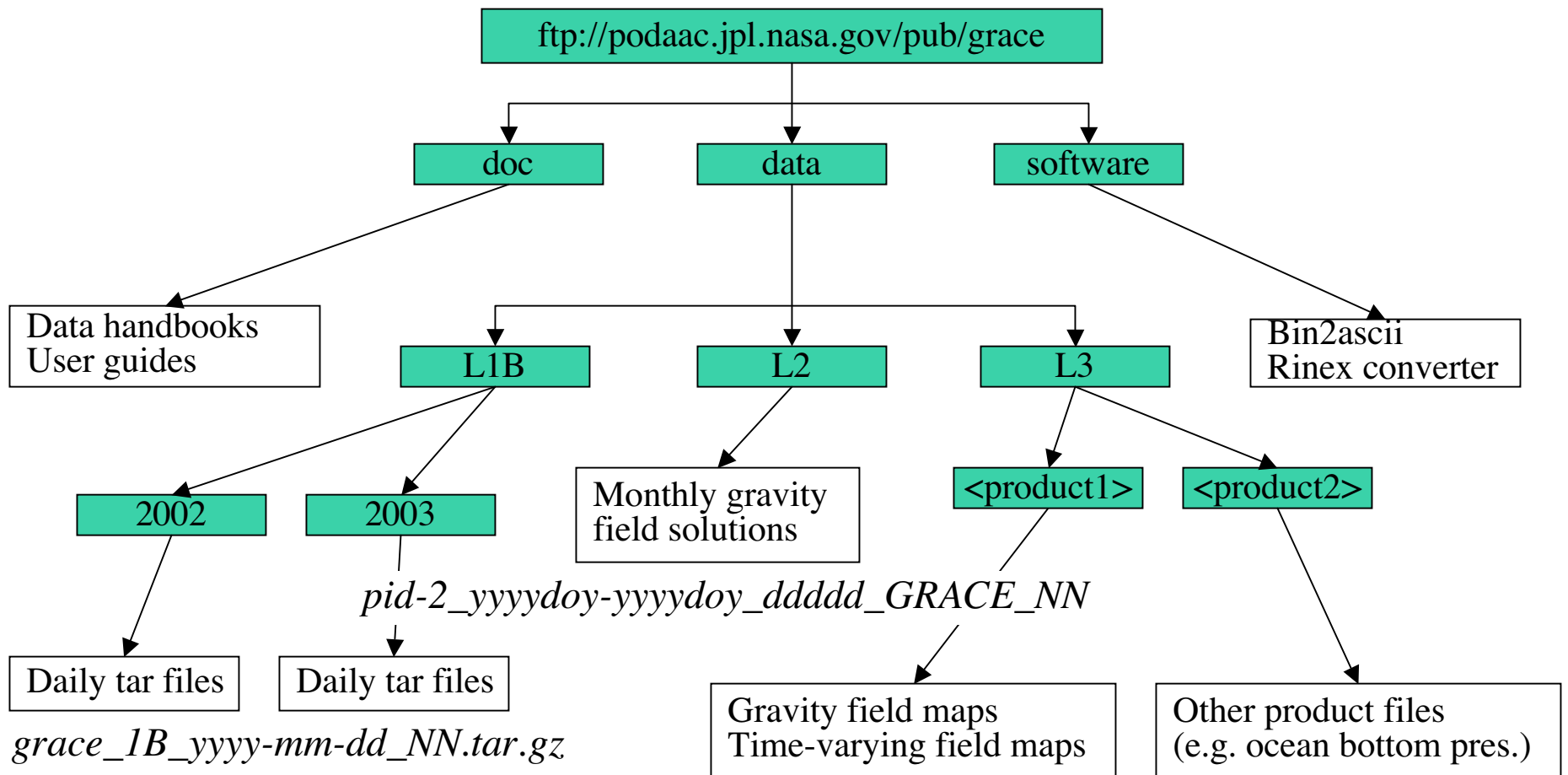

Example GRACE L1B Header

```
PRODUCER AGENCY           : NASA
PRODUCER INSTITUTION      : JPL
FILE TYPE ipKBR1BF        : 7
FILE FORMAT 0=BINARY 1=ASCII : 0
NUMBER OF HEADER RECORDS  : 47
SOFTWARE VERSION          : @(#) KBR_compress.c      1.69 05/29/03
SOFTWARE LINK TIME        : @(#) 2003-09-11 14:15:51 glk j2
REFERENCE DOCUMENTATION   : GRACE Level 1 Software Handbook
SATELLITE NAME            : GRACE A+B
SENSOR NAME                : IPU 1+1
TIME EPOCH (GPS TIME)     : 2000-01-01 12:00:00
TIME FIRST OBS(SEC PAST EPOCH): 107438400.000000 (2003-05-29 00:00:00.00)
TIME LAST OBS(SEC PAST EPOCH) : 107524795.000000 (2003-05-29 23:59:55.00)
NUMBER OF DATA RECORDS   : 17261
PRODUCT CREATE START TIME(UTC): 2003-09-17 11:07:02 by l0tol1
PRODUCT CREATE END TIME(UTC) : 2003-09-17 11:07:12 by l0tol1
FILESIZE (BYTES)          : 1609161
FILENAME                   : KBR1B_2003-05-29_X_00.dat
PROCESS LEVEL (1A OR 1B)  : 1B
INPUT FILE NAME            : KBR1A_A_0<-KBR1A_2003-05-29_A_00.dat
INPUT FILE TIME TAG (UTC) : KBR1A_A_0<-2003-09-04 03:59:17 by l0tol1
```

PO.DAAC Contact Information

- WWW <http://podaac.jpl.nasa.gov>
 - GRACE page, <http://podaac.jpl.nasa.gov/grace> available prior to data release
 - Email
 - podaac@podaac.jpl.nasa.gov for general questions
 - grace@podaac.jpl.nasa.gov for technical questions
 - Contact Kelley Case
 - FTP
 - podaac.jpl.nasa.gov
 - pub/grace directory
-



GRACE ISDC and Interfaces with PO.DAAC

Frank Flechtner, Christian Ackermann
Bernd Ritschel, Andrea Schmidt

GeoForschungsZentrum Potsdam (GFZ)
Department 1 “Geodesy & Remote Sensing”

GRACE Science Team Meeting
Austin, TX, October 8-10, 2003



isdc.gfz-potsdam.de/champ
isdc.gfz-potsdam.de/grace

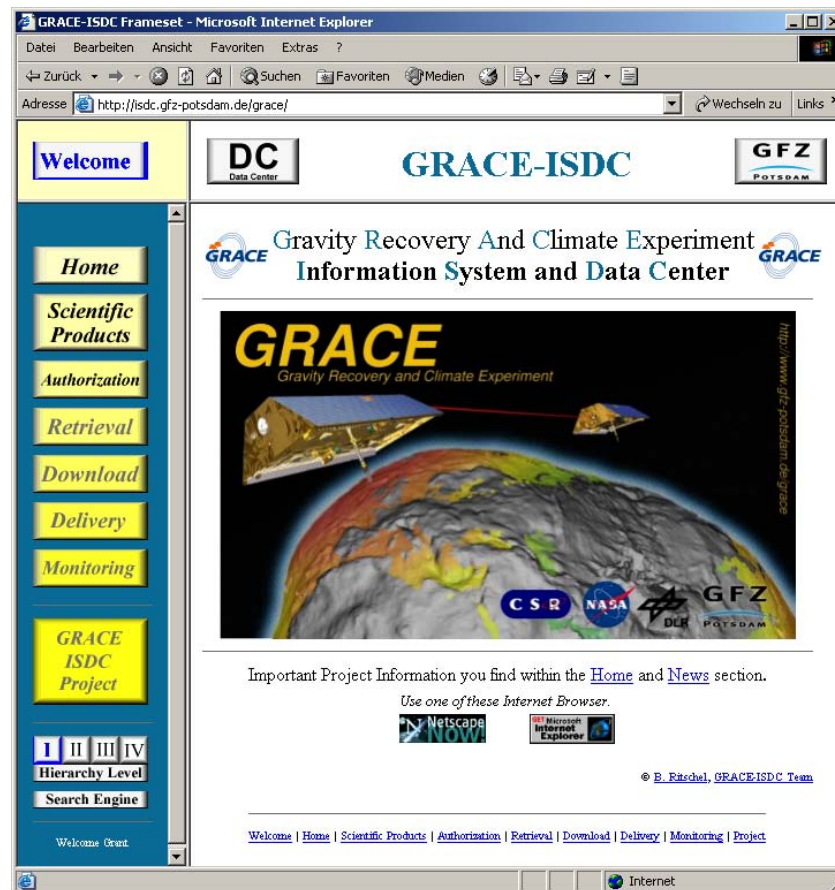
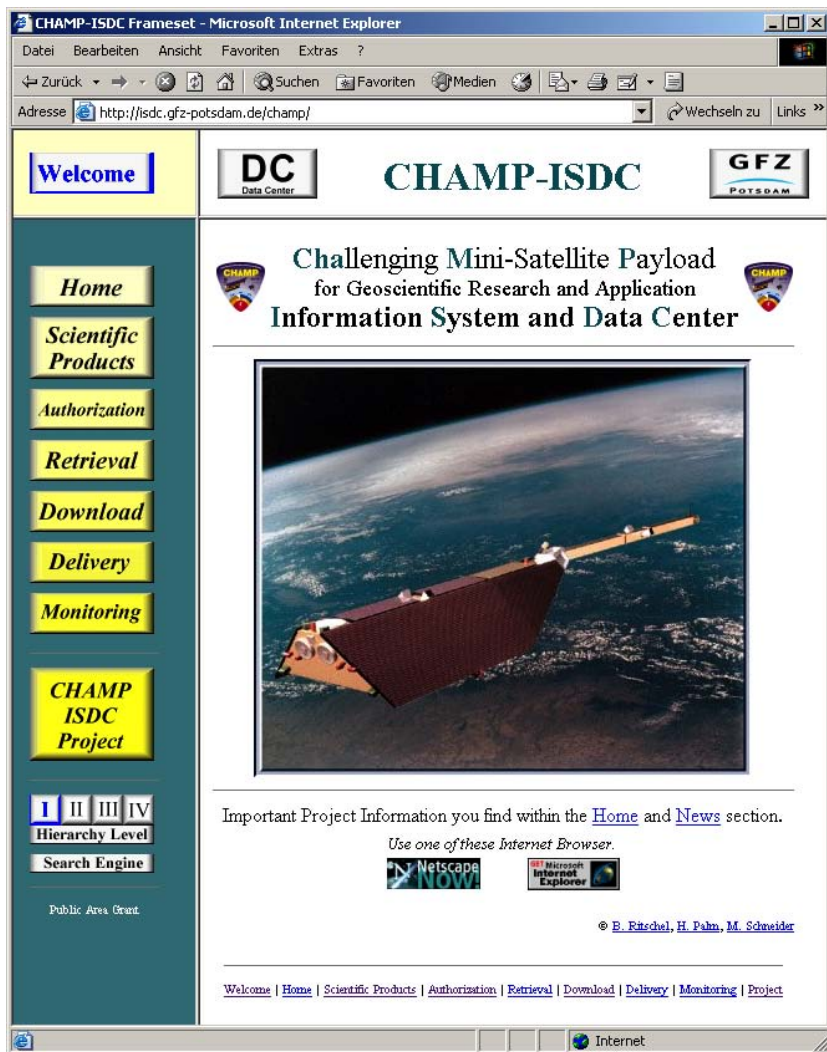

CHAMP and GRACE ISDC (Integrated System and Data Center)

- management of all scientific products
- operation period designed to cover the whole mission lifetime and beyond
- requests for Ø 2,500 products (5 GB) per day
- online product archive (OPA) (3.5 TB, 3 raid systems Level 5 + hot-spare hard disc)
- product backup archive (HSM) (10 TB, Hierarchical Storage Management, tapes, optical discs)
- CHAMP user groups: international 252 (29 countries), national 54
- catalog system for product retrieval
- data visualization

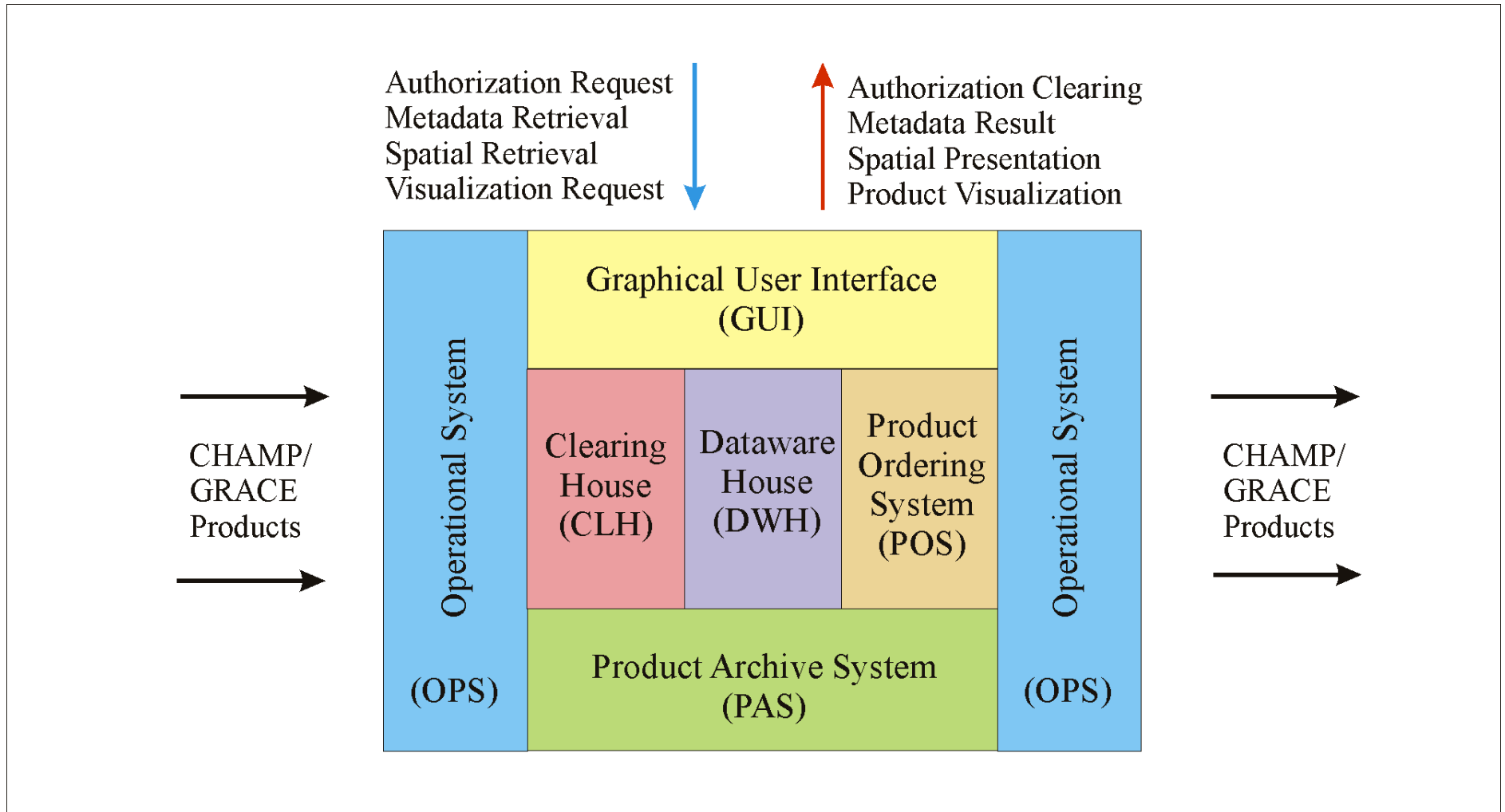

ISDC scientific product = data plus metadata

metadata follow extended DIF (**D**irectory **I**nterchange **F**ormat) standard (<http://gcmd.gsfc.nasa.gov/User/difguide/whatisadif.html>)

metadata contain information on

- originator, investigator, technical contact (name, address, mail, phone, ...)
- title, description of product
- publication date, release
- parameters (start and end date, spatial coverage/resolution, software, size, ...)
- keywords
- other

- registration by the user necessary (<http://isdc.gfz-potsdam.de/grace>)
- products can be requested by
 - 1) Download Batch Mode via ASCII File-interface
 - 2) Product Retrieval via WWW based GUI
 - 3) Direct Delivery Mode for time critical products
- products are provided by the Product Archive System and stored in user own FTP directory (limitations: # files, volume, automatic delete after 1 week)
- product transfer monitoring via GUI
- product placing success or error message or file:
 - Product Retrieval: Message “product name not available”
 - Batch Mode: `username_XXXXXXXXXX.err`

- Example for ASCII batch mode product request list (prl) file to be provided in user own FTP directory (simple, knowledge of exact product nomenclature necessary, prl filename convention)
- Name: **username**_xxxxxxxxxxxx.prl
- Content:

deliver: dat

GA-OG-1B-GPSDAT+JPL-GPS1B_2003-10-21_A_00

GA-OG-1B-ACCDAT+JPL-ACC1B_2003-09-01_A_00

GX-OG-1B-ATMOCN+GFZ-AOD1B_2003-08-30_X_01

ISDC prefix + production center - orig. L0-L2 filename

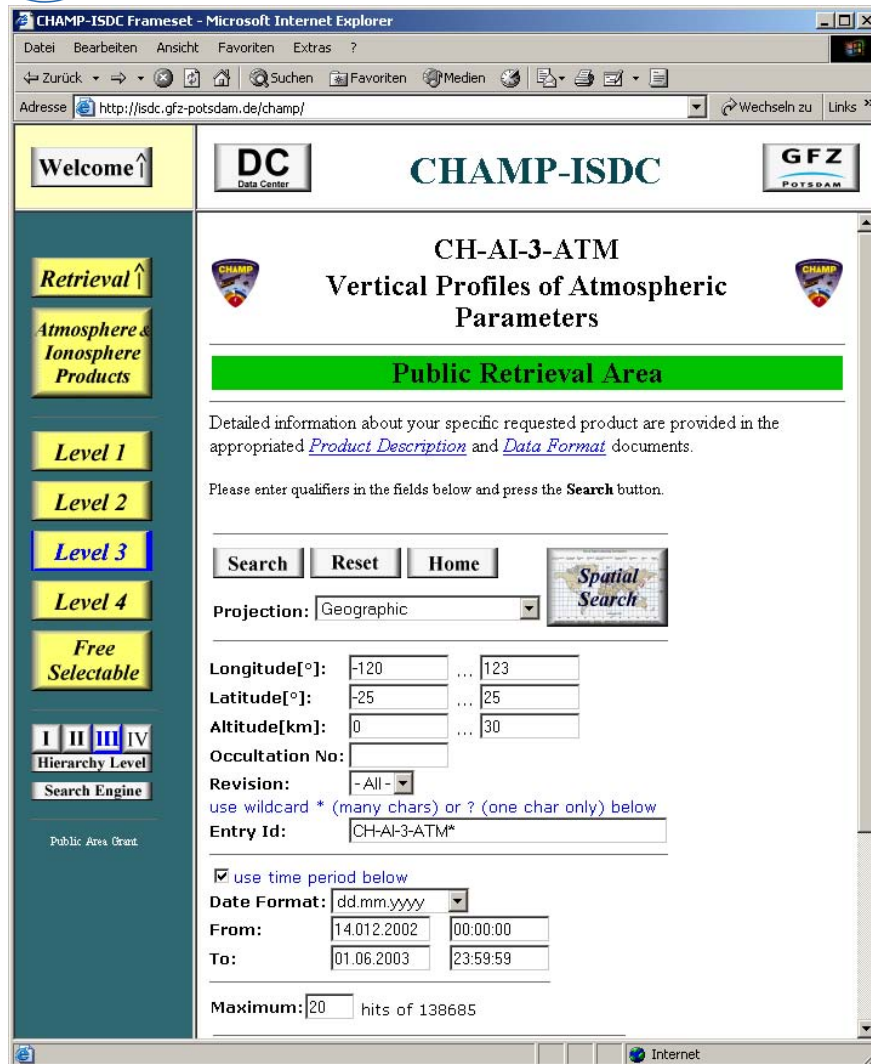

CHAMP-ISDC Frameset - Microsoft Internet Explorer

Adresse: <http://isdc.gfz-potsdam.de/champ/>

Welcome ↑

DC Data Center

CHAMP-ISDC

GFZ POTSDAM

Retrieval ↑

Atmosphere & Ionosphere Products

Level 1

Level 2

Level 3

Level 4

Free Selectable

I II III IV Hierarchy Level

Search Engine

Public Area Grant

CH-AI-3-ATM

Vertical Profiles of Atmospheric Parameters

Public Retrieval Area

Detailed information about your specific requested product are provided in the appropriated [Product Description](#) and [Data Format](#) documents.

Please enter qualifiers in the fields below and press the **Search** button.

Search Reset Home

Projection: Geographic

Longitude[°]: -120 ... 123

Latitude[°]: -25 ... 25

Altitude[km]: 0 ... 30

Occultation No:

Revision: -All-

use wildcard * (many chars) or ? (one char only) below

Entry Id: CH-AI-3-ATM*

use time period below

Date Format: dd.mm.yyyy

From: 14.012.2002 00:00:00

To: 01.06.2003 23:59:59

Maximum: 20 hits of 138685

ATM Product Retrieval

- Space Frame
- Time Frame
- Occultation No.
- Revision No.
- Entry-Identifier
- Spatial Search

The screenshot shows the CHAMP-ISDC website interface. The main content area displays 'CH-AI-3-ATM Vertical Profiles of Atmospheric Parameters' under a 'Public Retrieval Area'. A table lists 18 data entries with columns for Entry Id, Start Longitude, End Longitude, Start Latitude, End Latitude, Start Altitude, End Altitude, and Elevation. Each entry includes a checkbox and a 'Full' link. To the right of the table, a list of links for 'DIF', 'XML', and 'Pic' is provided for each entry, along with a 'DIF Data Product' link.

Full	Entry Id	Start Longitude[°]	End Longitude[°]	Start Latitude[°]	End Latitude[°]	Start Altitude[km]	End Altitude[km]	Elevation
<input type="checkbox"/>	+2002_348_00_0003_tidb_004	102.68	103.69	0.19	1.22	116.69	4.60	
<input type="checkbox"/>	+2002_348_00_0005_hrao_004	85.84	85.36	20.10	20.65	118.58	6.80	
<input type="checkbox"/>	+2002_348_00_0011_kokb_004	-110.44	-111.41	8.70	7.17	133.68	7.20	
<input type="checkbox"/>	+2002_348_01_0021_tidb_004	80.20	81.06	-13.10	-12.03	50.16	2.40	
<input type="checkbox"/>	+2002_348_01_0022_hrao_004	54.78	53.15	9.68	12.39	143.37	3.20	
<input type="checkbox"/>	+2002_348_01_0023_hrao_004	68.28	68.35	23.03	23.64	118.19	1.60	
<input type="checkbox"/>	+2002_348_03_0039_hrao_004	37.63	36.85	22.69	23.74	123.97	3.40	
<input type="checkbox"/>	+2002_348_04_0059_hrao_004	19.05	18.85	21.06	21.52	123.52	6.00	
<input type="checkbox"/>	+2002_348_09_0115_lpgm_004	-35.94	-34.74	18.92	19.86	122.72	3.40	
<input type="checkbox"/>	+2002_348_09_0116_lpgm_004	-47.32	-47.18	23.21	23.75	121.67	4.20	
<input type="checkbox"/>	+2002_348_10_0124_mizu_004	111.90	111.12	-18.82	-19.59	89.30	3.80	
<input type="checkbox"/>	+2002_348_12_0147_lpgm_004	-96.42	-96.54	22.41	23.09	128.56	2.40	
<input type="checkbox"/>	+2002_348_13_0151_madr_004	64.22	63.31	-6.39	-7.63	124.68	6.80	
<input type="checkbox"/>	+2002_348_13_0152_potm_004	81.83	82.54	-13.74	-14.25	109.96	7.80	
<input type="checkbox"/>	+2002_348_14_0171_nya2_004	66.24	67.39	22.77	21.02	127.59	6.40	
<input type="checkbox"/>	+2002_348_14_0172_madr_004	36.88	35.34	-1.78	-4.62	138.43	4.80	
<input type="checkbox"/>	+2002_348_19_0219_potm_004	-5.61	-4.53	14.12	12.76	133.17	6.20	
<input type="checkbox"/>	+2002_348_19_0220_madr_004	-7.62	-6.72	6.90	6.00	124.15	7.40	

- DIF/XML-Link
- Product Access

Visualization of selected GRACE products planned (as for CHAMP)

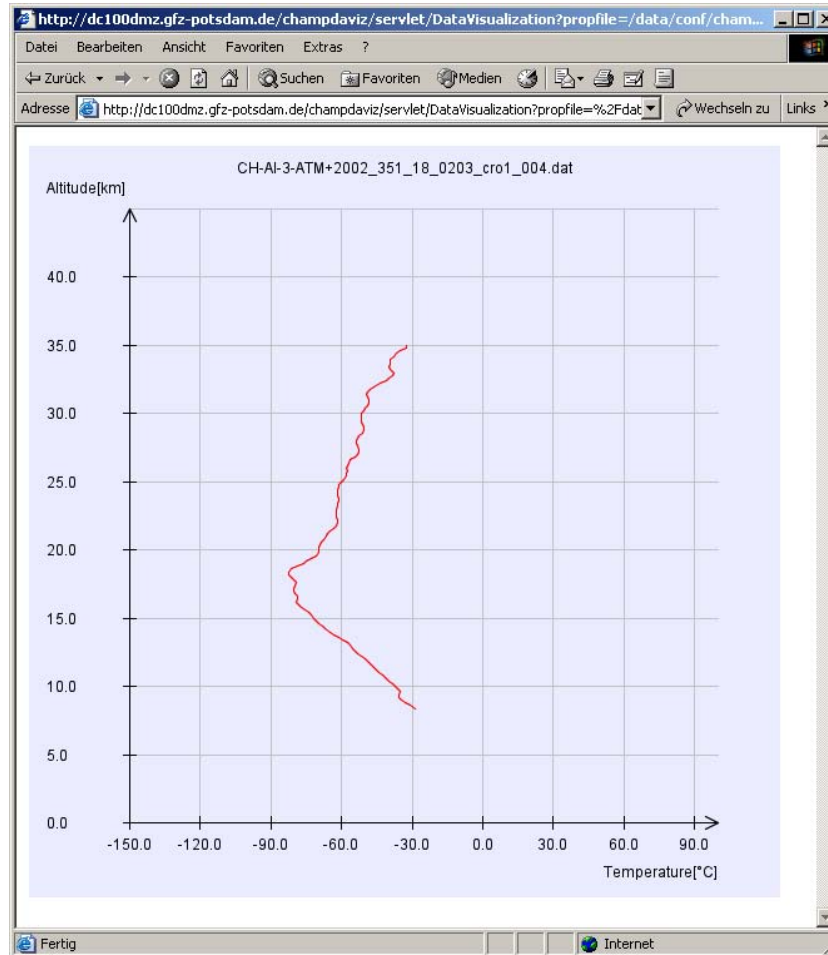

Product Visualization

- Atmosphere Occultations
 - Temperature Profile
 - Water Vapor Profile
- Ionosphere Occultations
 - Electron Density Profile

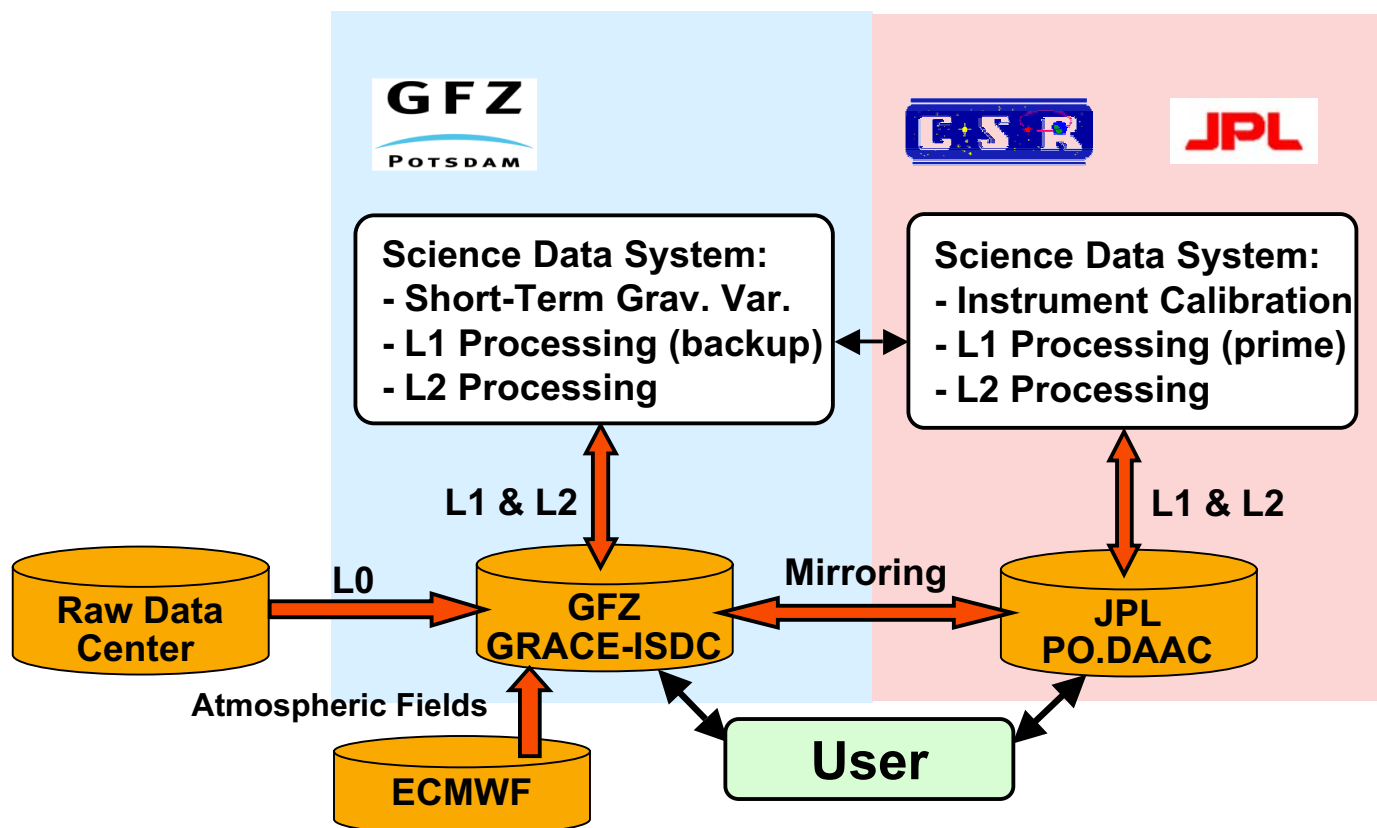



GRACE ISDC: Harmonization with PO.DAAC



Goal: guarantee same data base and access in ISDC and PO.DAAC

- Procedure and schedule for L0 harmonization (DMP, R/T, LOG) based on harmonization files (LHF, tables containing filenames and sizes) agreed, tests already started (until day 194, 2003).
- Remaining difference mostly from beginning of the mission (prior day 105/2002) which is due to problems with RDC product delivery (unrealistic additional files at PO.DAAC).
- Procedure will be iterated and automated for future harmonization.





PO.DAAC L1 Product Delivery to ISDC



- Reprocessed L1A and L1B products (L1 data plus DIF-files) have been provided by PO.DAAC to ISDC FTP account
- Preliminary results (status September 30):
 - 13 months (04,05,08-12 2002 and 02-04, 06-08 2003) archived (17667 files (26 GB) in total or 45 files (65 MB) per day)
 - ISDC “DIF checker” found no problems
 - 99.98% successfully archived. 300 files (115 dif, 215 dat) empty and have to be provided again (e-mail notification to PO.DAAC, shall be automatized (weekly harmonization using LHF))
- Next steps:
 - Updated DIF generation software for non-standard ECI1A, TDP1A, TDP1B products (no L1 header) and L1 report files provided to PO.DAAC on Oct. 1
 - All L1 difs, report files and ECI1A, TDP1A, TDP1B have to be provided again
 - md5 checksum could be included in protocol and dif for safety reasons



- GRACE ISDC was developed on the basis of CHAMP ISDC and is presently tested for L0 raw, L1 instrument and AOD1B data.
 - L0 product harmonization was successfully performed. Minor discrepancies have to be analyzed, missing files exchanged. Concept to minimize discrepancies and to automate harmonization elaborated.
 - L1 delivery to ISDC nearly perfect! Remaining issues almost solved.
 - As soon as tests are finished, PI and Co-PI may release access to selected products.
 - Harmonization concept, data access procedures etc. have to be integrated in ISDC - PO.DAAC ICD.
- => GRACE ISDC and interface to PO.DAAC will be fully tested and operationally until end of 2003.

L1 KBR Measurement and Time Calibration

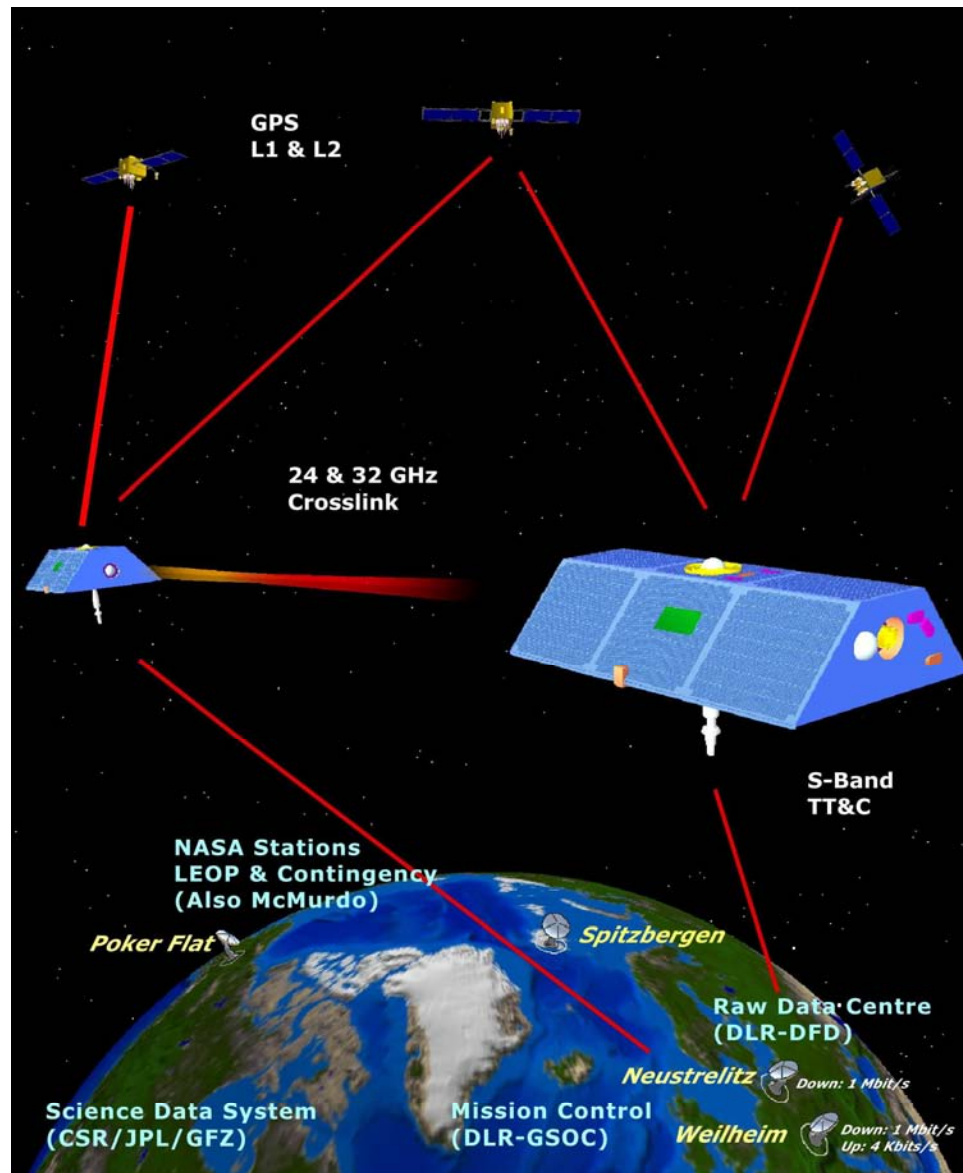

Willy Bertiger

Charles Dunn
Gerhard Kruizinga
Sumita Nandi
Larry Romans
Michael Watkins
Sien Wu
Dah-Ning Yuan

Srinivas Bettadpur
JR Kim

K-Band Ranging System

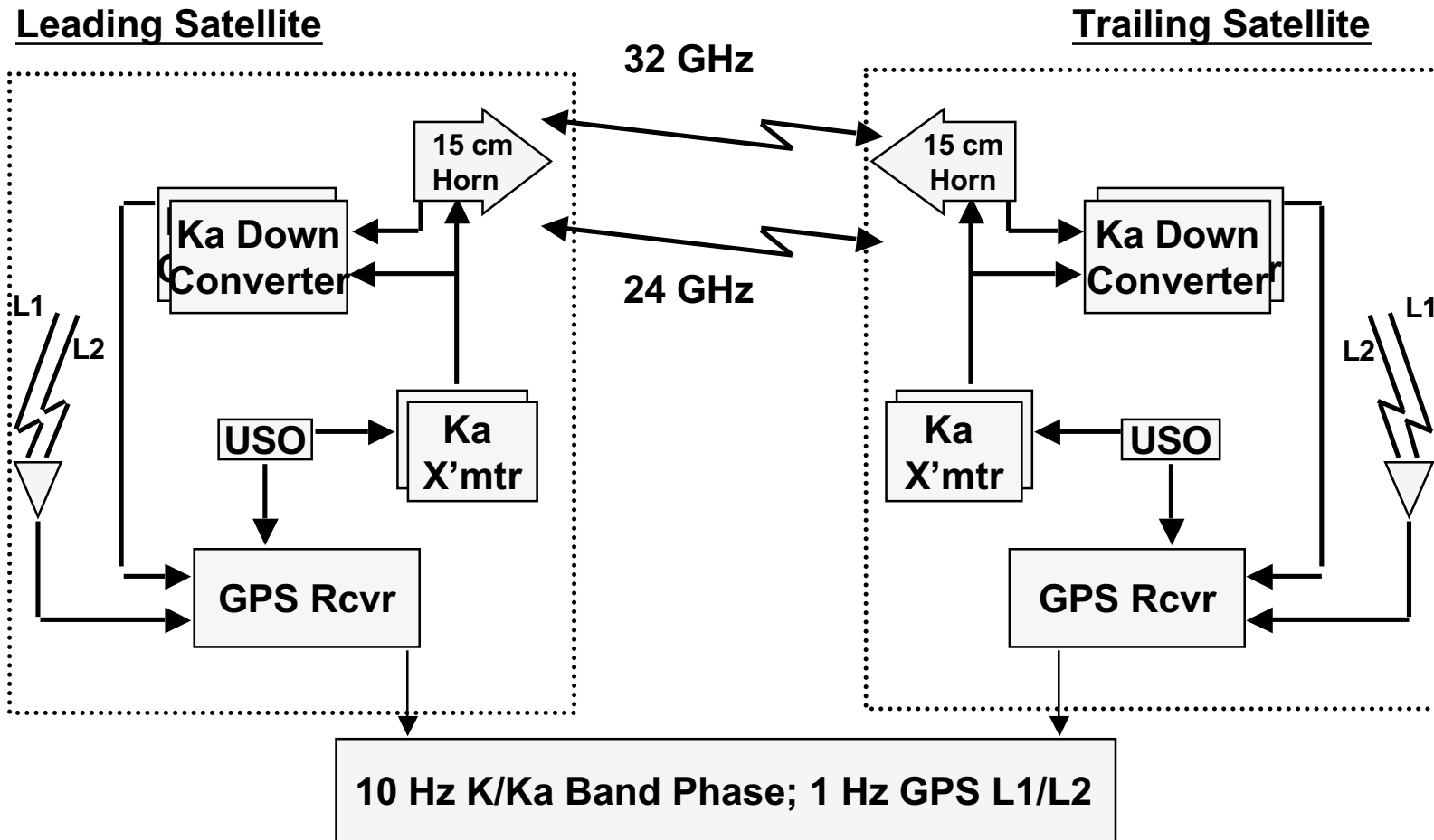

What's dual 1-Way, KBR

$$\phi_A = C_A(t_r) - C_B(t_t) = R + C_A^e(t_r) - C_B^e(t_t)$$

$$\phi_B = C_B(t_r) - C_A(t_t) = R + C_B^e(t_r) - C_A^e(t_t)$$

$$\phi_A + \phi_B = 2R + \boxed{\begin{array}{l} C_A^e(t_r) - C_A^e(t_t) \\ + C_B^e(t_r) - C_B^e(t_t) \end{array}}$$

GPS Calibration Use

- Time synchronization
 - 0.1 ns relative time
 - .16 ns ~ 0.5 micron due to freq. Offset(500 Khz)

- Orbit determination
- Phase Center to CG Corrections
- Light Time Corrections
- Freq. Error

$$c\tau \delta f / f$$

POD Scheme

- 5 Minute GPS Data
- 1 Spacecraft at a time
- Dynamics
 - GGMOC1
 - DTM94
 - Macro Model
 - Solar Radiation, Albedo, Tides
 - Attitude Control
- Reduced Dynamics
 - 50, 100, 300 nm/s² ;
 - 15 min. time constant
 - More than we need
but sins are forgiven
- FLINN Orbits and Clocks
- IERS 2000, Tech. Note 21
- 30 Hour Arcs
- **No Accelerometer** data yet
- Star camera attitude

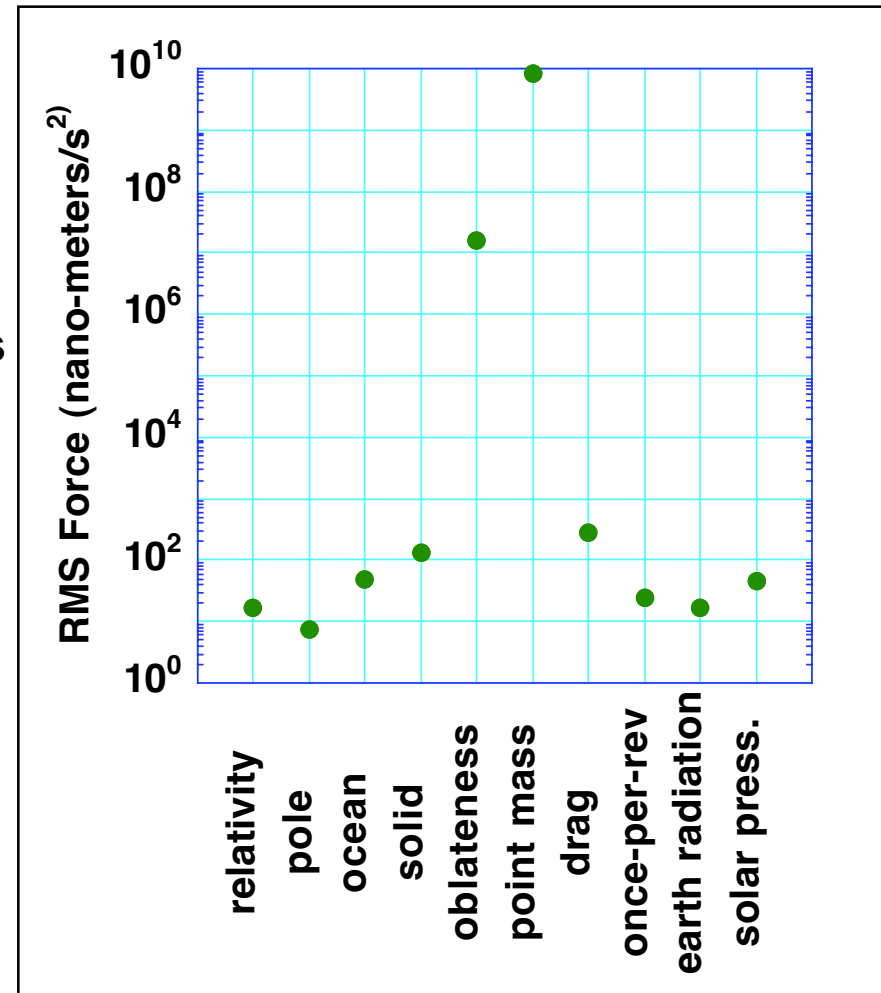

GPS Orbit/Clock Determination Fit Residuals

Histogram GPS Phase Residuals
2002-03-19 to 2003-09-19

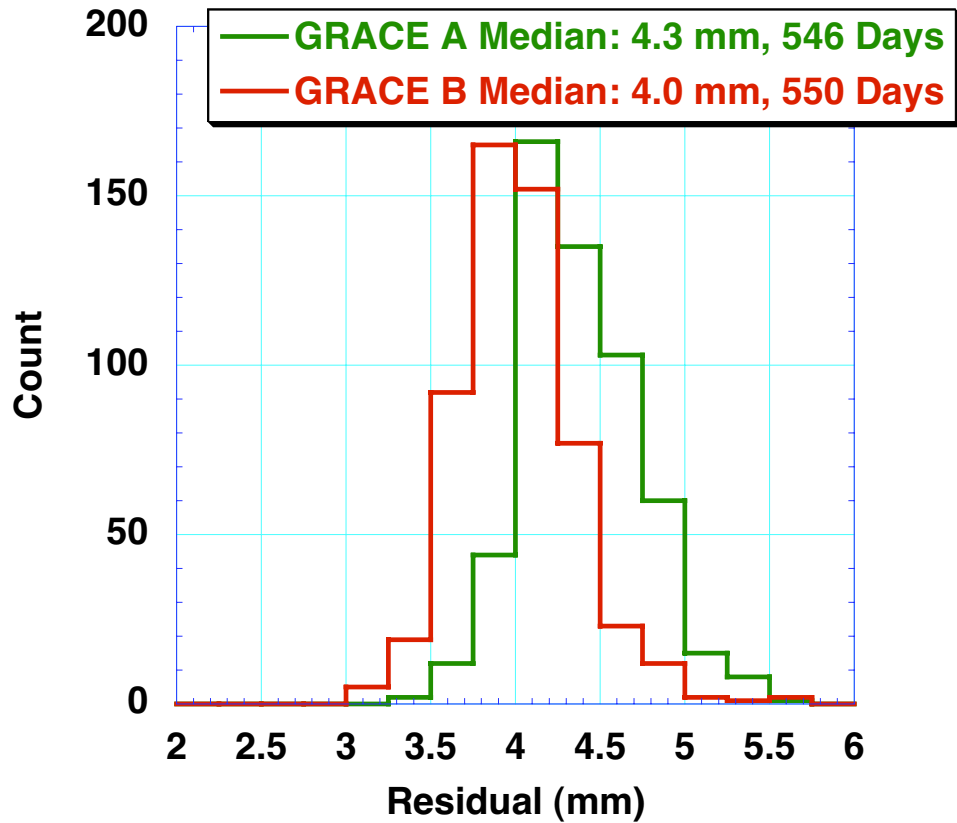

Histogram GPS Range Residuals
2002-03-19 to 2003-09-19

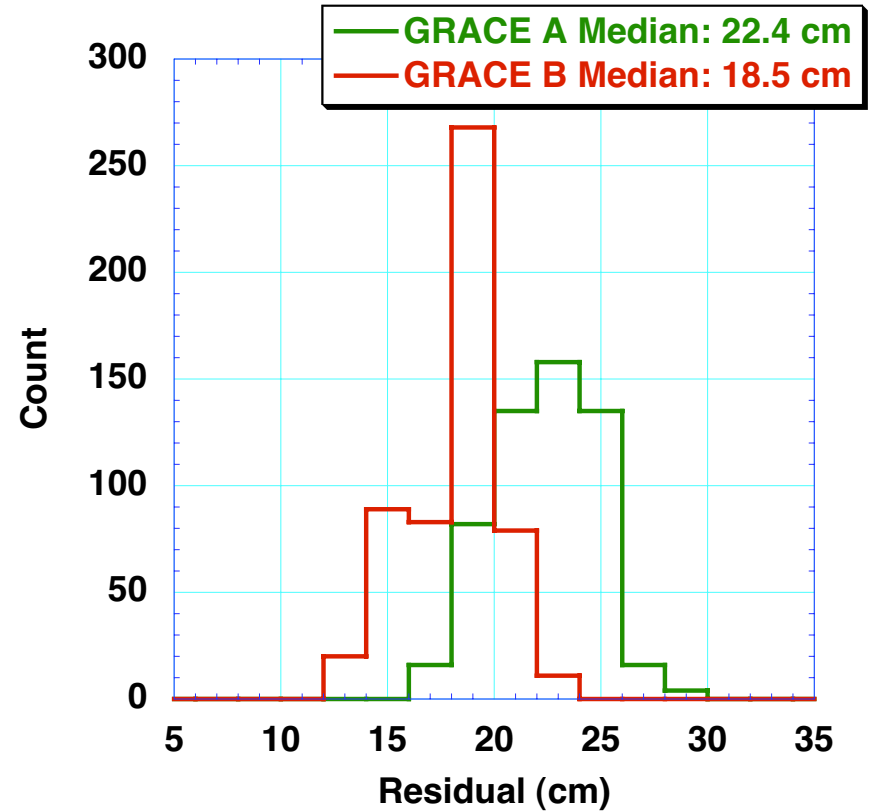

Orbit Overlap Statistics

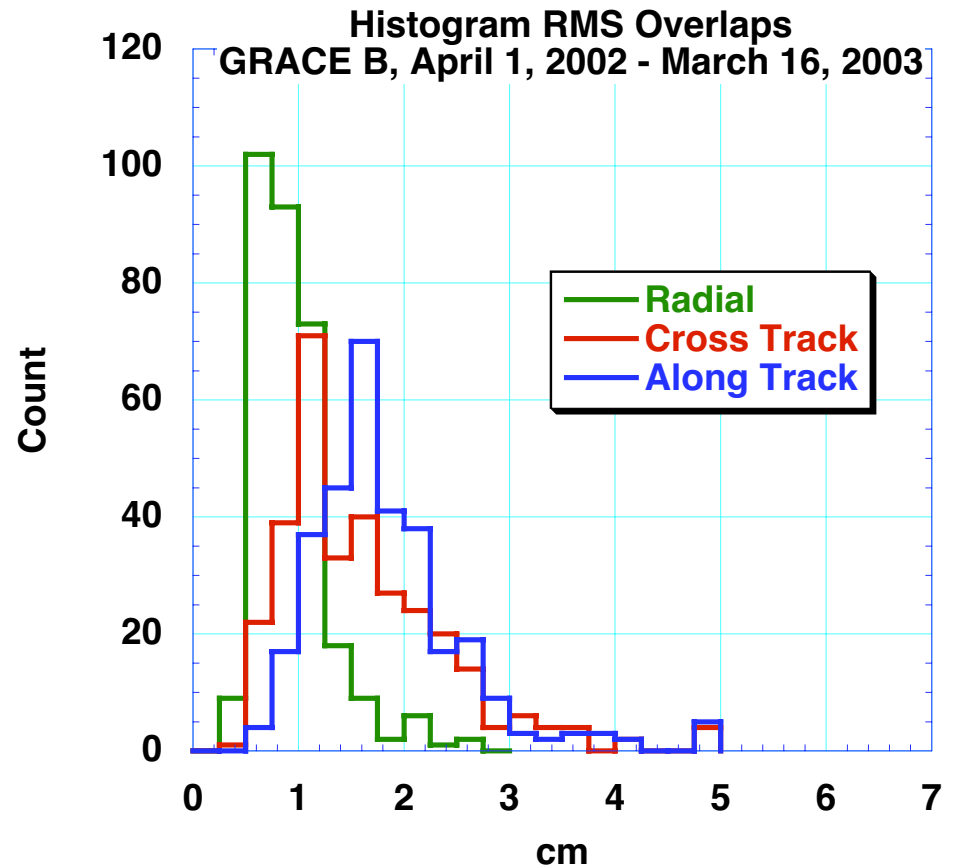
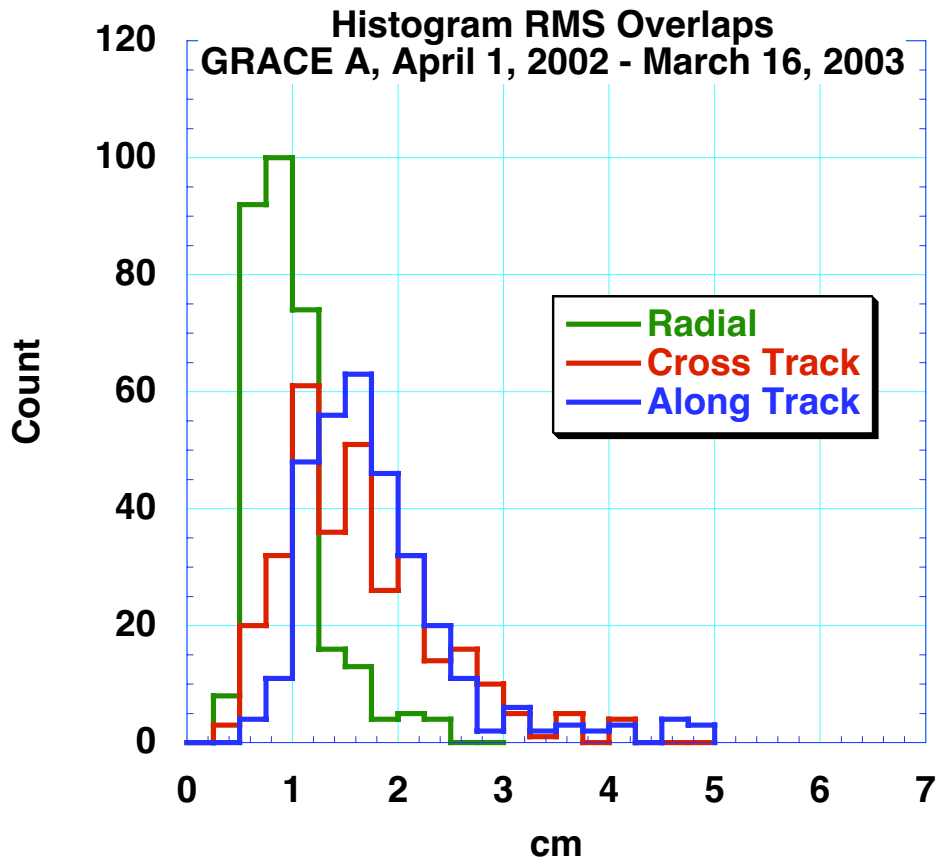

Medians With 3-sigma Edit

A: 0.9 1.5 1.6 cm

B: 0.8 1.4 1.6 cm

Daily RMS (KBR Range – GPS – Bias)

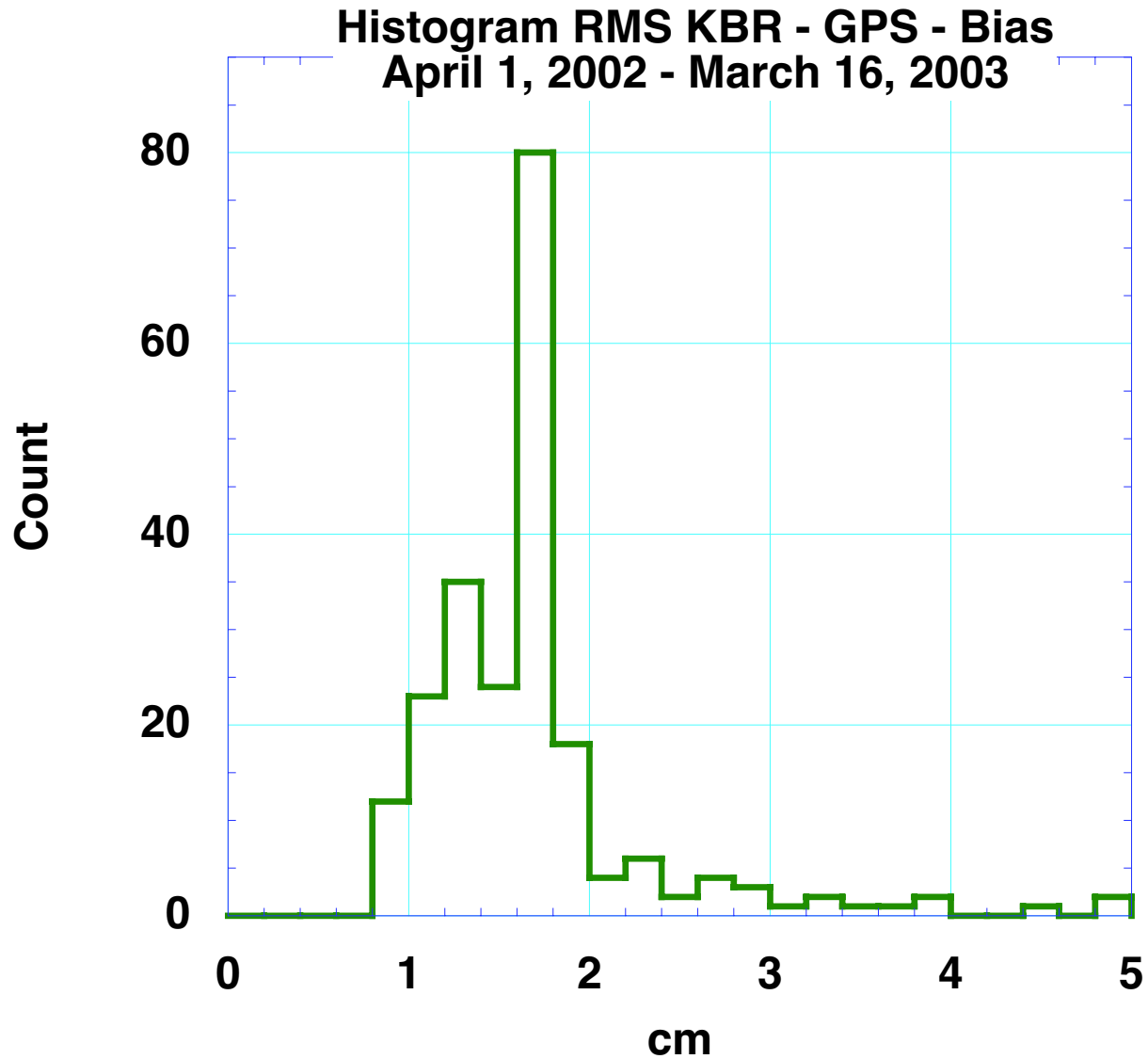

Median: 1.6 cm

Clock Overlap Tests

$$(A - B)_{\text{prev arc}} - (A - B)_{\text{cur arc}}$$

Histogram
RMS A Clock Overlap - B Clock Overlap
April 1, 2002 - March 16, 2003

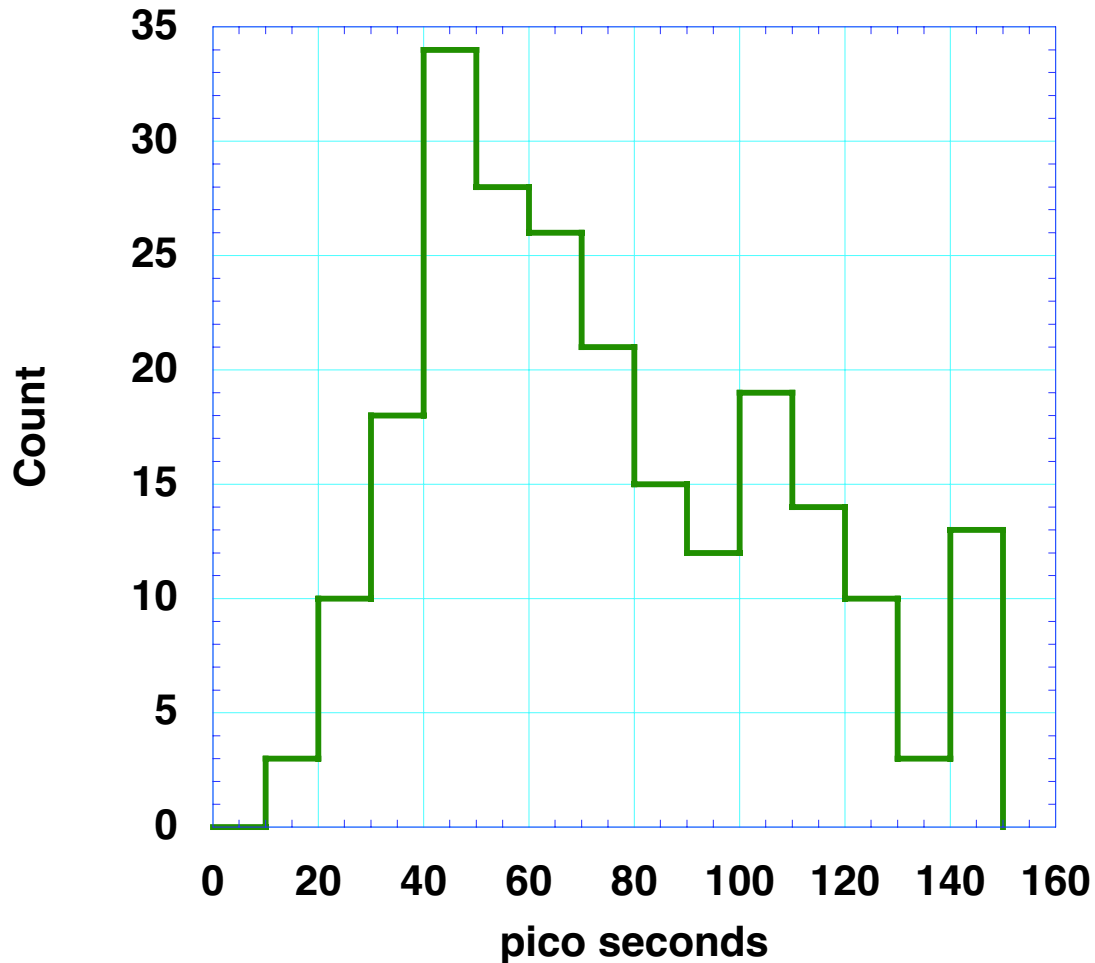

**Median: 68 ps =
2 cm**

Clock Overlap Tests

$$(A - B)_{\text{prev_arc}} - (A - B)_{\text{cur_arc}}$$

Histogram Sept. 2003 Reprocessing
RMS A Clock Overlap - B Clock Overlap
April 1, 2002 - September 12, 2003

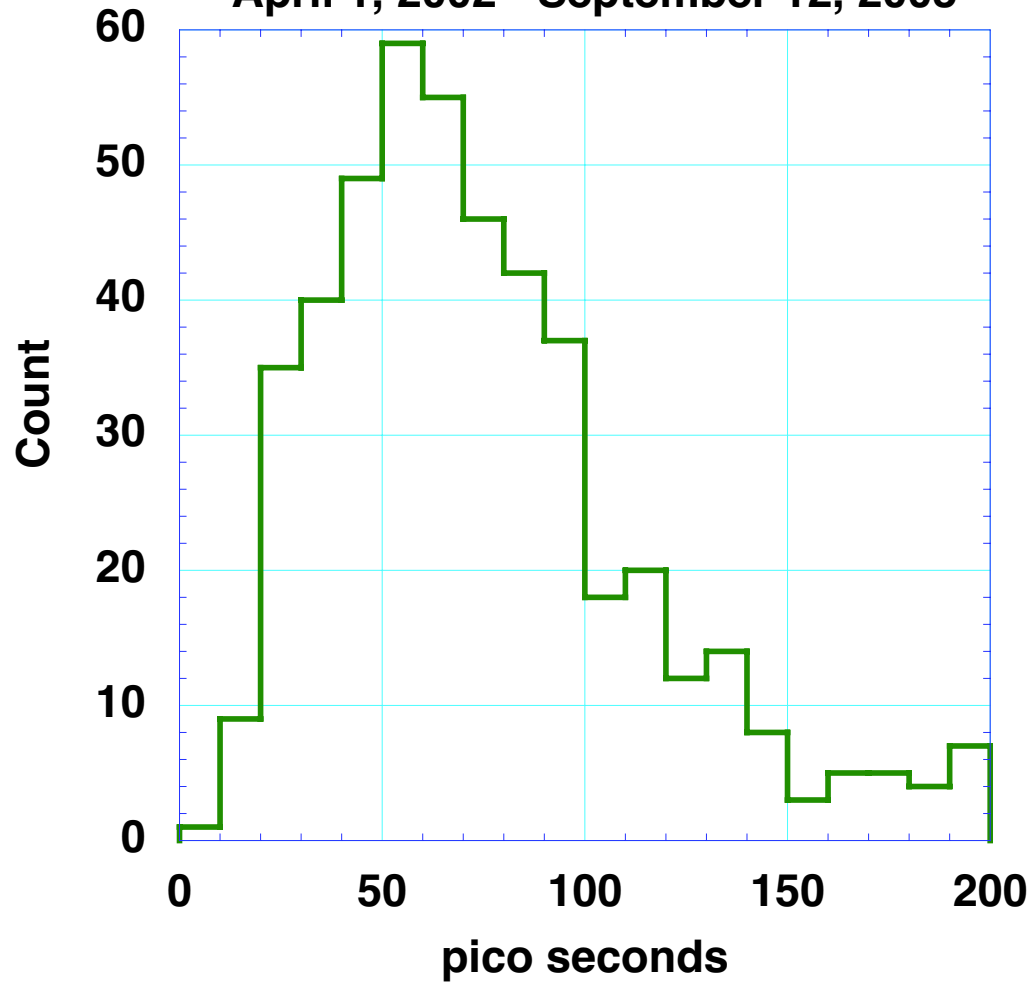

**Median: 68 ps =
2 cm
469 Days**

GPS Clock Solutions Detrended

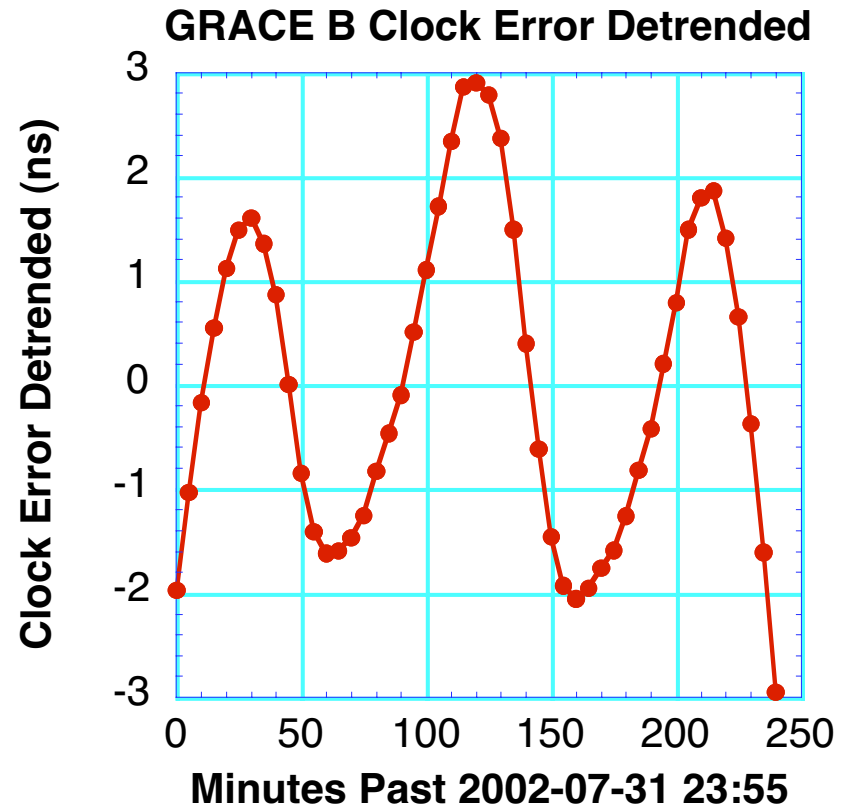
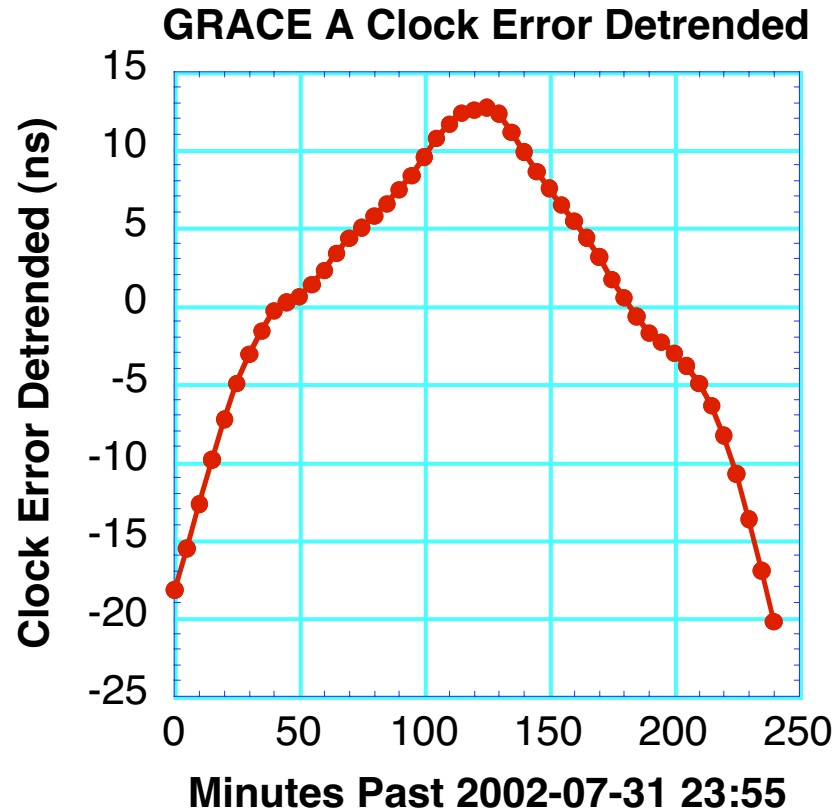

$$2*\sqrt{GM*a}e/c$$

KBR - GPS Relative Clock

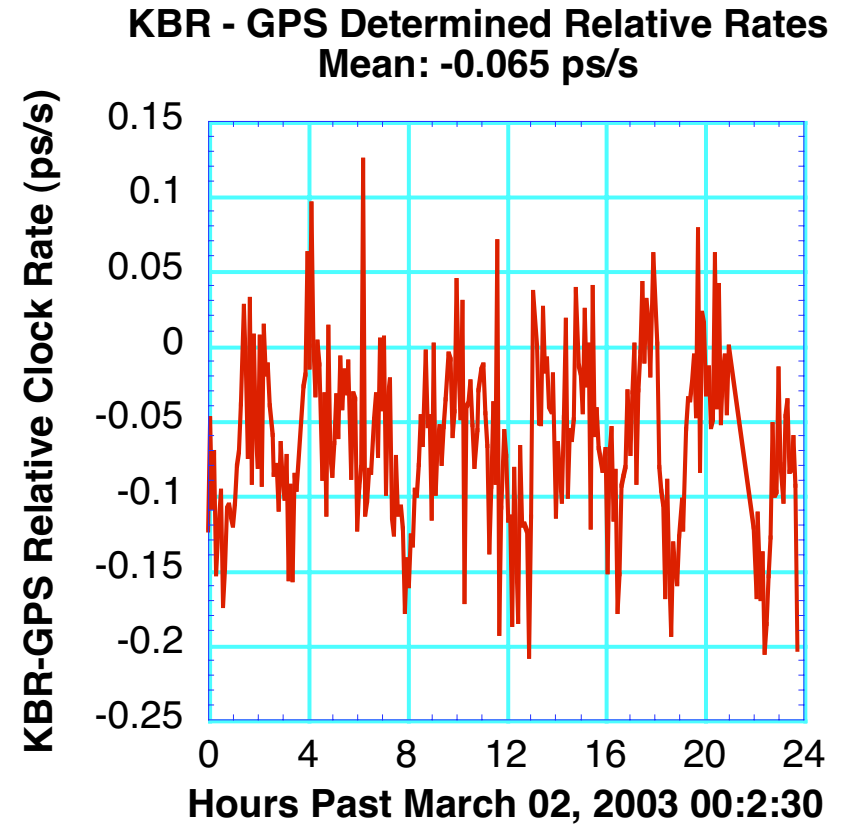
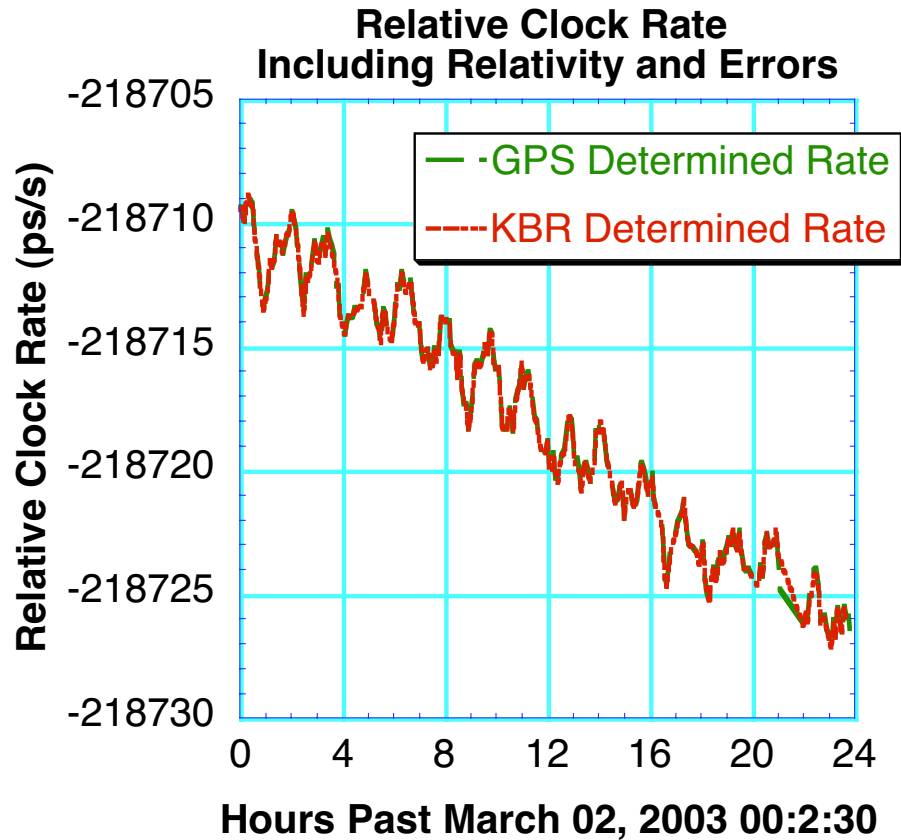

$$\frac{1.5\text{cm} \times 2\pi / 5400\text{s}}{c} \approx 0.06\text{ps/s}$$

Summary

- **GPS Relative Time Transfer for KBR Cal**
 - **68 ps**
 - **Periodic Errors**
- **New Method For Relative Clock Rate**
- **Relative Clock Rate, GPS/KBR Comparison**
 - **Unexplained Bias: 0.065 ps/s**
 - **Periodic Errors ~ 0.07 ps/s**
 - **Consistent With Expected GPS Errors**
- **Exceeding Requirements**

KBR Evaluation

- 10^{-4} cycles @ 1-Hz, single link
- $< 1 \mu\text{m/s}$ range-rate, 4 links 0.2 Hz

$(K - 0.75KA)_A - (K - 0.75KA)_B @ 10\text{Hz}$

Amplitude Spectrum 2003-01-02, 1-Hz RMS: 0.887

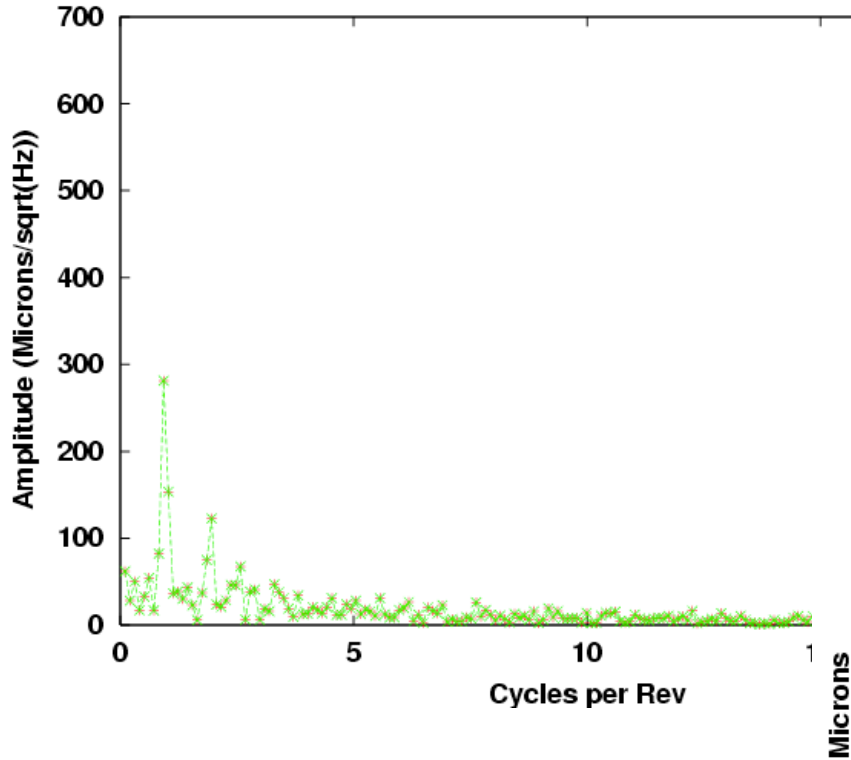

1-Hz RMS: 0.887 microns

Difference A,B K-.75Ka - Bias, 2003-01-02

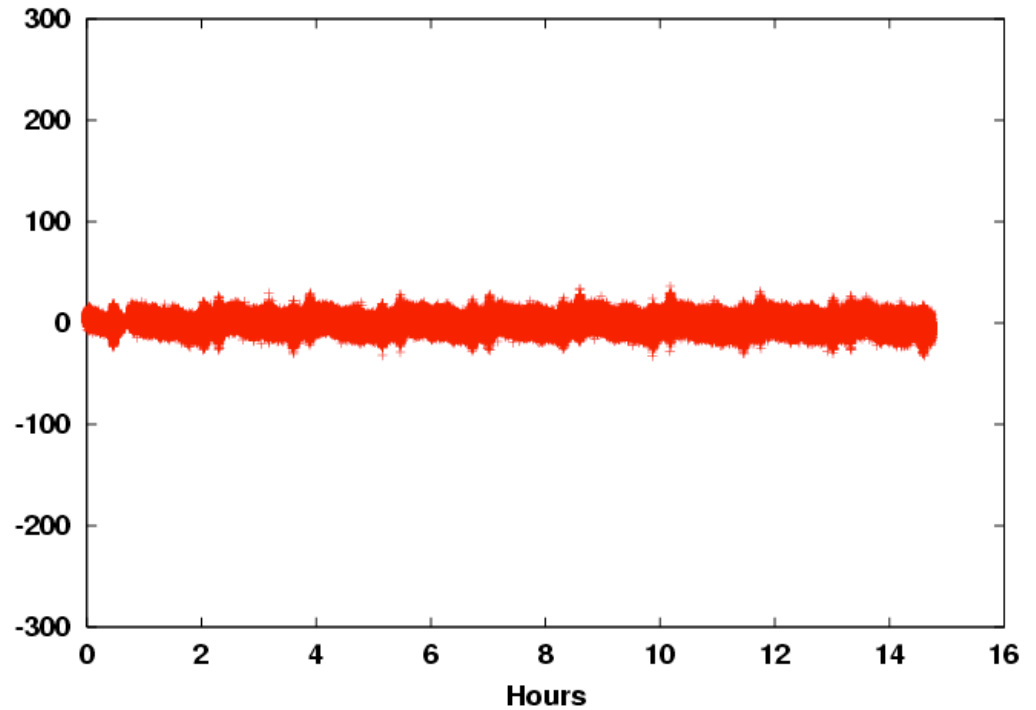

Sqrt(bandwidth) ~ 0.004 sqrt(Hz)

Histogram KBR Range-Rate Residuals, Gravity Fit

Residuals for November 2002 - RMS = 0.35 μ/s

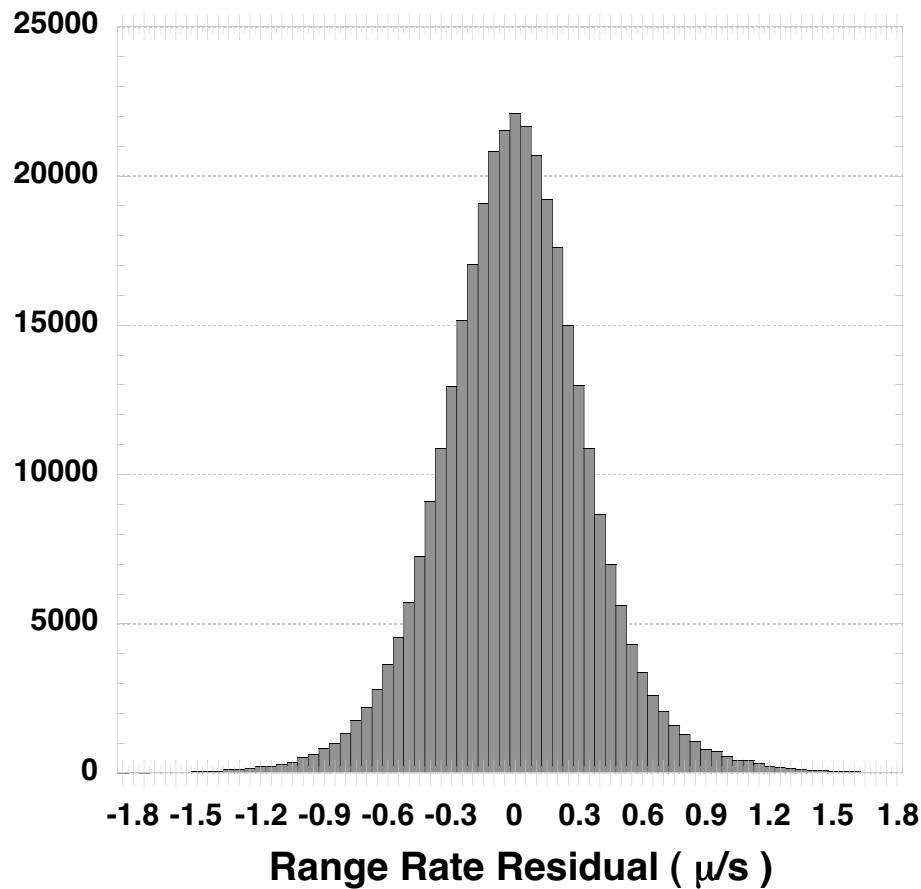

1-Hz, 0.2 Hz Star Camera

Residuals for April 2003 - RMS = 0.26 μ/s

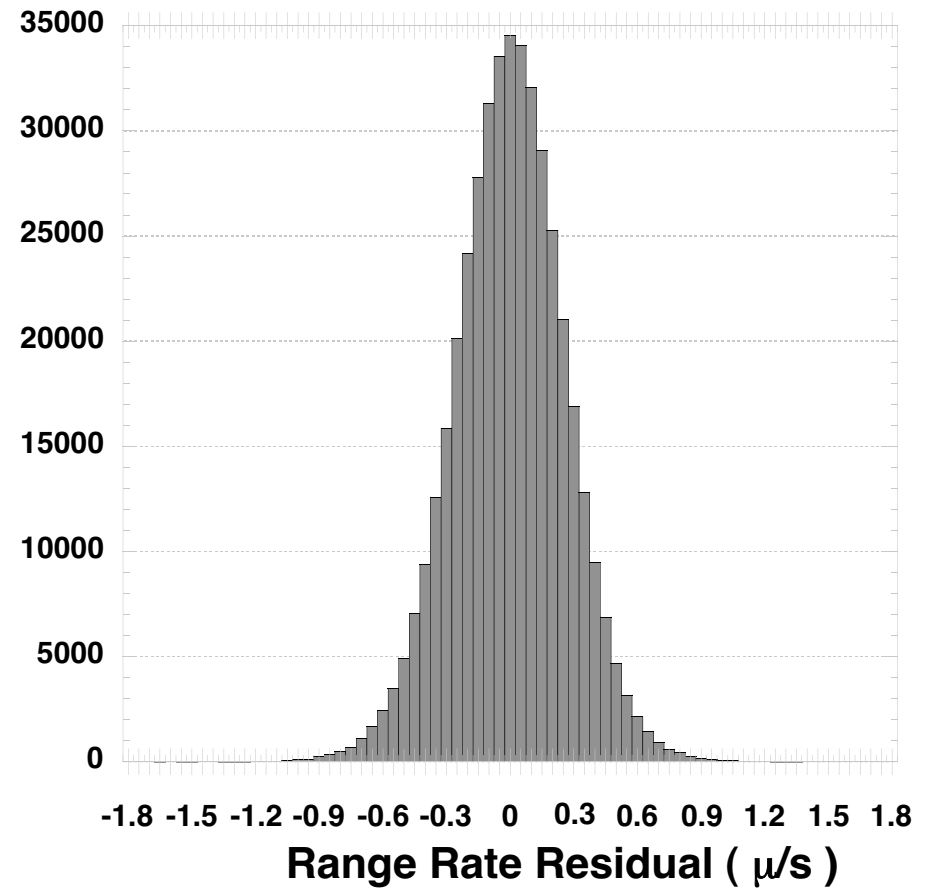

Dual 1-Hz Star Camera

Global High-Frequency KBR Validation

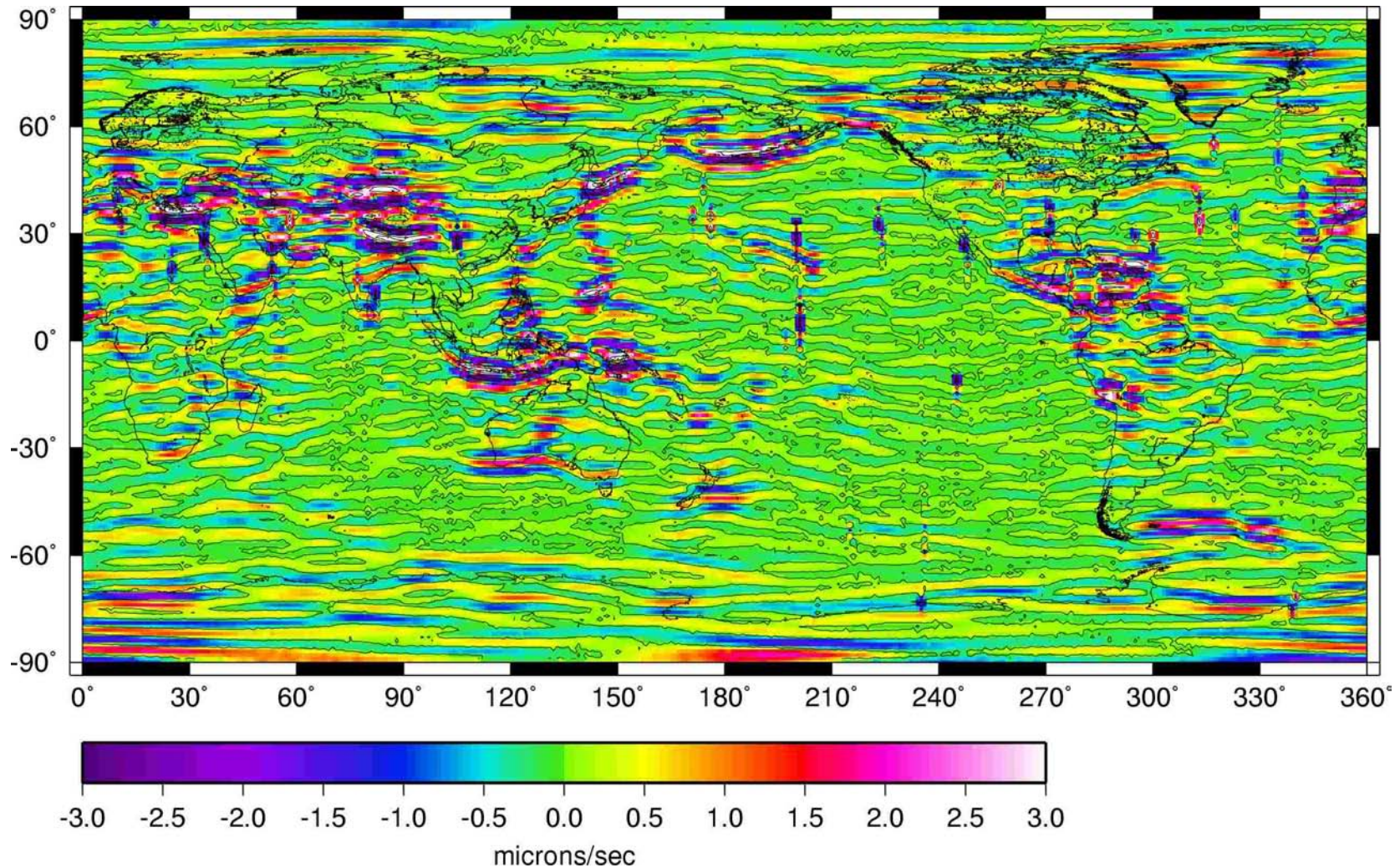

Himalaya - Detail

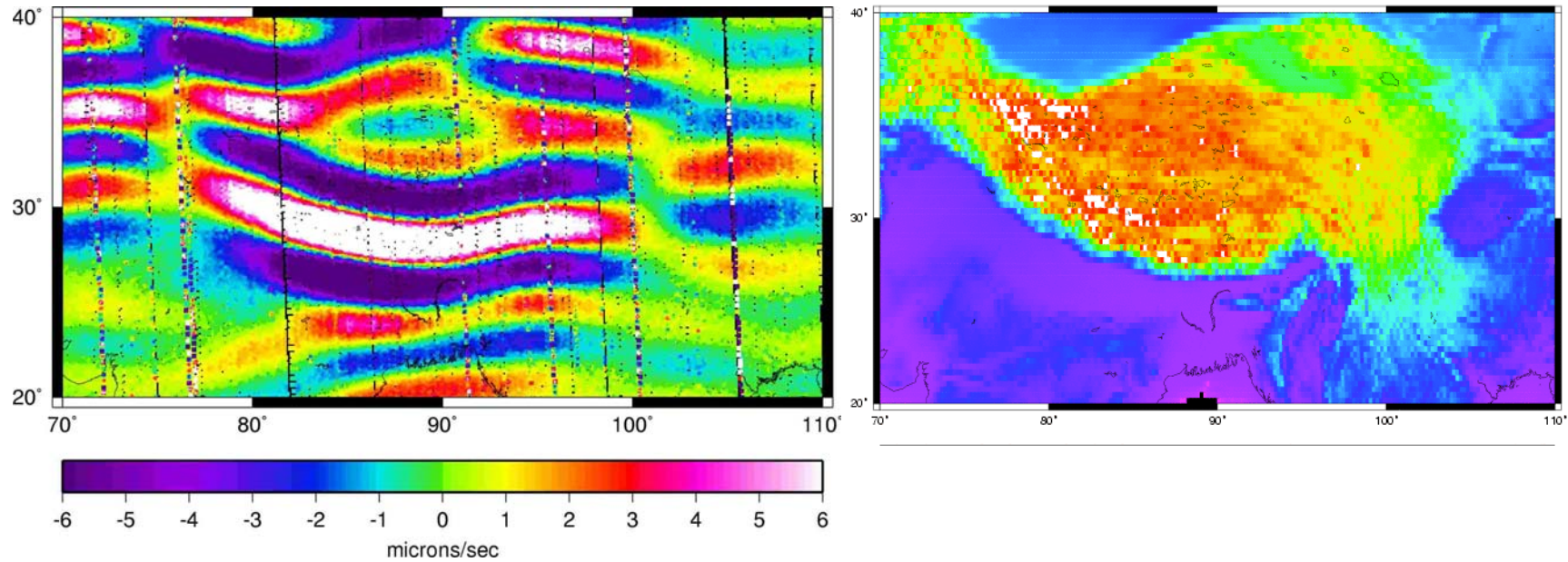

KBR range-rate residuals - correlations to topography

Star Camera Evaluation

Star Camera(SCA) Measurement

- 30 micro-radians = 0.002 deg (relative to Bore Sight)
- 240 micro-radians = 0.01 deg (roll around Bore Sight)
- **Accelerometer to inertial**
- **KBR Phase Center to CG**
- **On-Board Attitude Control**

Camera Differences: Roll, Pitch, Yaw Relative to SRF XYZ

Histogram of Grace-2 Roll/Pitch/Yaw inter-head difference
Variances (microrad): Roll 29, Pitch 194, Yaw 209

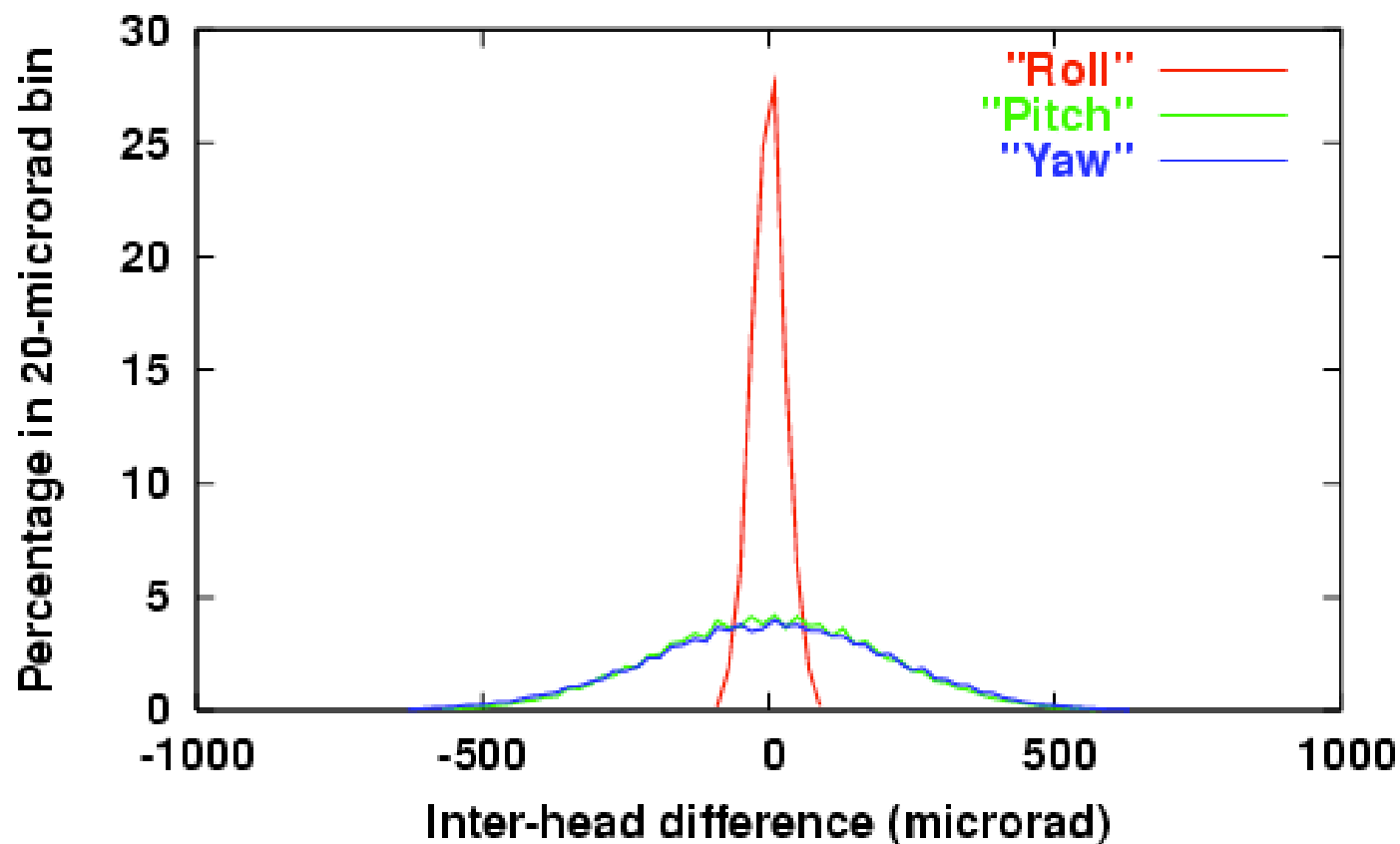

Roll/Pitch/Yaw Each Camera Head

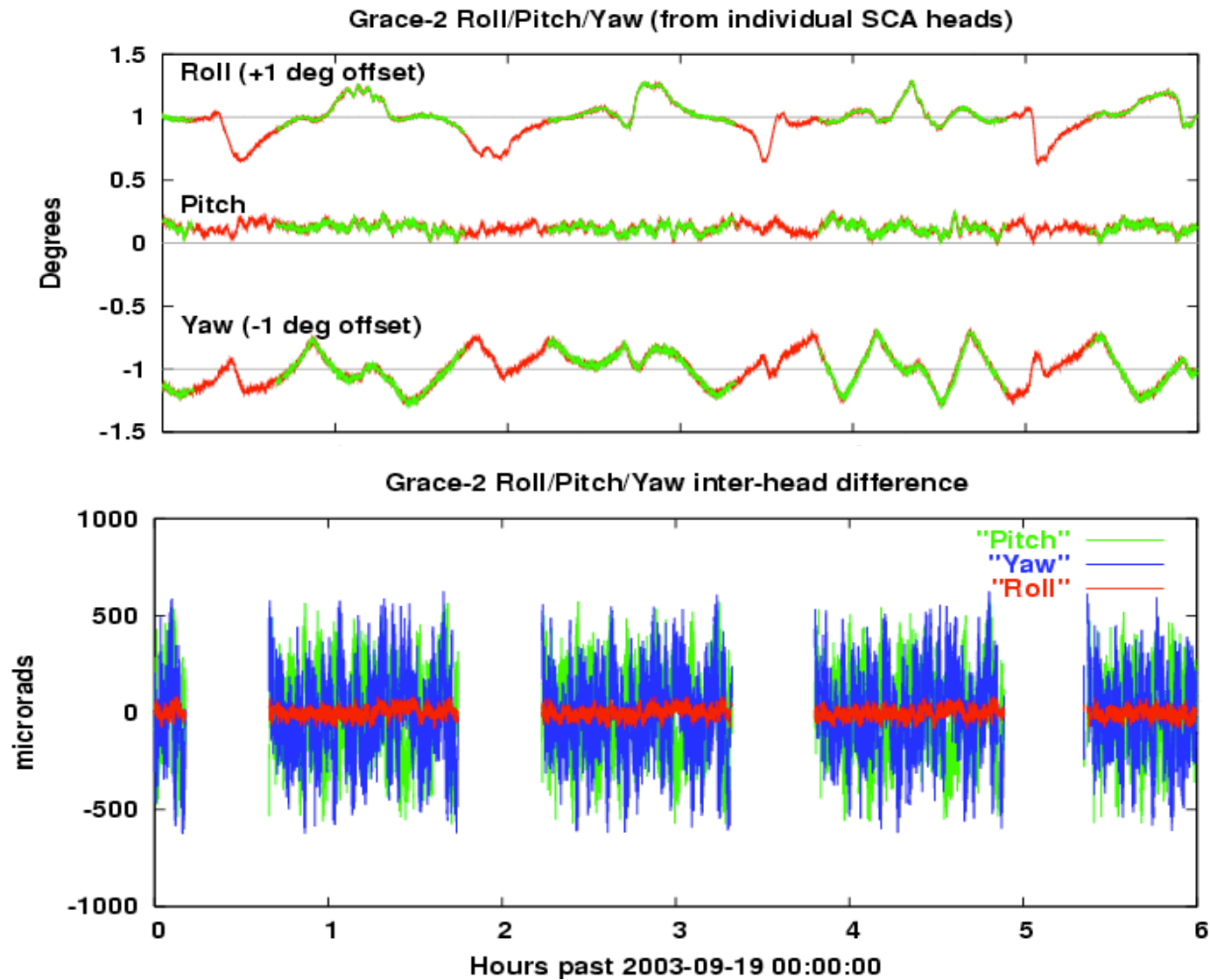

Bifurcation Example

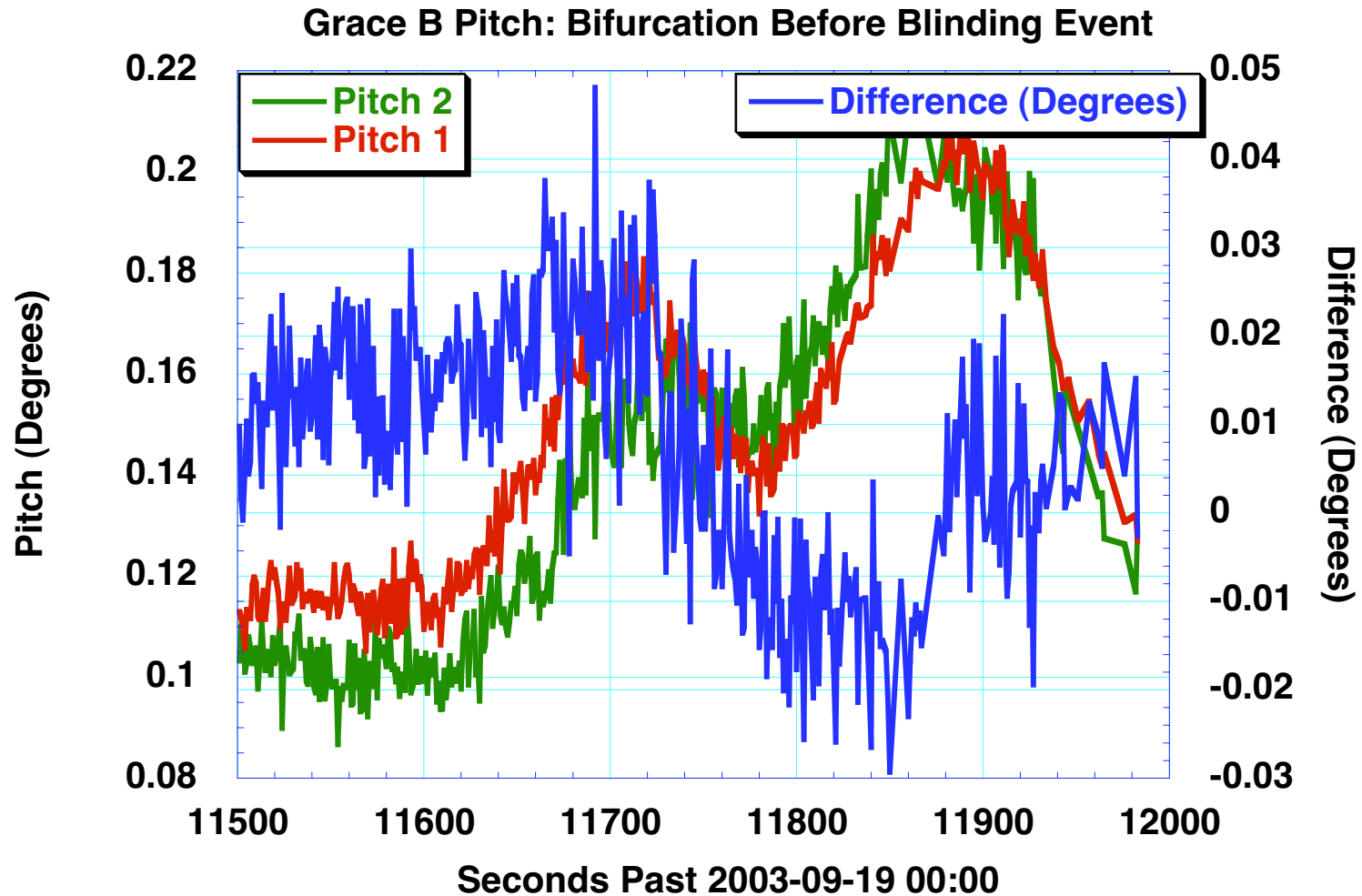

$1000 \text{ nm/s}^2 \times \sin(.02 \text{ deg}) \approx 0.4 \text{ nm/s}^2 \text{ radial}$

Integrating Angular Accelerations

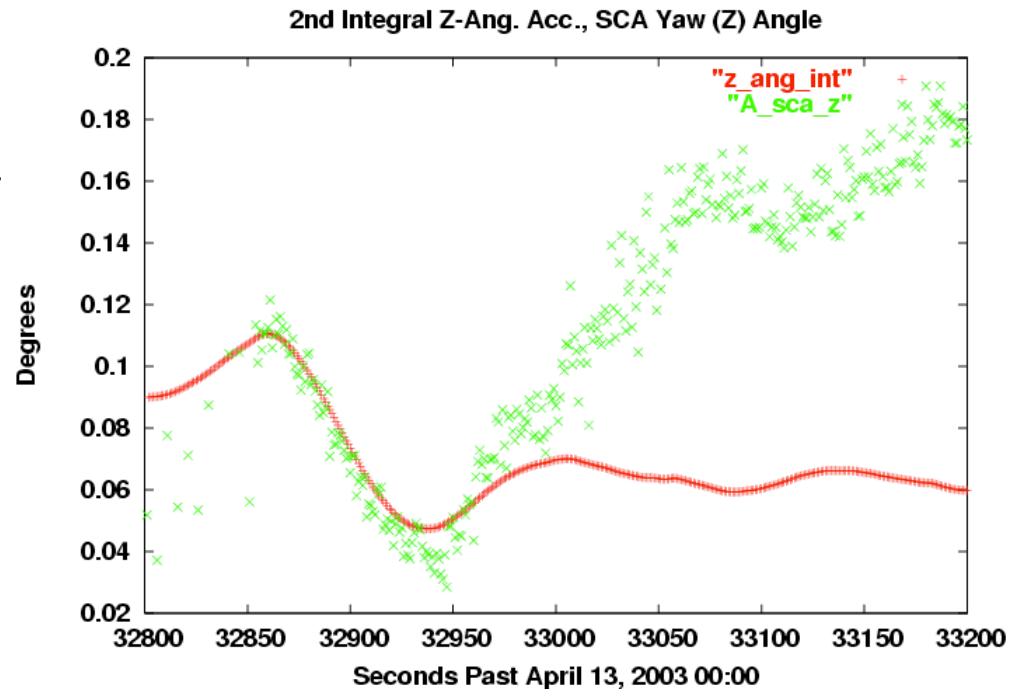
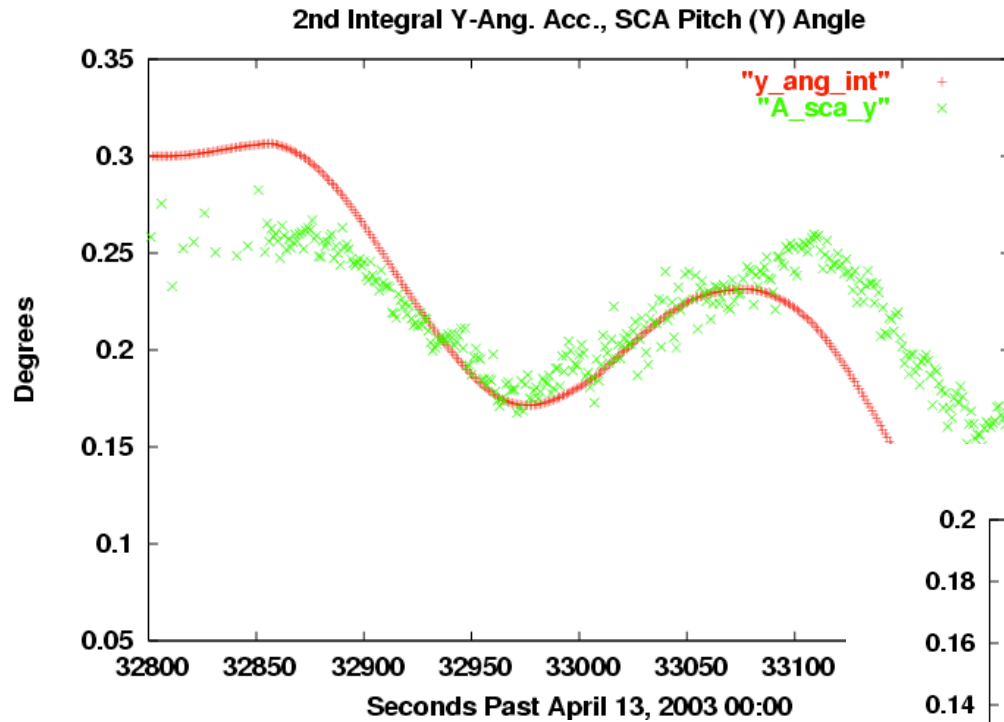

SuperSTAR Accelerometer

Srinivas Bettadpur

CSR-UT Austin

What the ACC Measures (& how well we can verify it)

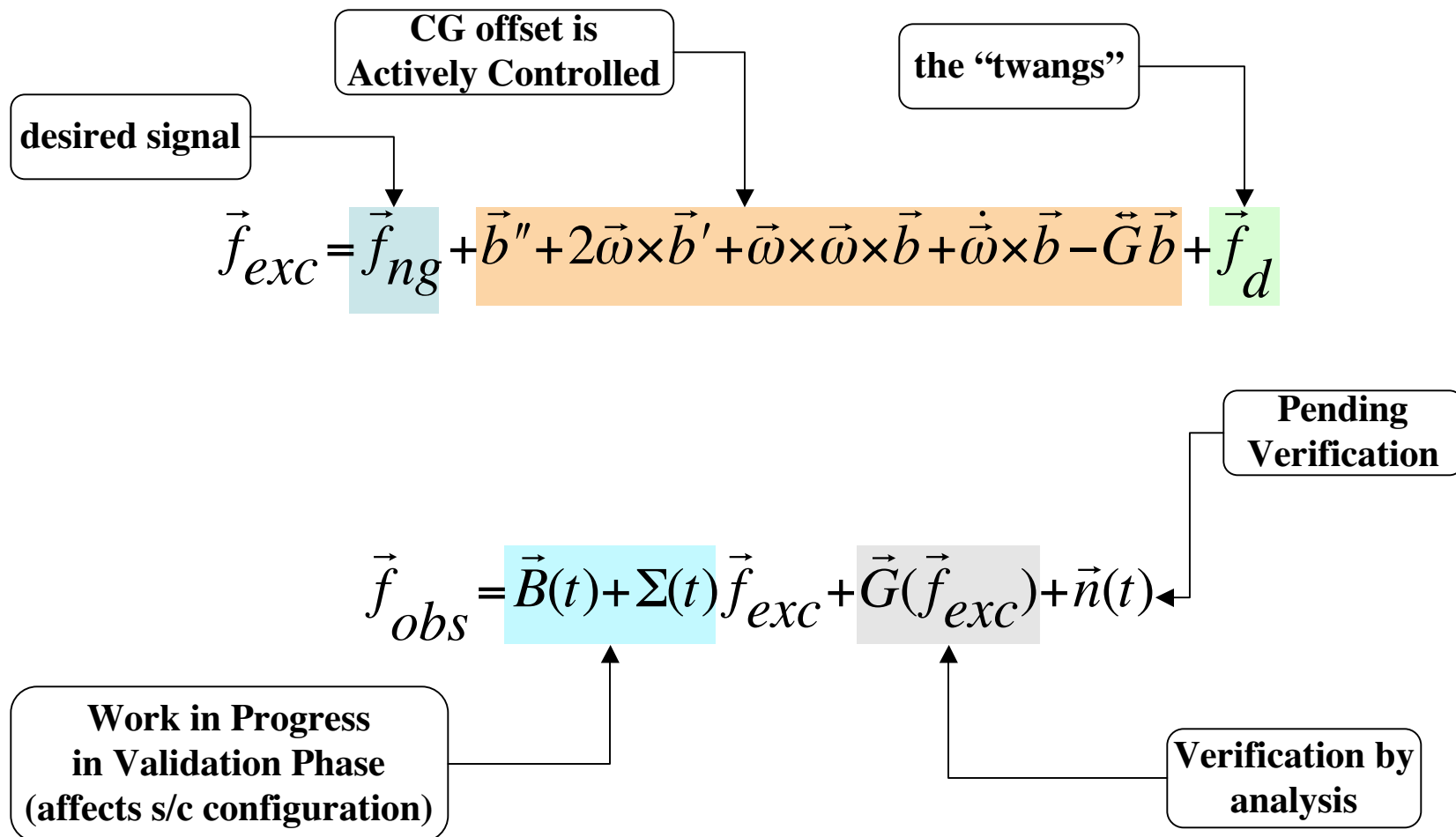

SuperSTAR Requirements

- Bandwidth: 50 μHz to 40 mHz (220 cpr)
 - Noise & stability requirements stated within this region
 - Measurement bandwidth is ≈ 3 Hz
- Instrument Dynamic Range
 - Normal Mode -- $\pm 50 \mu/\text{s}^2$ in y/z; $\pm 500 \mu/\text{s}^2$ in x
 - 24 bit analog-digital conversion (precision $\approx \text{xE-11}$)
- Stringent requirements on
 - Bias/Scale value & stability in thermal & magnetic environment
 - Instrument transfer function characteristics

Absolute Calibration Status

- Available Methods
 - Simultaneous Estimation with Gravity & Orbits
 - Comparison to models
- Status:
 - Scales known to $\approx 1\%$ (better along track ?)
 - Bias shows a long-term, linear trend
- Level-1B data users will be provided with best estimates of bias & scales
 - Data users may get best results by electing to make application specific estimates for these

The Twangs

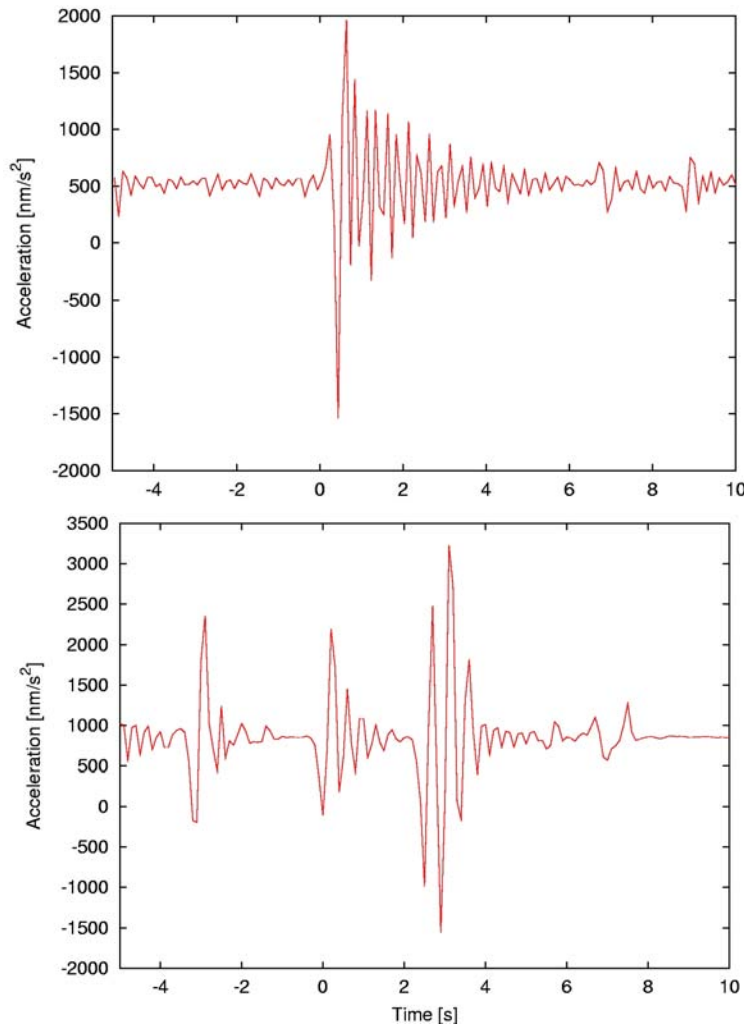

- Dominantly in the Radial (Y-acc) direction
- Signal is apparently unrelated to non-grav accelerations
 - hypothesized to be from nadir-side Teflon radiator
 - Has a seasonally changing, geographically correlated distribution
- Area under the curve is near zero
 - verified to $\approx 3\text{-}8$ nano-m/s² acceleration equivalent

Twang Residual Acceleration

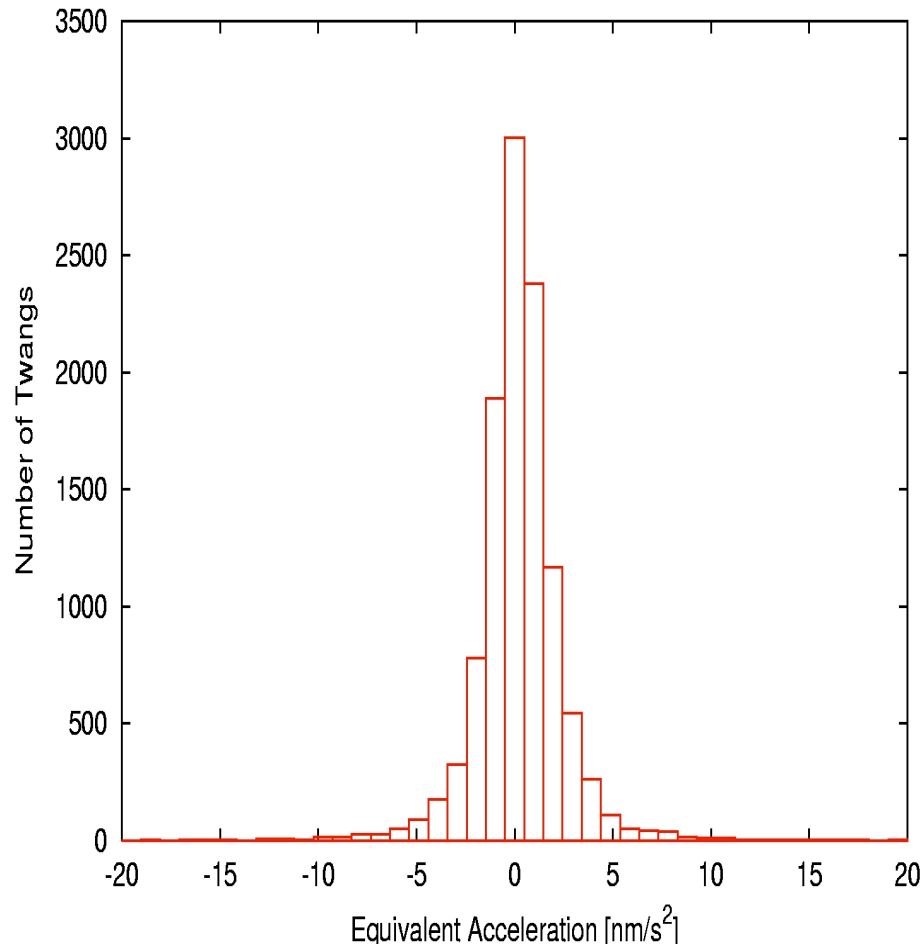

- 87 % of examined twangs have residual acceleration equivalent less than 3 nm/s²
 - 99.9 % < 8 nm/s²
- The Level-1 data filter is area preserving
 - resulting ACC1B product should be immune to twangs at this level

Relative Calibration using Dual ACC Data

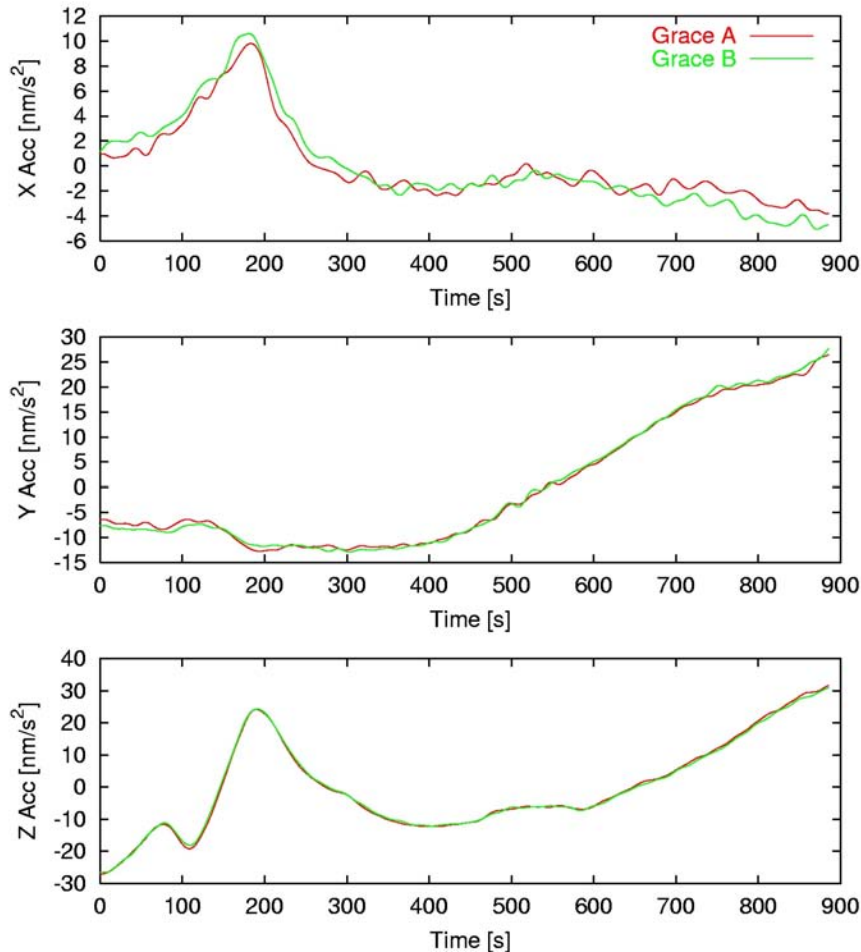

- The data are aligned by position in Earth-fixed frame
- Aligned data can be used for relative bias & scale calibration
 - Residual relative to calibration is an upper bound on noise

Relative Calibration Residuals

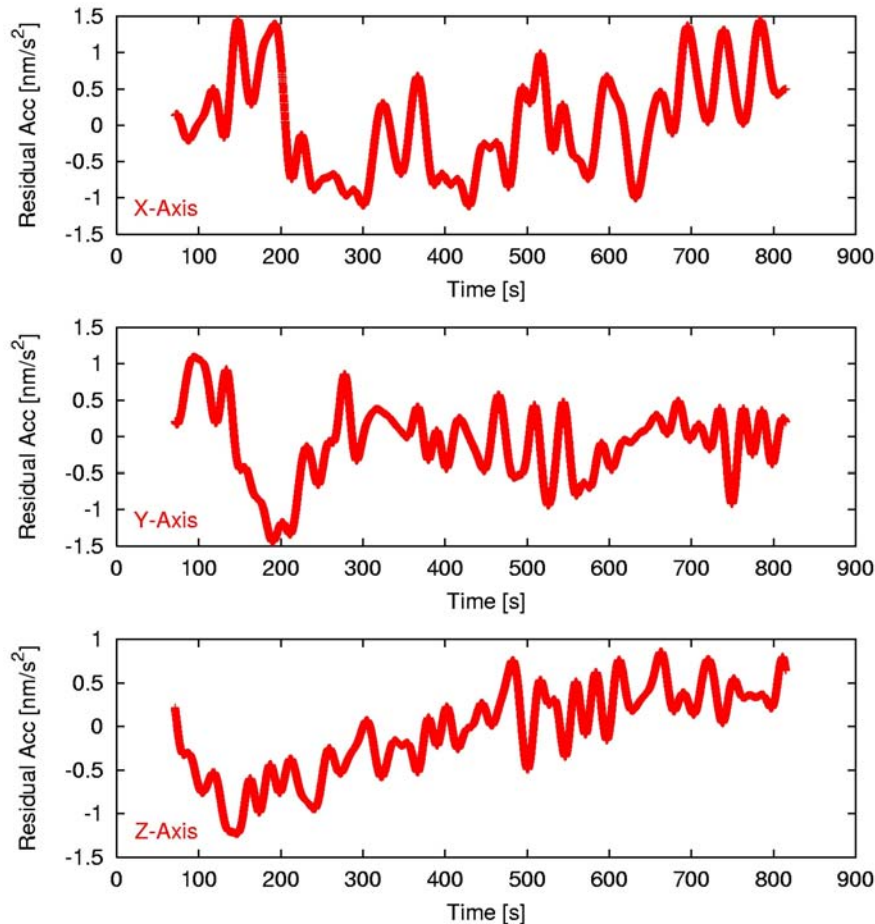

- Relative calibration residuals depend on
 - ACC measurement errors
 - measurement noise
 - thermal variations
 - Residual variability of attitude & density
 - Differences from flying forwards & backwards
- Upper Bound Error RMS in 1 to 35 mHz bandwidth
 - X (cross-track) = 0.44 nm/s^2
 - Y (radial) = 0.50 nm/s^2
 - Z (along-track) = 0.40 nm/s^2

Overall Assessment

- Error analysis is in progress
 - Long term (> 1 day) mitigated by parametrization
 - Mid term (1 day to 1 rev): not yet fully characterized
 - Temperature dependent calibration is pending
 - Short term (1 mHz to 35 mHz)
 - have an upper bound of approximately 0.5 nm/s^2 RMS (including noise & variability between satellites)
- With non-gravitational force variability near 300-500 nm/s^2 , we are exploiting the data (in a geodetic sense) to a “few” ($\approx 1-10$) nm/s^2 , depending on the frequency & the axis.

GRACE in-flight Calibrations

Larry Romans & Furun Wang

**Willy Bertiger, Srinivas Bettadpur,
Gerhard Kruizinga, Sien Wu**

Overview

- **Introduction**
 - **Center of Mass Calibration**
 - **KBR boresight Calibration**
- **In-flight experiments & trims**
 - **Center of Mass Calibration**
 - **KBR boresight Calibration**
 - **SCA-ACC alignment**

GRACE Science Instrumentation

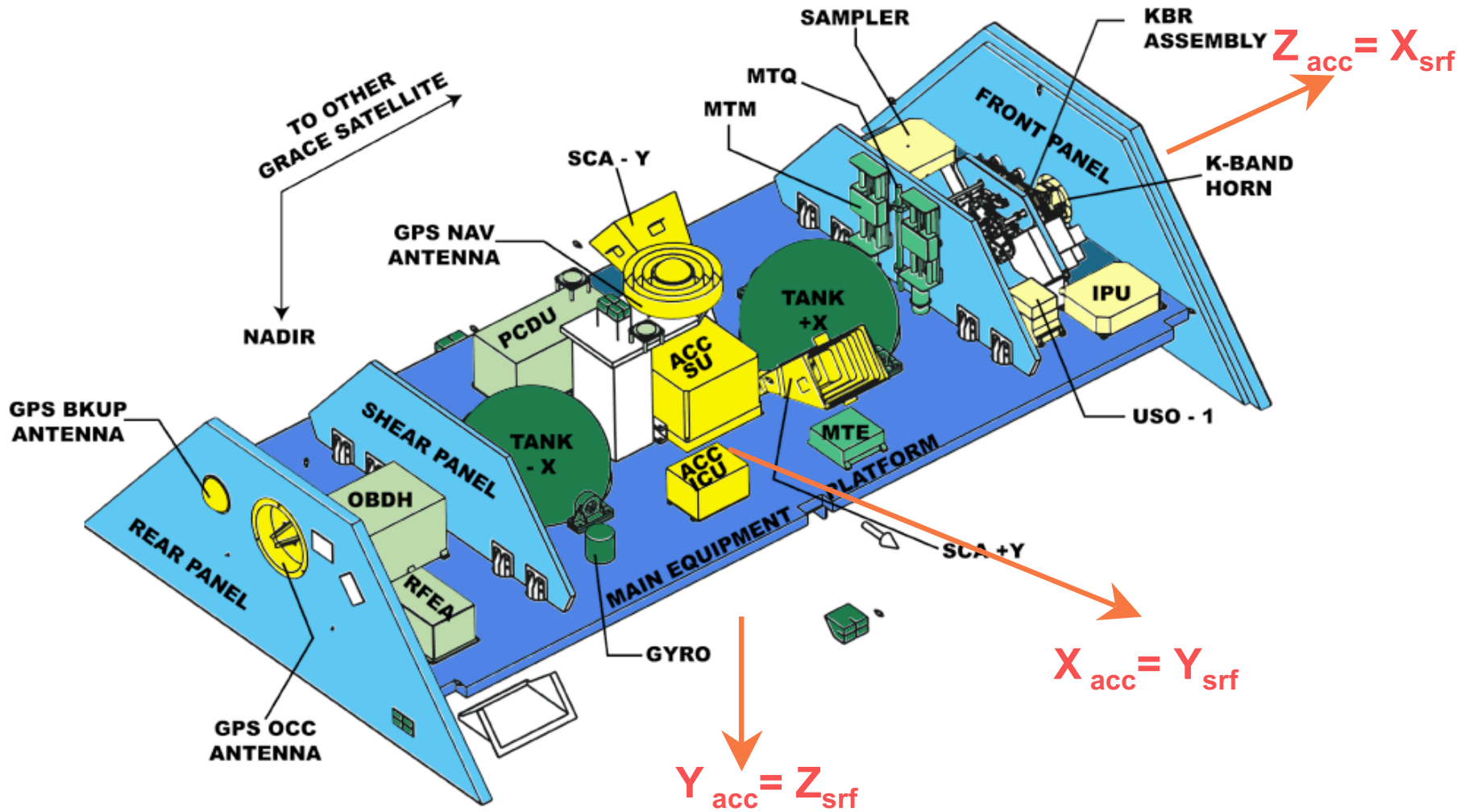

Center of Mass Calibration

- **Objective:**
 - **Make the satellite CG coincident with the center of the ACC proof-mass**
 - **Measure offset with calibration maneuver**
 - **Trim offset with Mass-Trim-Electronics**
- **Calibration Maneuver profile:**
 - **Oscillate the spacecraft - along three independent axes - at a given frequency and look for a CG offset induced linear ACC response at the given frequency.**
 - **Use the observed response in linear accelerations to determine the CG offset**

Center of Mass Calibration maneuver

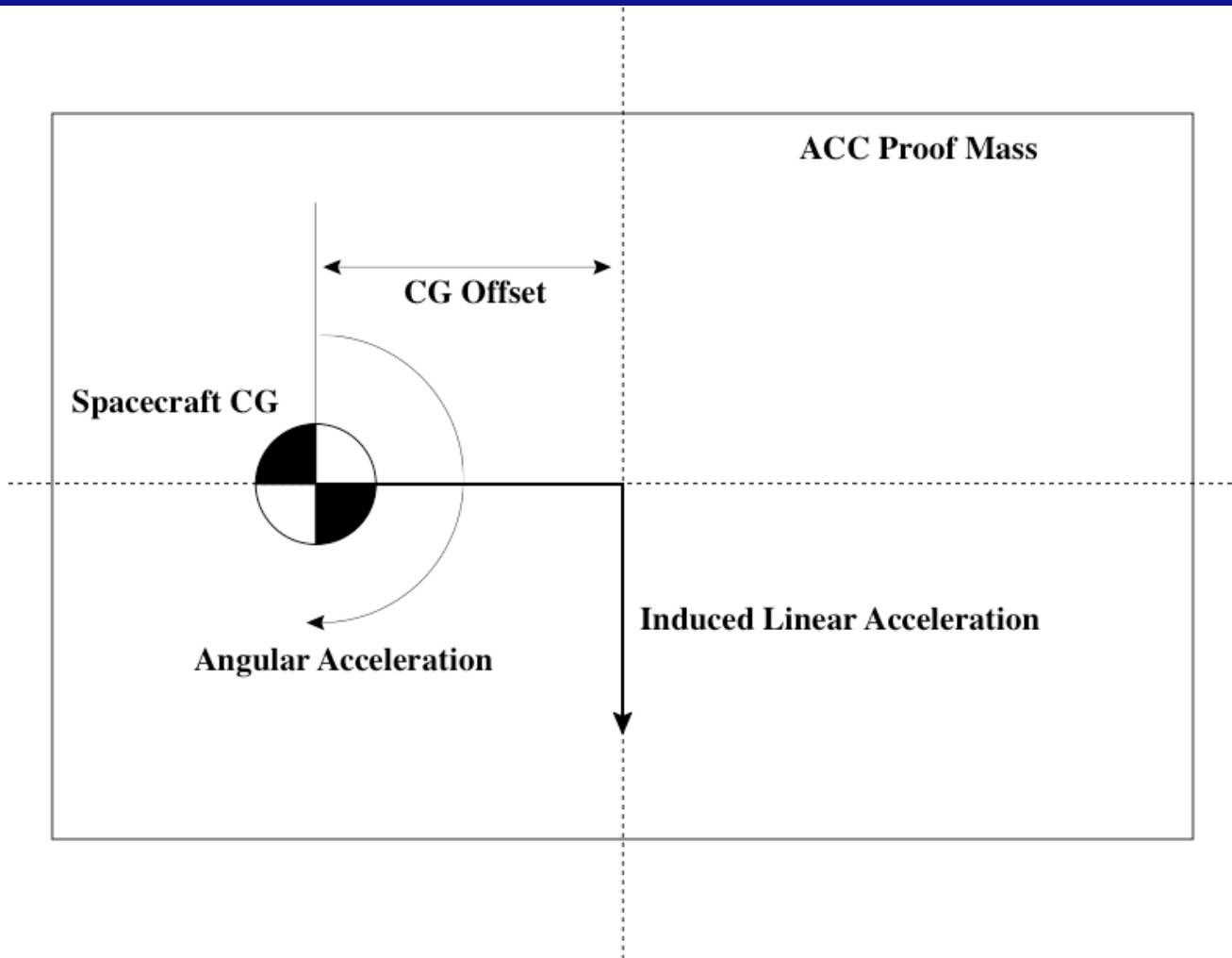

Center of Mass Results from CMCAL for GRACE-1

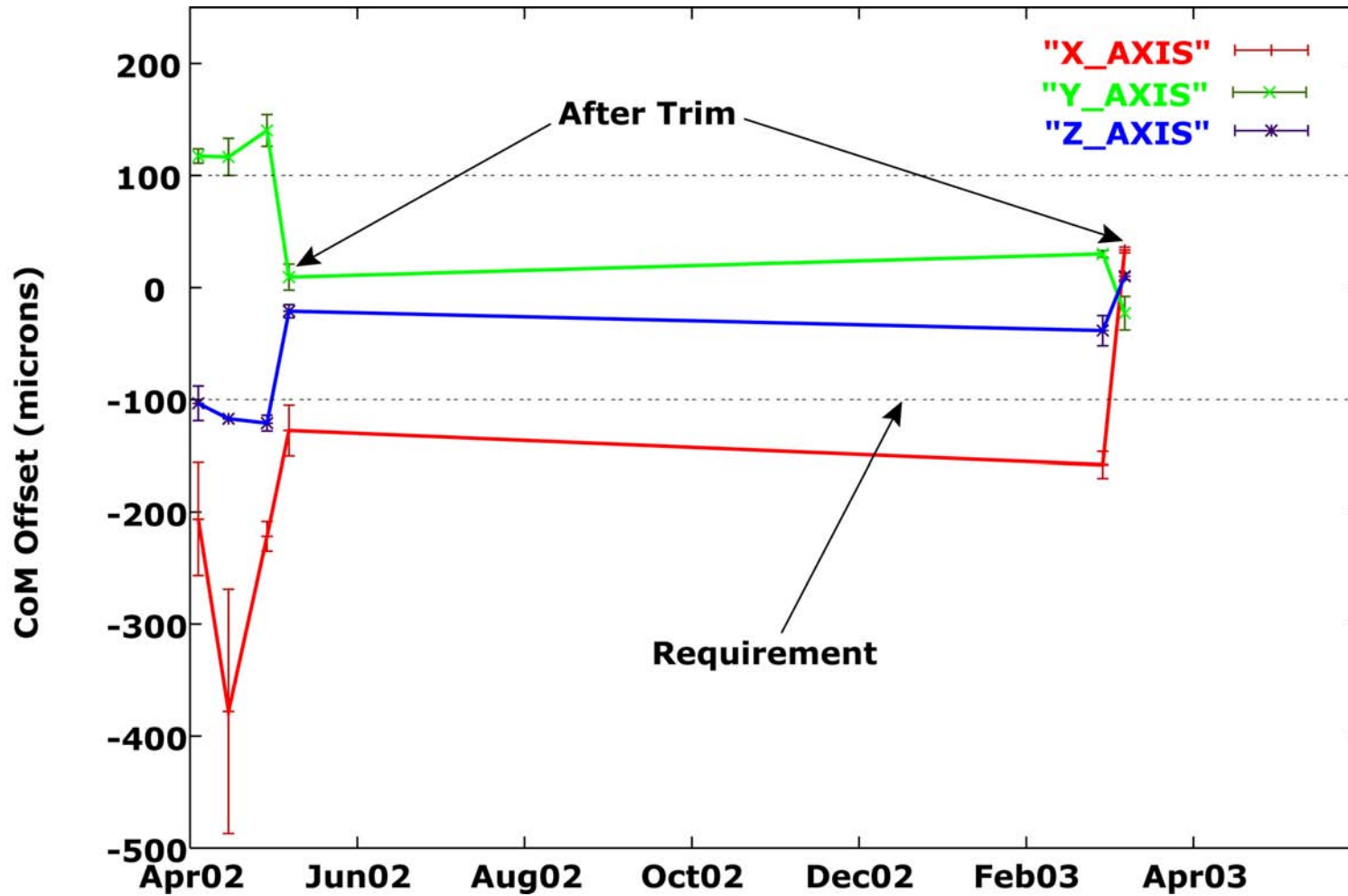

Center of Mass Results from CMCAL for GRACE-2

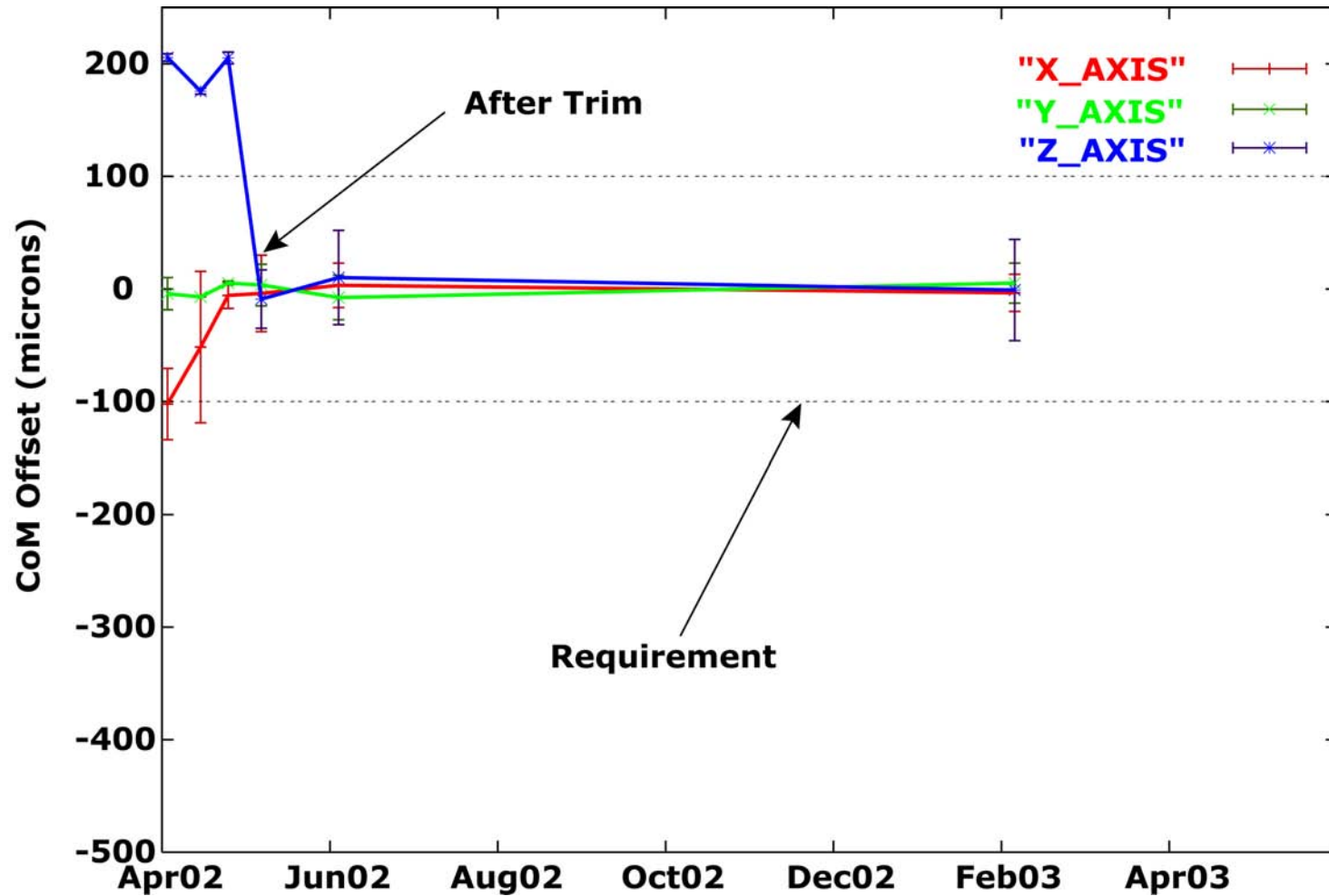

X-axis Center of Mass Variation for GRACE-1

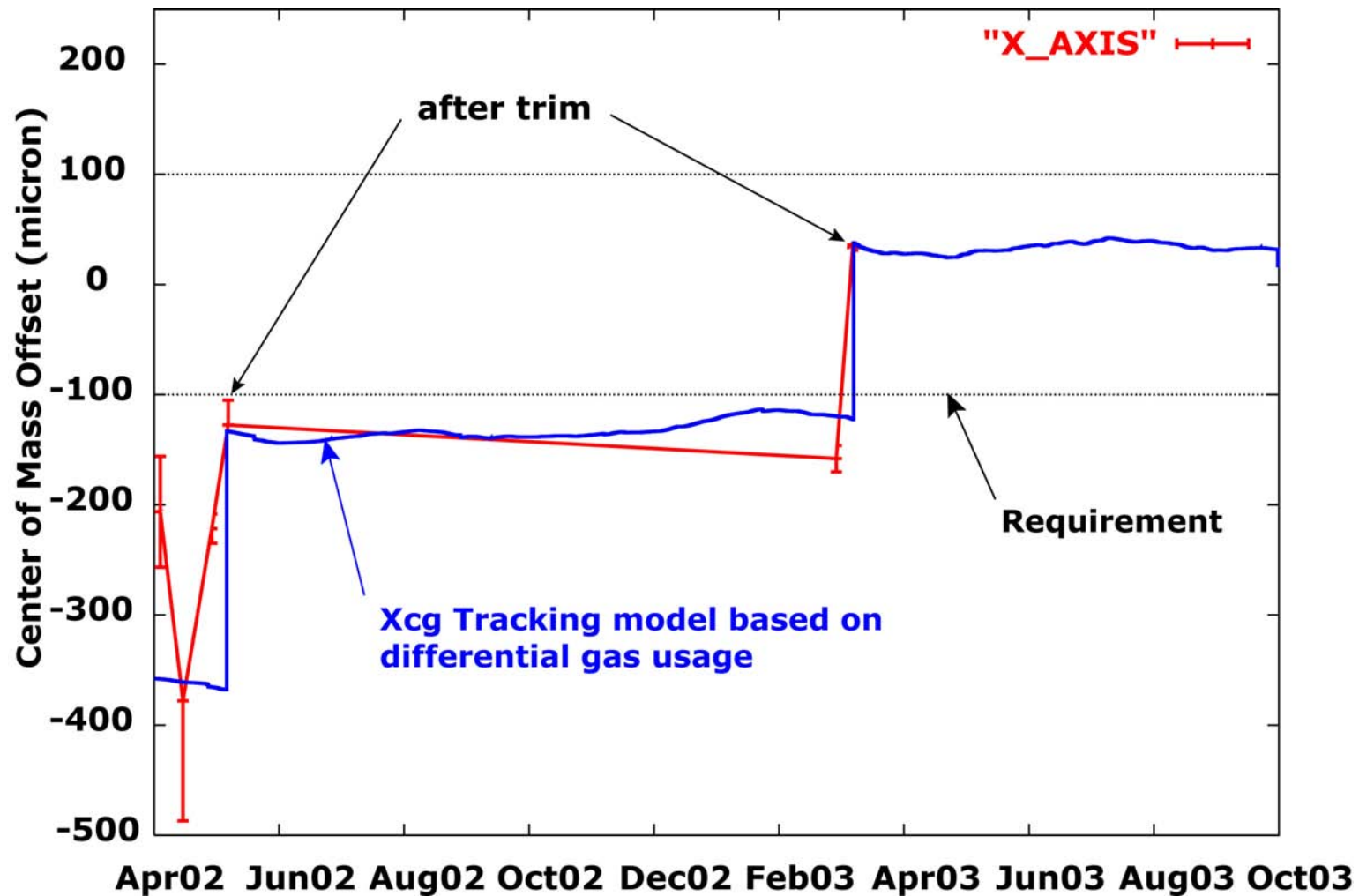

X-axis Center of Mass Variation for GRACE-2

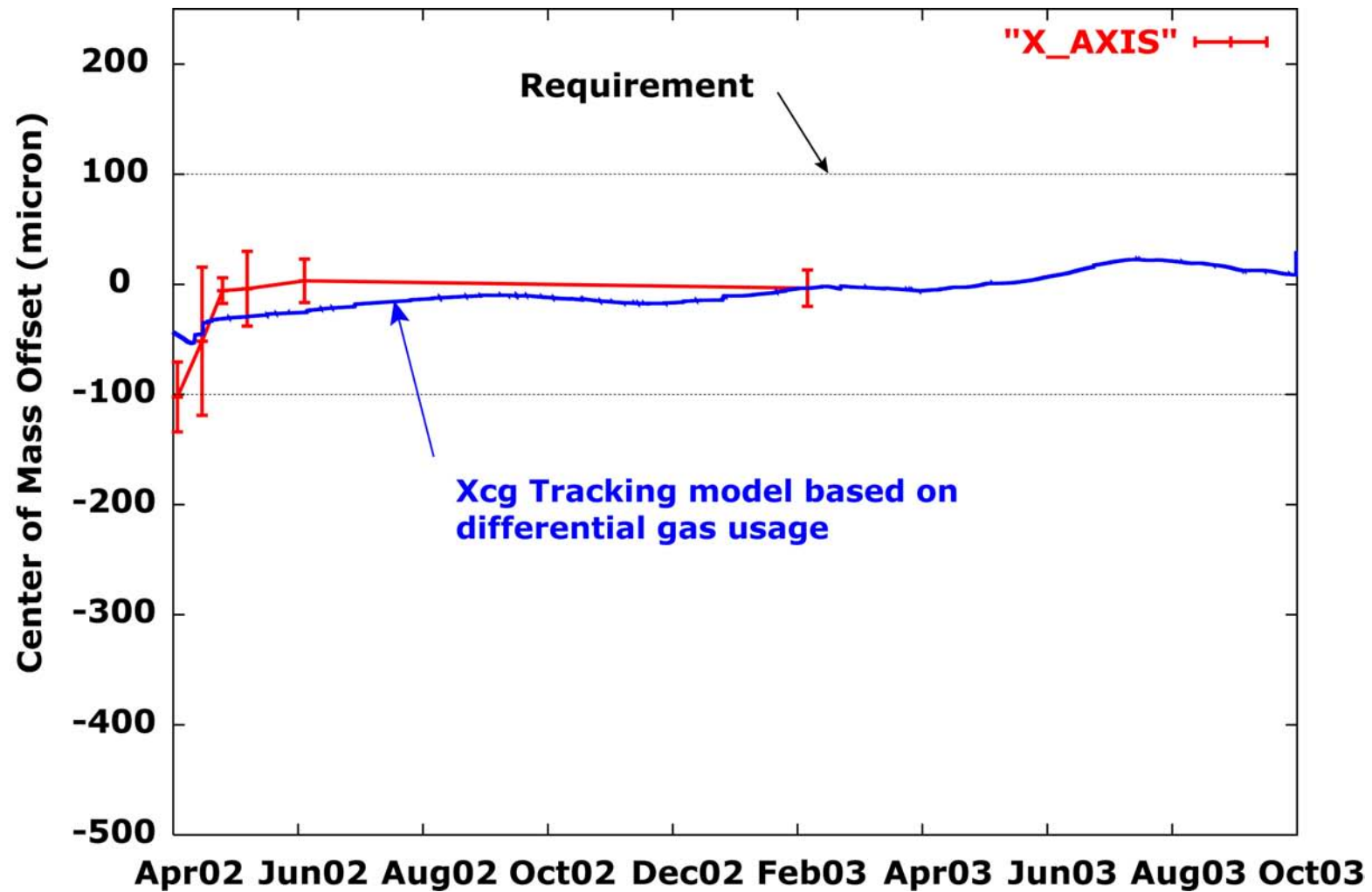

KBR boresight calibration

- **Objective:**
 - **Measure the KBR boresight alignment wrt Star Cameras**
 - **Measure the alignment of the ACC wrt Star Cameras**
- **Maneuver profile:**
 - **Oscillate the spacecraft at a given frequency and use induced range changes to determine KBR boresight pointing in SCA Frame**
 - **Use SCA and ACC angular accelerations to determine their relative alignment**

KBR bore sight calibration maneuver

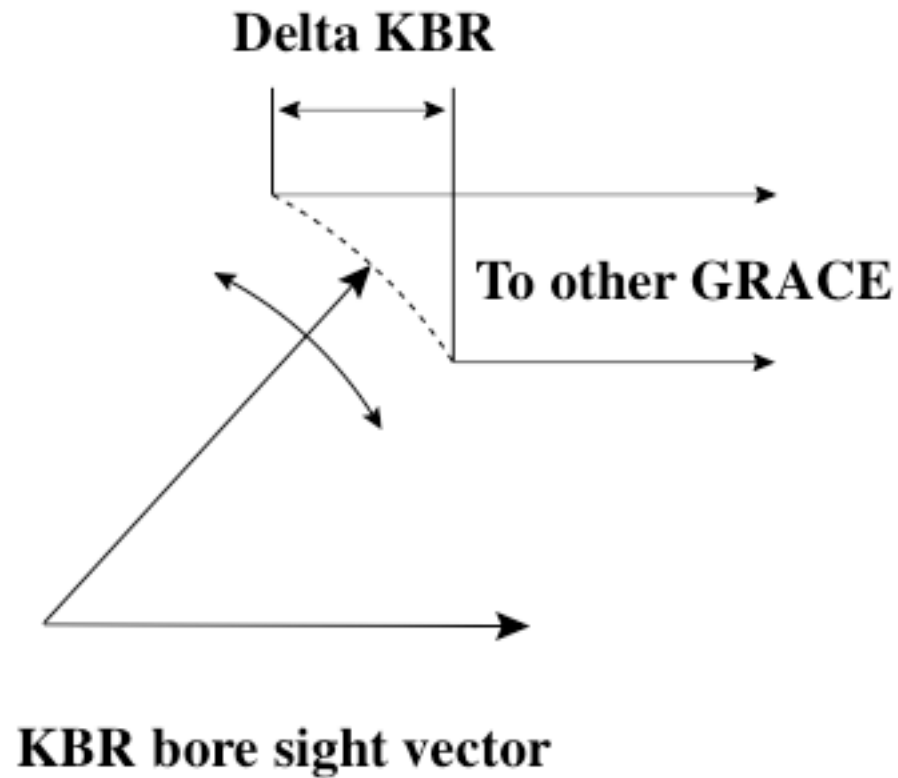

SCA-ACC Alignment for GRACE-1 & 2

- **SCA-ACC alignment ($\approx 0.03^\circ$ accuracy)**
- **GRACE-1 (wrt idealized RA , Dec and Twist in deg)**
 - **SCA1 (RA = 0.183, Dec = -0.851, Twist = -0.140)**
 - **SCA2 (RA = 0.521, Dec = 0.111, Twist = -0.430)**
- **GRACE-2 (wrt idealized RA, Dec and Twist in deg)**
 - **SCA1 (RA = -0.590, Dec = -0.328, Twist = -0.197)**
 - **SCA2 (RA = -1.490, Dec = -0.455, Twist = 1.082)**

KBR Bore-sight Alignment for GRACE-1 & 2

accuracy $\approx 0.02^\circ$

GRACE-1

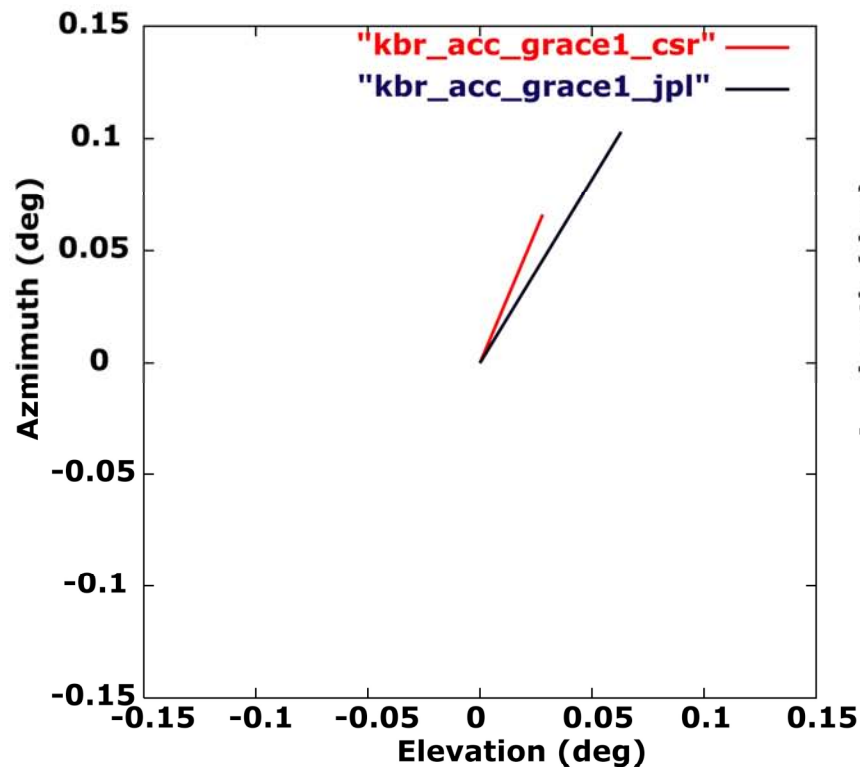

GRACE-2

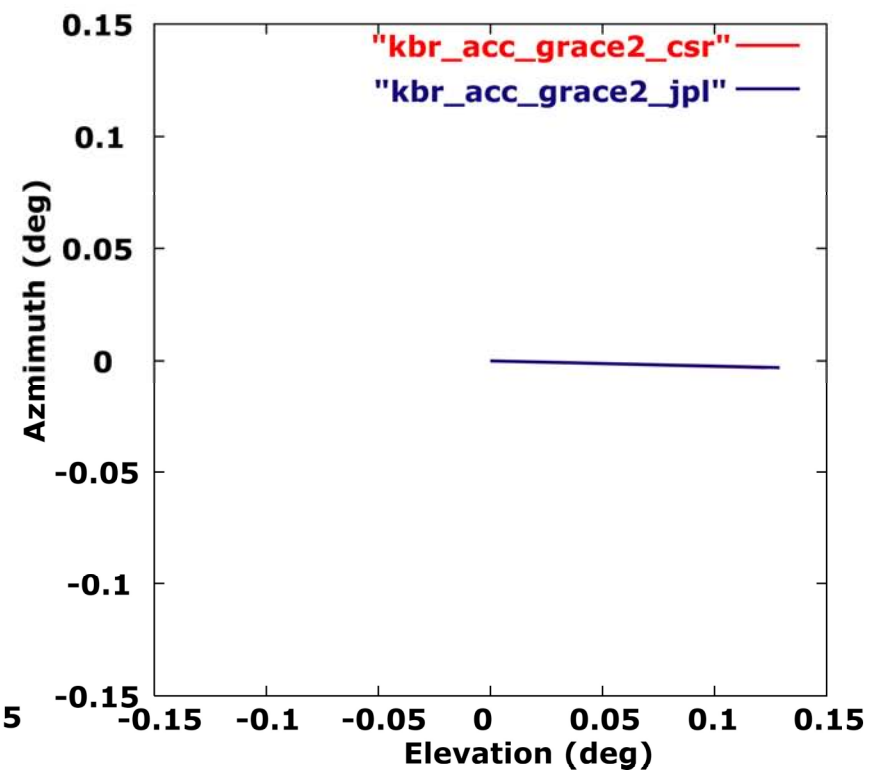

Summary

- **Good agreement between alignment & calibration results between JPL and CSR**
- **CM Offset is within requirements**
 - **CM Variability is being tracked by the SDS**
- **Calibration maneuvers will be repeated as needed**
- **Level-1B data uses best estimates of these alignments**
 - **The alignments are provided to the user**

SCA-ACC Alignment (in SRF) for GRACE-1 & 2

Preliminary SCA bore-sight locations in ACC frame

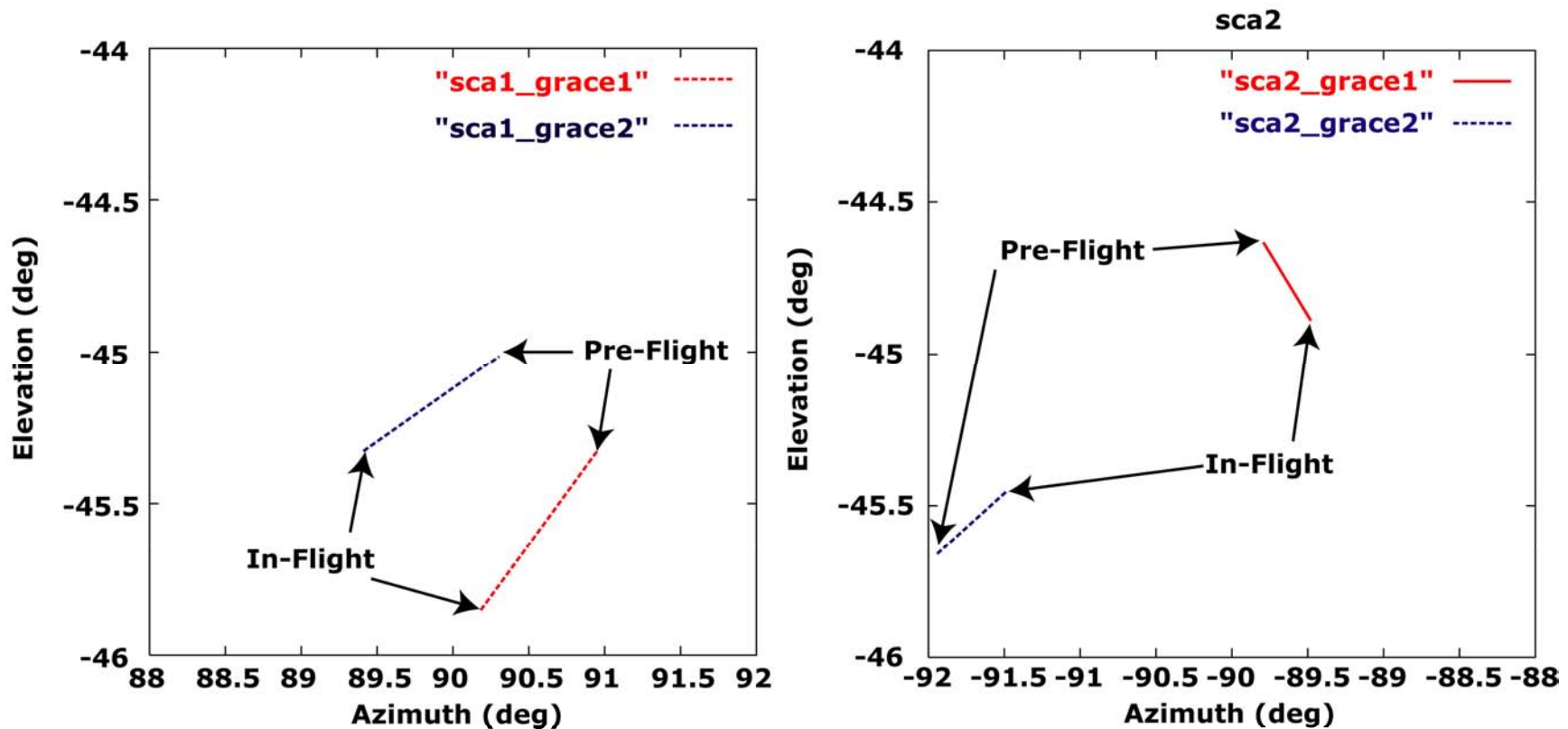

Additional Resources for Users

or -- would you like fries with that !?!

User Resources

- Documents
 - Both PO.DAAC & ISDC distribute e-docs
- Web Pages
 - Displaying evolving trends in the flight system
- Sequence-Of-Events (SOE) Files
 - Plain text files with listing of main events
- Email help

Product Specification Document

- Mnemonics & description of all products
- Satellite Macro Model
 - Dimensions & Surface properties
- Ancillary Information
 - Also contains a brief description of telemetry data contents in an Appendix
 - Coordinate & Time system definitions
 - Actual values (or “realizations”) are contained within science data products

Level-1 & Level-2 Data User Handbooks

- Description of the data products
- Data usage guidelines
- Data formats
 - Level-2 formats are in separate document

Level-2 Algorithms Document

- Detailed description of:
 - Mathematical Models & Parameters
 - Processing Standards
 - Parametrizations

GRACE Project Ops Pages

- Orbit Evolution
 - Orbit geometry
 - Long-term & short-term evolution of the orbit
 - Special events
- Data processing
 - Data processing task monitor
 - Data quality status, trends & history
 - CG Offset tracking, etc
- Password controlled access to be enabled ca. Spring 2004

GRACE Science Team Meeting

GRACE Gravity Field Performance and Error Assessment

Level-2 Processing Team

October 8-10, 2003



GRACE GRAVITY MODEL 01

- 111 days of GRACE data (Apr-Nov, 2002)
 - KBR range-rate and GPS phase data
 - Attitude from star camera
 - Non-gravitational accelerations from SuperStar accelerometer
- Estimated parameters
 - Initial conditions for daily arcs
 - Accelerometer biases (daily) and scale factors (global)
 - KBR biases, GPS ambiguities and zenith delays
- Estimate 120x120 using only data from GRACE (GGM01S)
 - No 'Kaula' constraint, no other satellite information, no surface gravity information and no other *a priori* conditioning
 - GGM01C combines GGM01S with surface gravity and mean sea surface information from TEG4 (to 200x200)
- **More recent monthly solutions based on current data release (Version 0)**

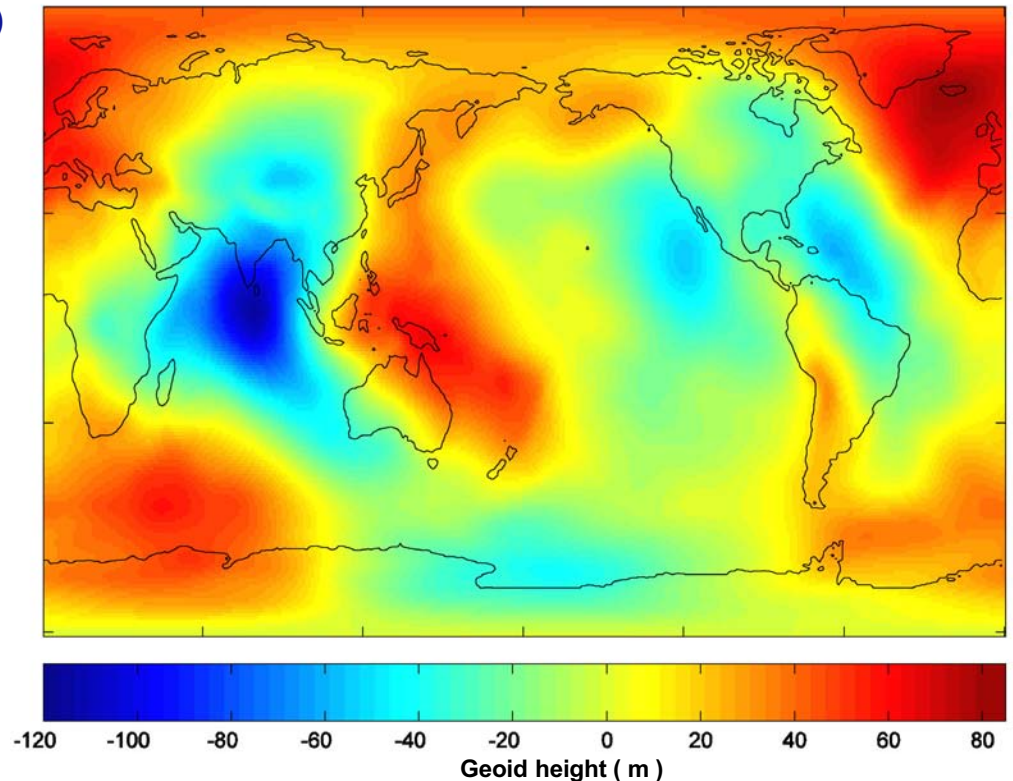

The geoid is the level (constant gravity) surface that best coincides with mean sea level

The geoid height varies by ~200 m, but oceanographic applications need this to be determined to cm accuracy

GRACE Gravity Model Performance

The GRACE models are a dramatic improvement over previous models in the degree range of ~4-90.

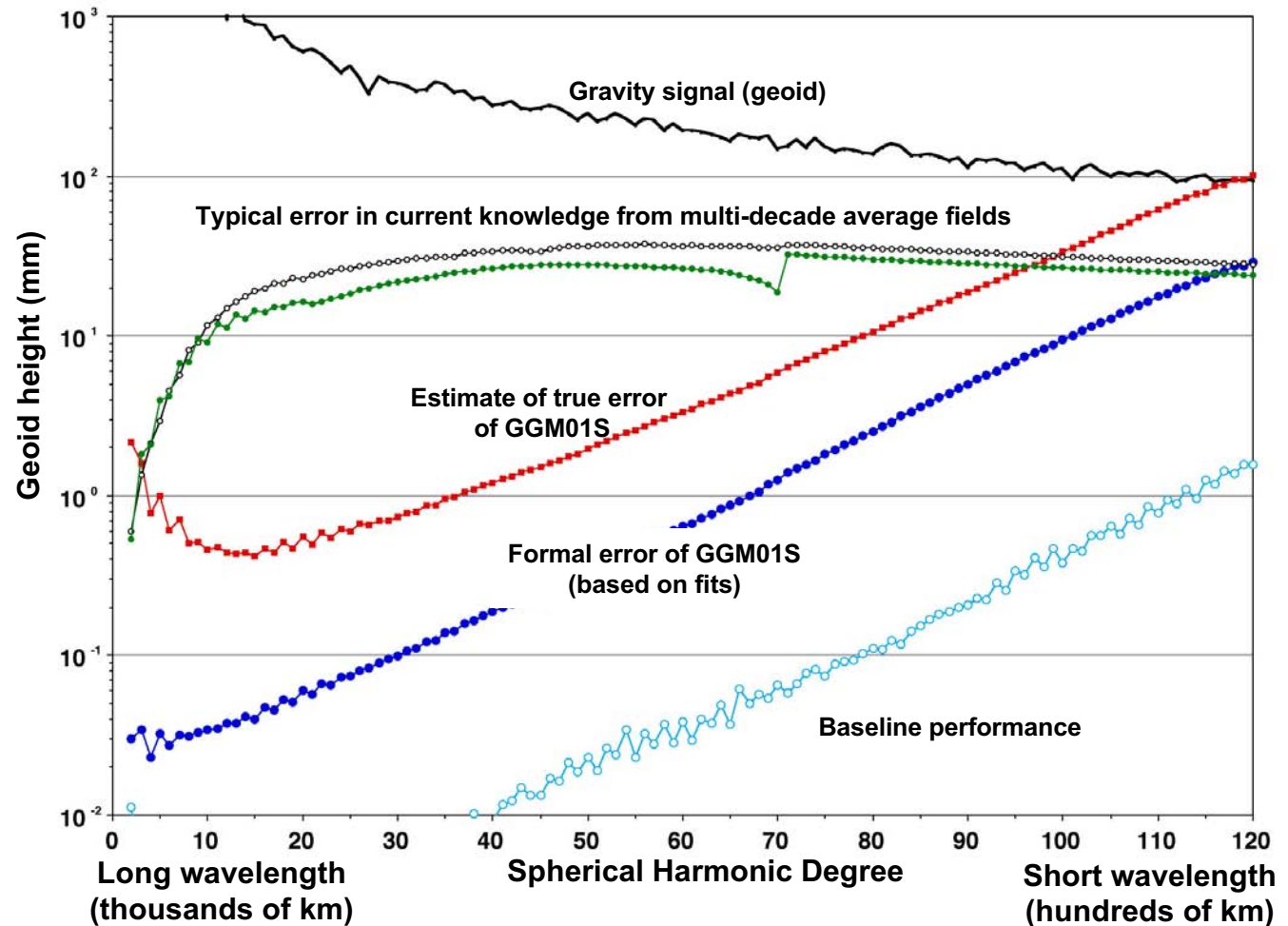

Gravity Solution Regularization

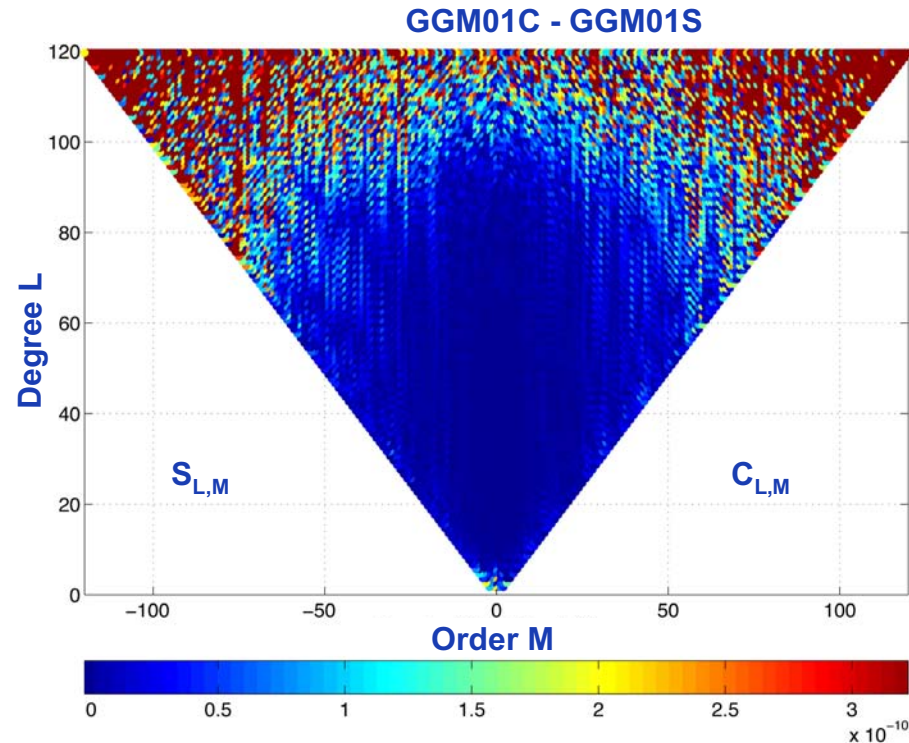

The attenuation due to the satellite altitude causes the coefficients to be less well determined with increasing degree

High-degree 'near-sectorial' coefficients are more weakly determined and more susceptible to data and modeling errors, leading to the need for regularization of some kind

GRACE Gravity Model Performance

The GRACE models are a dramatic improvement over previous models in the degree range of ~4-90.

Work remains to reduce the formal errors to the baseline level, and to reduce the true errors closer to the formal errors.

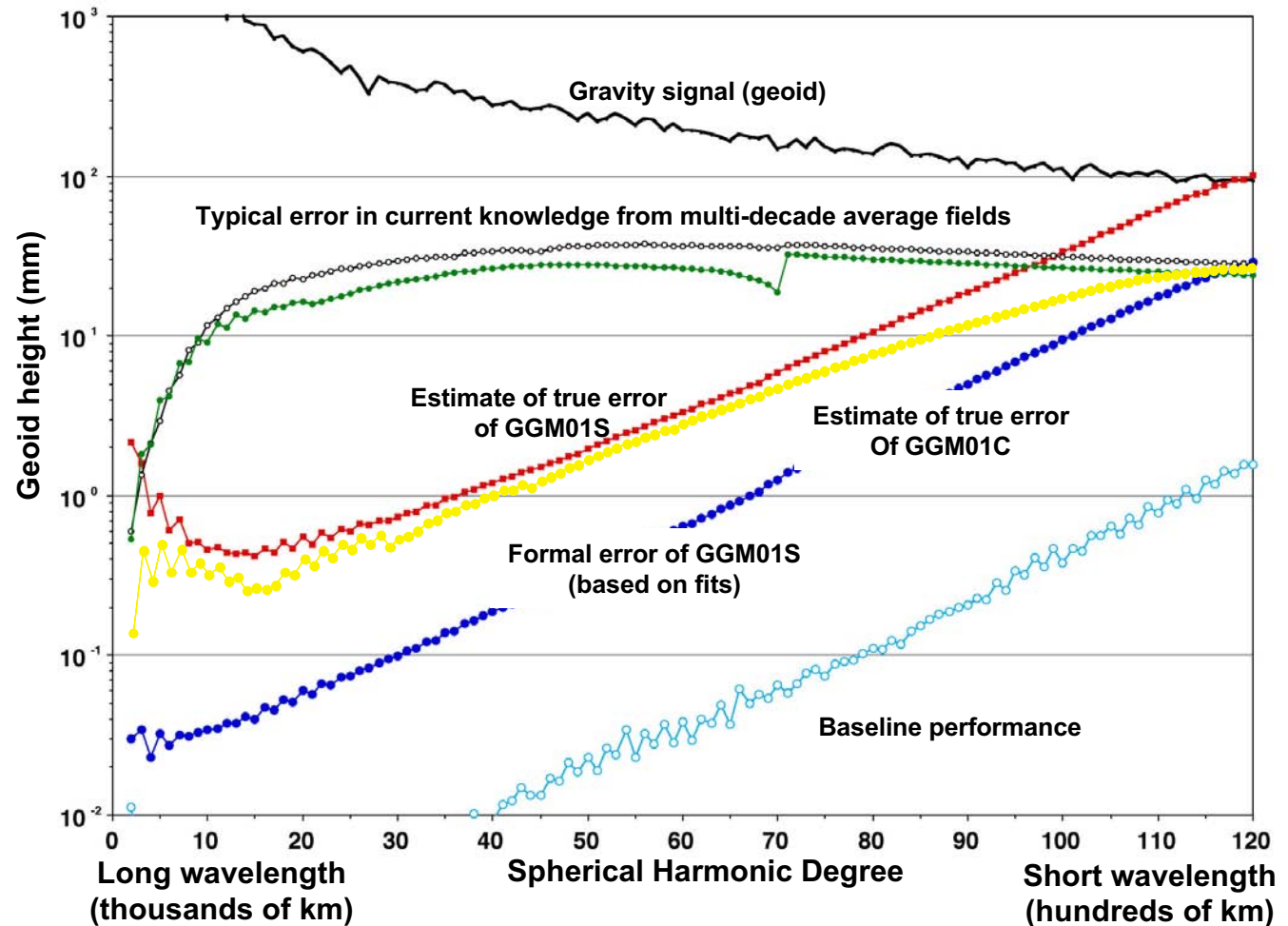

Progress in GRACE Gravity Solutions

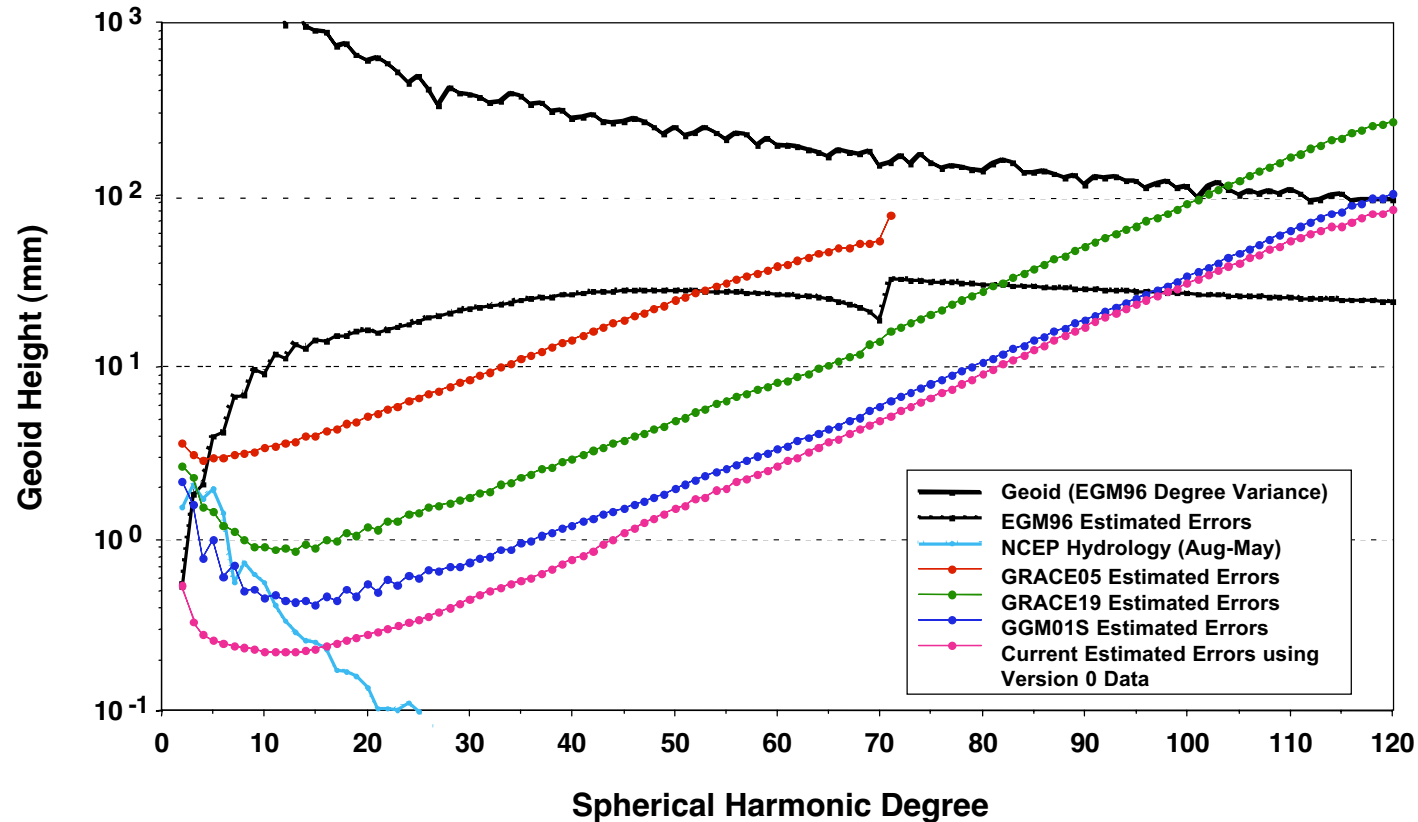

- As Level-1 and Level-2 processing techniques have improved, the errors have been reduced.
- Low degree error estimates for GGM01S, based on subset solutions, were probably reflecting real signal, not error, and thus may have been pessimistic there.
- Newest error estimate suggested by independent solutions for the same month of data.

Gravity Errors Predicted by Full Covariance

Geoid errors from GRACE are much more uniform, without land/sea discrimination

Predicted geoid height errors for EGM96*

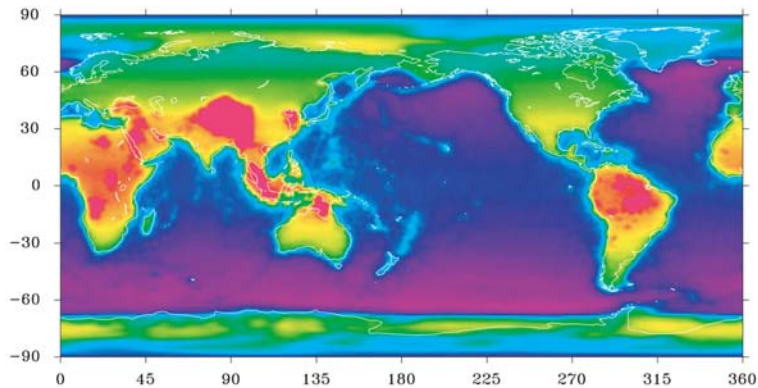

Errors as large as 38 cm

Predicted gravity anomaly errors for TEG4**

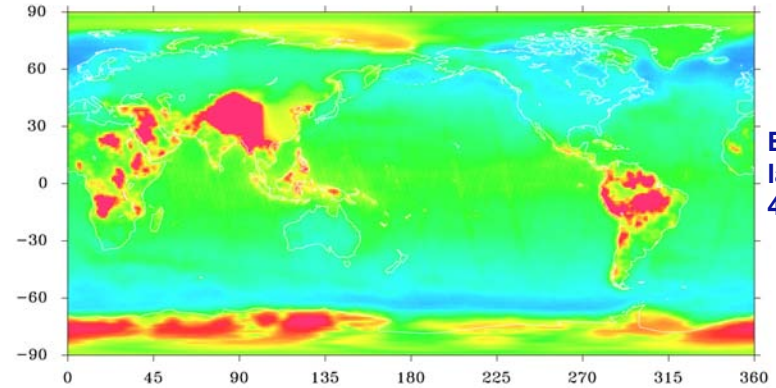

Errors as large as 4.4 mgal

Predicted geoid height errors for GGM01S*

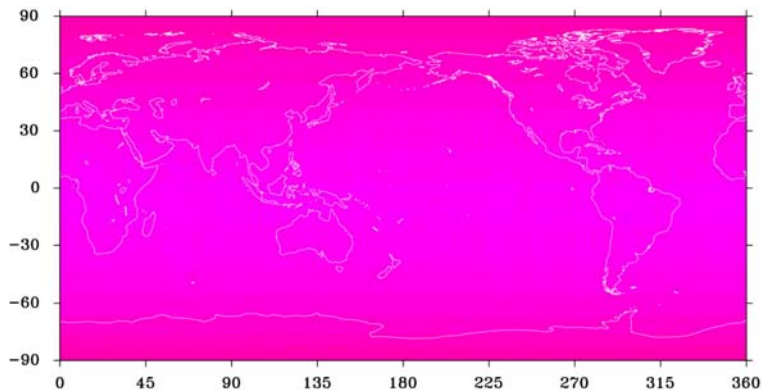

Errors less than 2 cm

Predicted gravity anomaly errors for GGM01S**

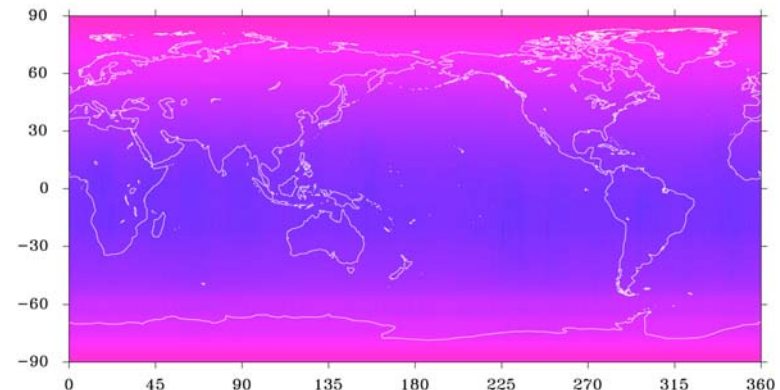

Errors less than 0.8 mgal

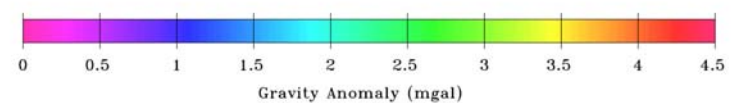
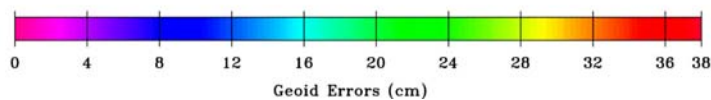

* at ~300 km resolution (degree/order 70)

** at ~220 km resolution (degree/order 90)

Simulated Error Realizations from Calibrated Covariance

Examples of how gravity coefficient errors would tend to manifest themselves in geoid height or equivalent water thickness

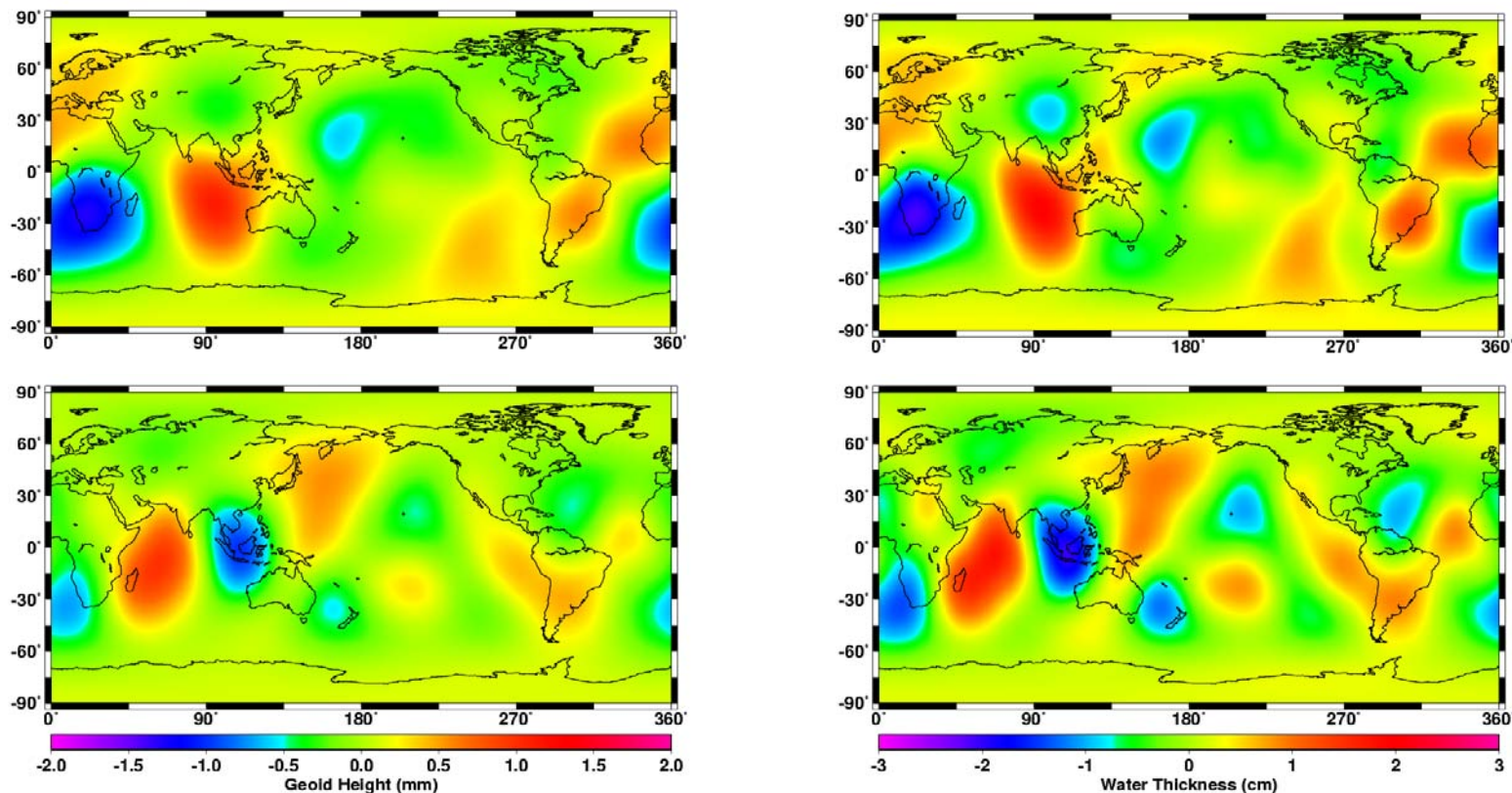

Geoid height anomaly (mm)
 J_2 removed, 2000 km smoothing

Degree 90 Banded GPS Leveling Test

Rather than patching the GRACE models with EGM96 out to 360x360 to perform comparisons with GPS leveling data, the portion of the geoid below degree 90 is isolated for testing.

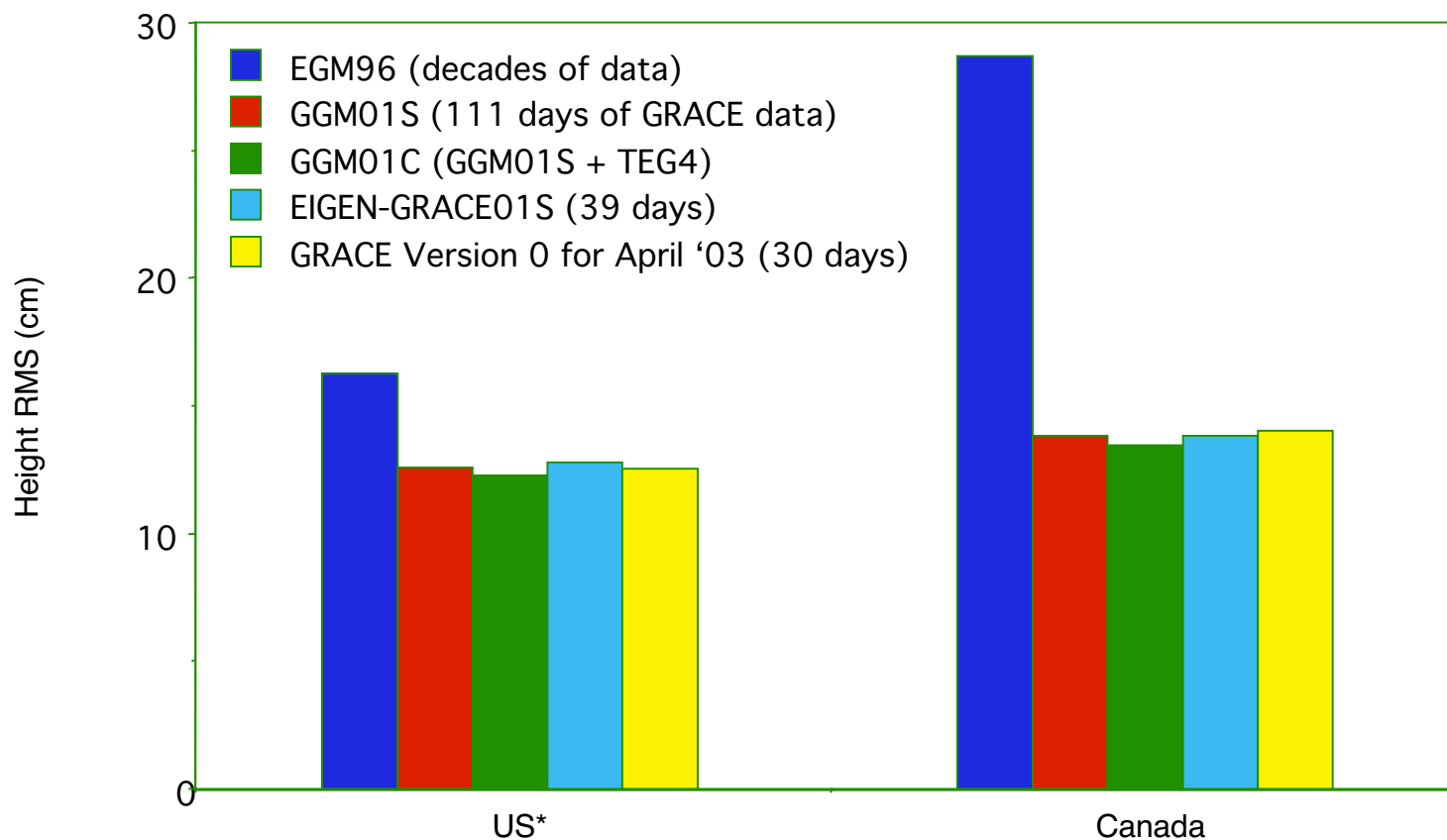

* The mean for each state has been removed; considerable variation in the mean from state to state was observed. A global geoid from GRACE accurate to the sub-cm level at the long wavelengths will help in identifying biases in local geoid models.

Geostrophic Currents Test

Standard Deviation wrt Levitus* (cm/s)

Model	Zonal	Merid.
EGM96	6.9	4.8
GGM01S	2.6	3.0
GGM01C	2.6	2.9
GFZG1S	2.6	3.0
Aug '02	2.6	3.1
Apr '03	2.6	3.2
May '03	2.6	3.0

* Topography map determined from World Ocean Atlas 2001 (WOA01) data relative to 4000 m (courtesy of V. Zlotnicki)

GGM01S used no conditioning of any kind

GGM01C included terrestrial information from TEG4

GFZG1S (= EIGEN-GRACE01S) used weak 'Kaula constraint'

New monthly solutions using Version 0 of Level-1b data

Comparison of zonal and meridional ocean currents implied by mean sea surface (CSRMSS98) minus various geoid models

The zonal tests appear to have run into the limitations of the test data (MSS or Levitus)

The meridional tests are sensitive to the quality of the 'near sectorials' and continue to be a useful probe into the quality of the gravity solutions

Correlation with Levitus*

Geoid	Zonal	Merid.
EGM96	0.45	0.36
GGM01S	0.93	0.52
GGM01C	0.93	0.55
GFZG1S	0.93	0.53
Aug '02	0.93	0.50
Apr '03	0.93	0.48
May '03	0.93	0.51

Satellite Orbit Comparisons

GRACE solutions have no other satellite information included yet perform better than models tuned with these satellites

Gravity Model	Starlette SLR (cm)	Stella SLR (cm)	Lageos-1 SLR (cm)	Lageos-2 SLR (cm)	ICESat	
					GPS DD (cm)	SLR * (cm)
JGM-3	4.3	6.4	0.96	1.01	1.74	5.5
EGM96	3.7	6.4	1.01	1.01	1.73	9.7
GGM01S	2.8	3.3	1.25	1.29	0.97	1.9
GGM01C	3.6	2.6	1.01	0.98	0.97	2.0
GFZG1S	2.9	3.9	0.90	0.95	0.97	1.9
CSR Aug 02	3.1	3.3	0.90	0.85	0.97	2.0
CSR Apr 03	2.9	3.2	0.90	0.84	0.97	1.8
CSR May 03	2.8	3.2	0.88	0.89		

New monthly solutions using Version 0 Level-1b data

* not used in orbit solution

Predicted Radial Orbit Error for Starlette by Order

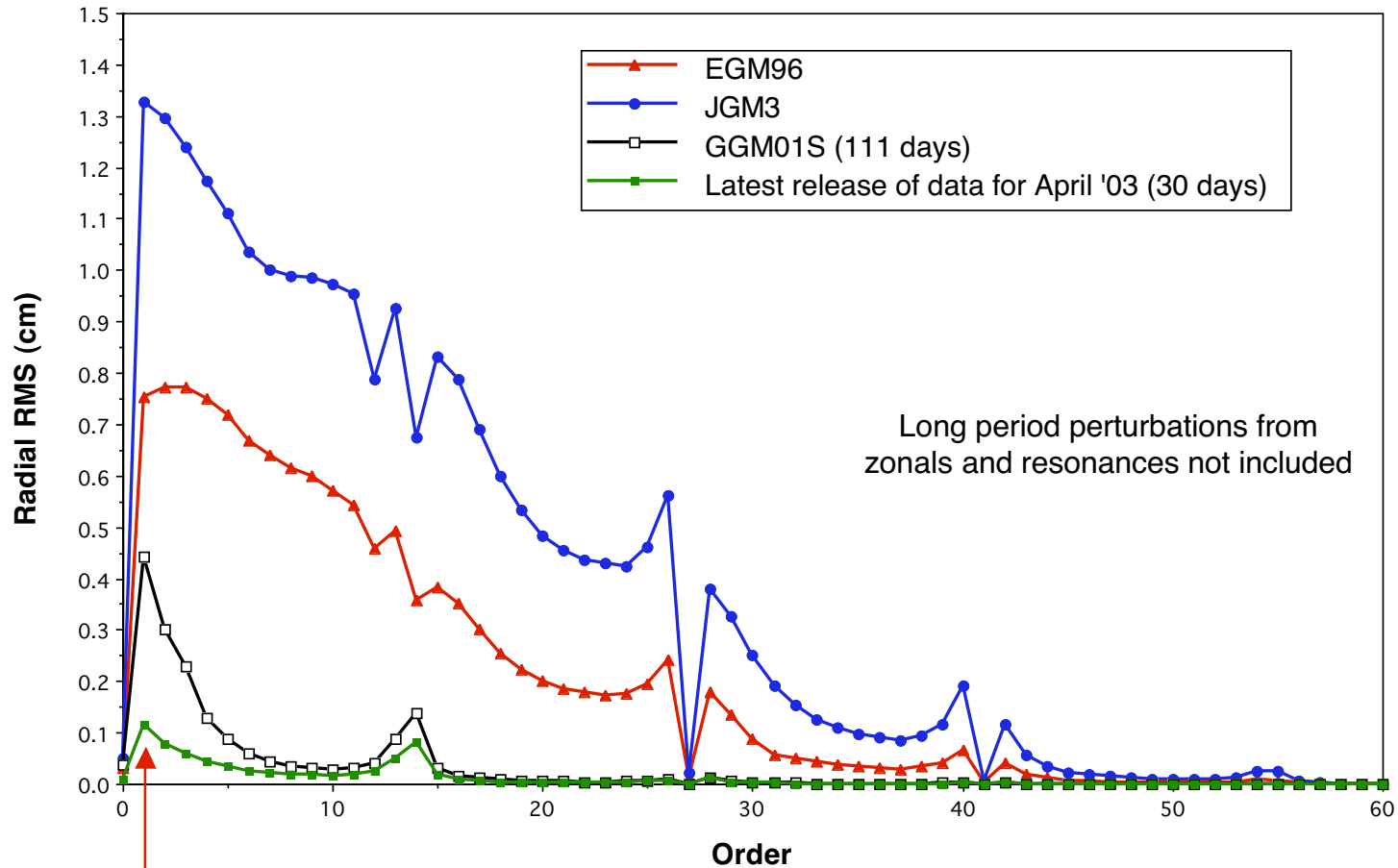

Order 1 is dominant source of 'geographically correlated orbit error' which will most strongly affect geodetic results such as station positioning or altimeter measurements of sea level

Improvements to Geodetic Results Using a GRACE Gravity Model

Discrepancy between station positions determined with DORIS (using lower altitude satellites) and with GPS is dramatically reduced; problem stations much more clearly visible now.

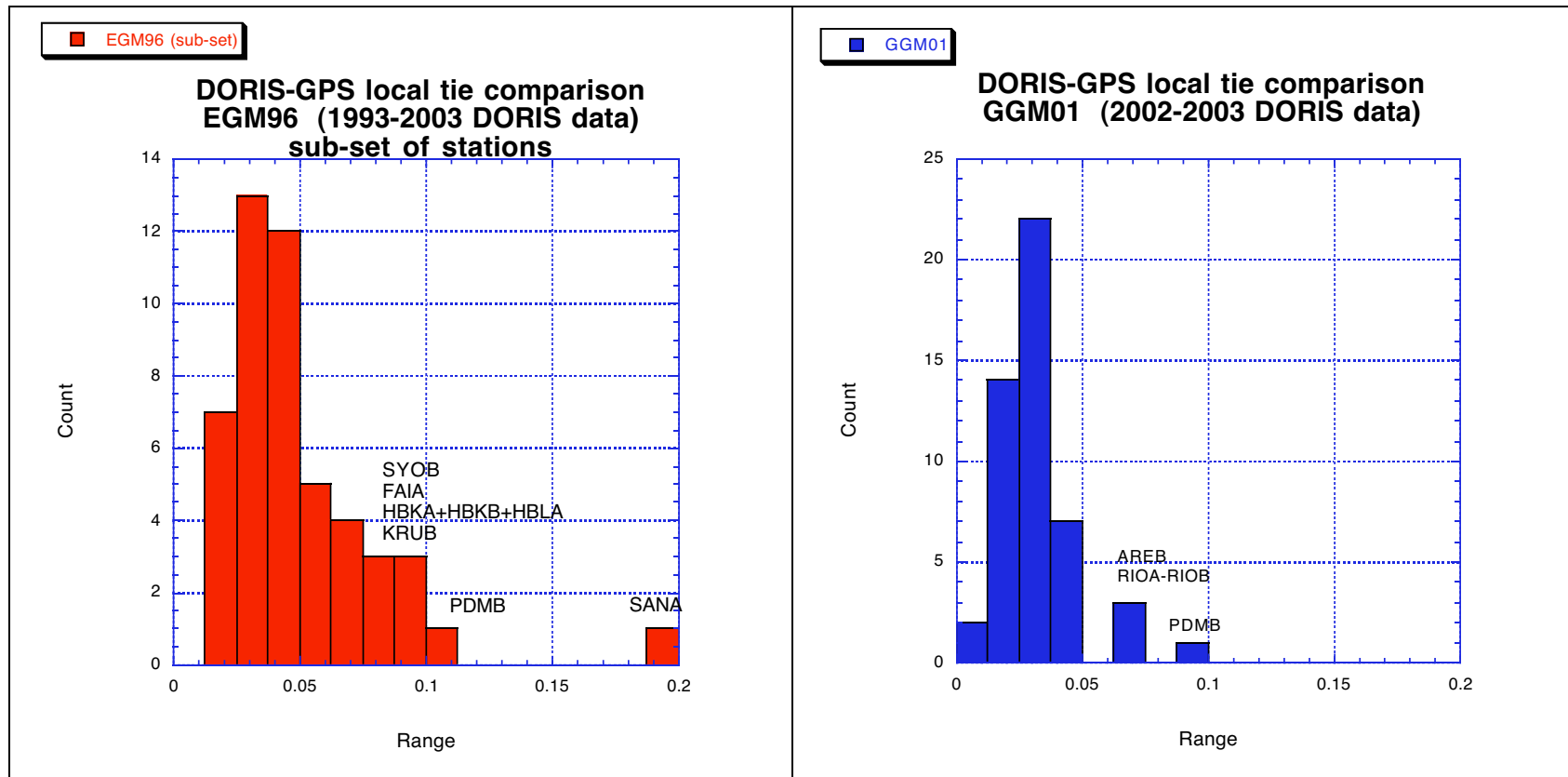



GRACE Gravity Field Recovery at GFZ Potsdam

R. Schmidt, F. Flechtner, R. König, U. Meyer,
K.-H. Neumayer, Ch. Reigber, P. Schwintzer, S. Y. Zhu

**GeoForschungsZentrum Potsdam (GFZ)
Department 1 Geodesy & Remote Sensing**

Joint US/European GRACE Science Team Meeting (GSTM),
Oct. 8 - 10, 2003, Austin/Texas, USA





Dynamic Gravity Field Recovery for GRACE



Method

- Gravity recovery based on dynamically restituted orbits.

Observables

- High-low GPS SST from the onboard GPS BlackJack receivers.
- μm -precise low-low K-Band SST (range-rate measurements, KRR).
- Non-conservative forces via precise onboard accelerometry.
- Spacecraft orientation in inertial space from onboard star cameras.

2-Step Approach

- Step 1: Determine constellation of GPS sender satellites from GPS ground data.
- Step 2: Introduce GPS sender satellites and clocks in GRACE POD as fixed.





EIGEN-GRACE01S Gravity Model

released on July 25, 2003



Data Coverage

- **39 days** in Aug and Nov 2002 (commissioning phase), i.e. 43 arcs (nominal arc length 1.5 days).

Tracking Data

- **GPS Blackjack SST**, 30s epochs (de-sampled from 10s)
~ 1.5 million code and phase observations.
- **KBR Range-Rate SST**, 5s epochs (de-sampled from 10Hz)
~ 588 000 range-rate observations.

Surface Force Accelerations

- **SUPERSTAR three-axes accelerometer data**, 5s normal points from 10Hz values.

S/C Orientation

- **ASC star camera quaternions** (body-mounted heads), 5s normal points from 10Hz values.





EIGEN-GRACE01S - Processing (I)



Weighting

- GPS code (50 cm), GPS phase (1 cm).
- KBR range-rate ($0.5 \mu\text{m/s}$).

Parameterization of GRACE Normal Equation Systems

Arc-dependent parameters:

- State vectors GRACE-A, GRACE-B per arc.
- Clock offsets GPS receivers GRACE-A, GRACE-B (30 s).
- GPS-SST ambiguities (700 to 800 per 1.5 d arc).
- Accelerometer biases and scale factors per axis.
- KBR instrument nuisance parameters.

Global parameters:

- Static gravity coefficients (see next slide).
- Temporal variable gravity coefficients: drift-rates zonals, time series low degree/order terms.
- Ocean tide constituents.



EIGEN-GRACE01S Parameters

- Static gravitational geopotential complete to degree/order 120 plus selected zonal/sectorial coeff. up to degree 140 (15811 parameters C_{lm} , S_{lm}).
- Temporal variable gravity coefficients (like drift rates or time series) not solved for.
- Ocean tide potential (daily, 1/2-daily) fixed, long-period tides fixed.

Regularization

- In principle not necessary, but regularization according to Kaula's rule as of degree 70 to stabilize solution of shorter wavelengths.

Geographic Coverage Europe

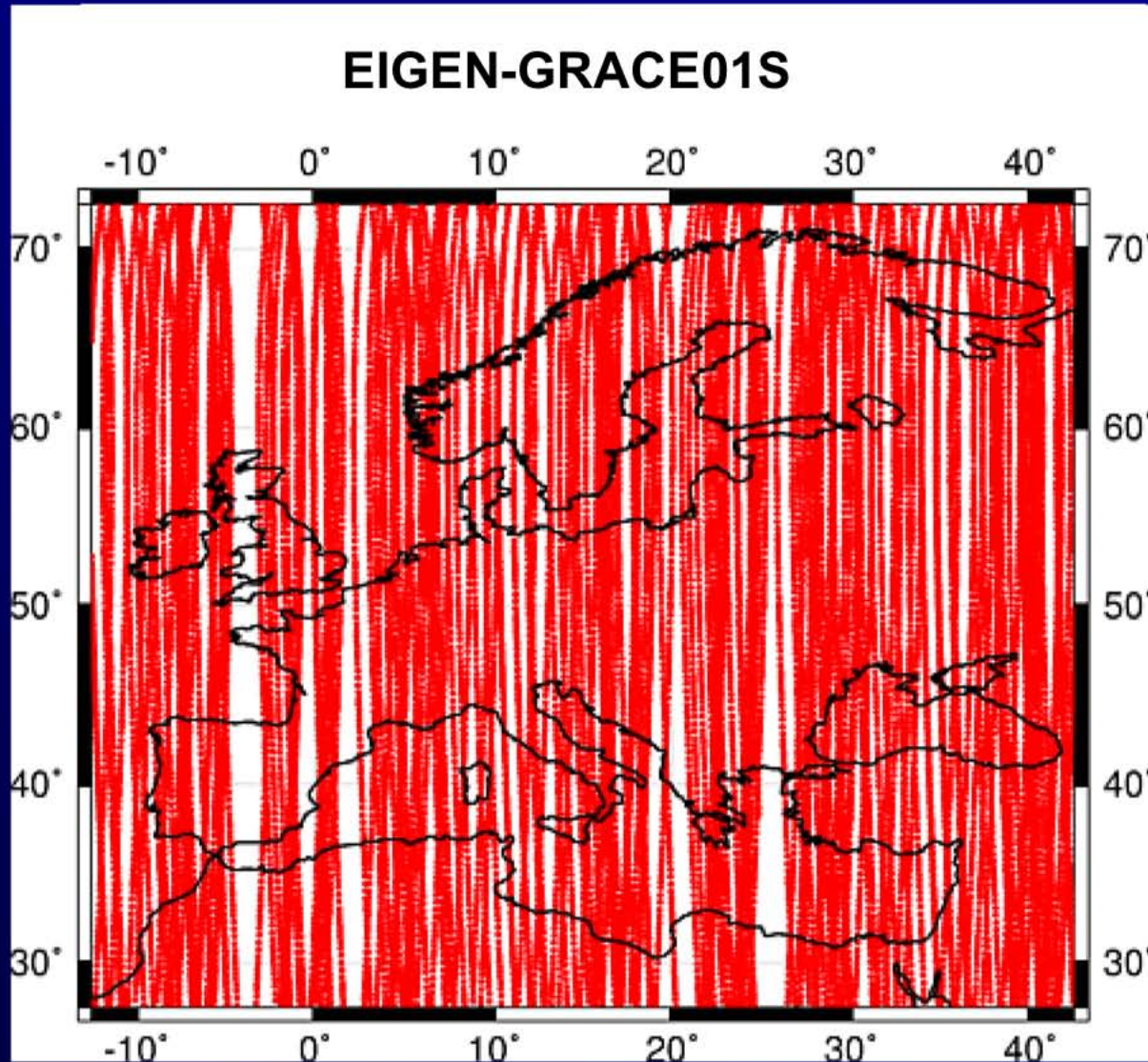

GRACE-only: EIGEN-GRACE01S

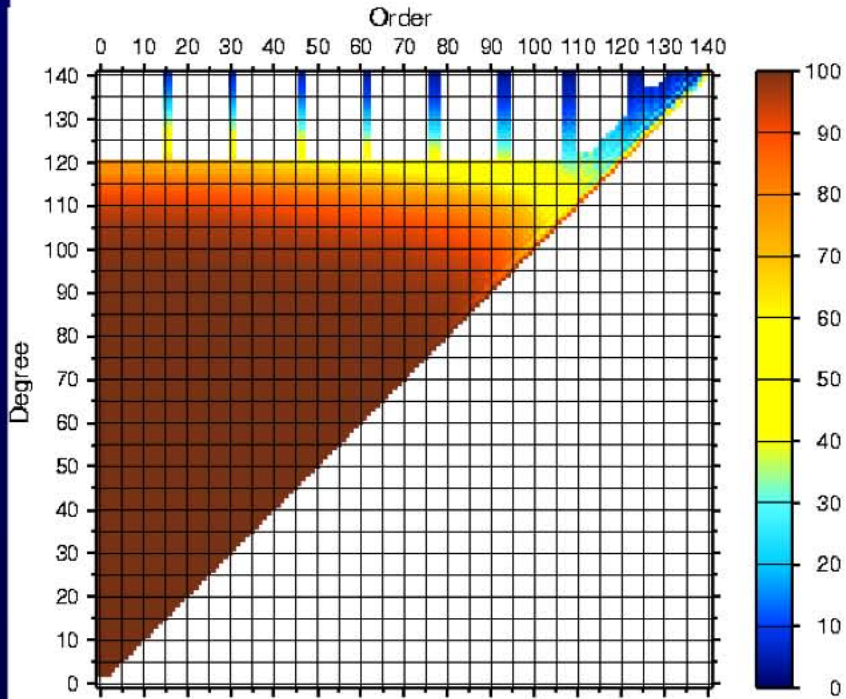

[%] non-stochastic information

CHAMP-only: EIGEN-CHAMP03p

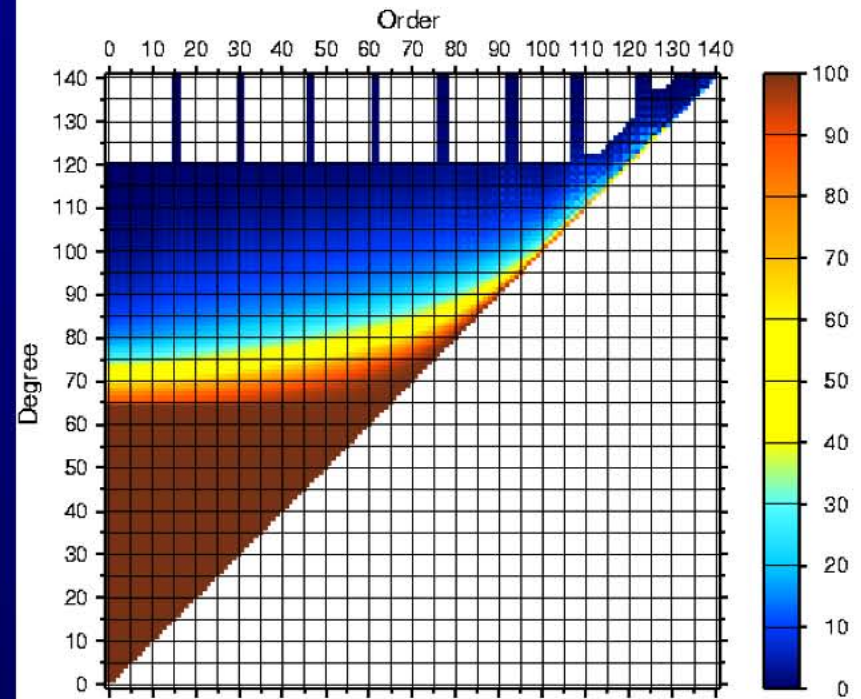

[%] non-stochastic information

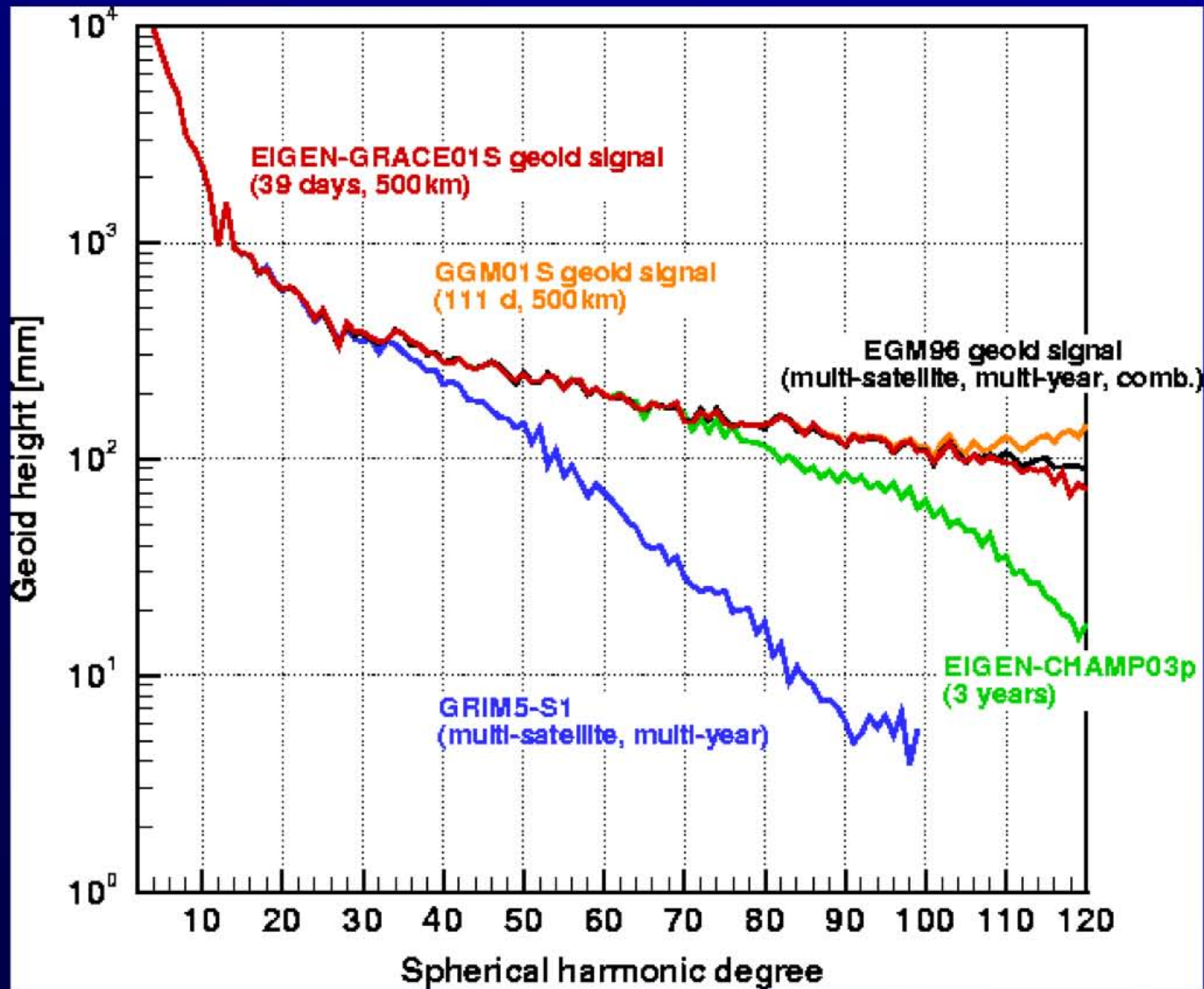

EIGEN-GRACE01S Accuracy

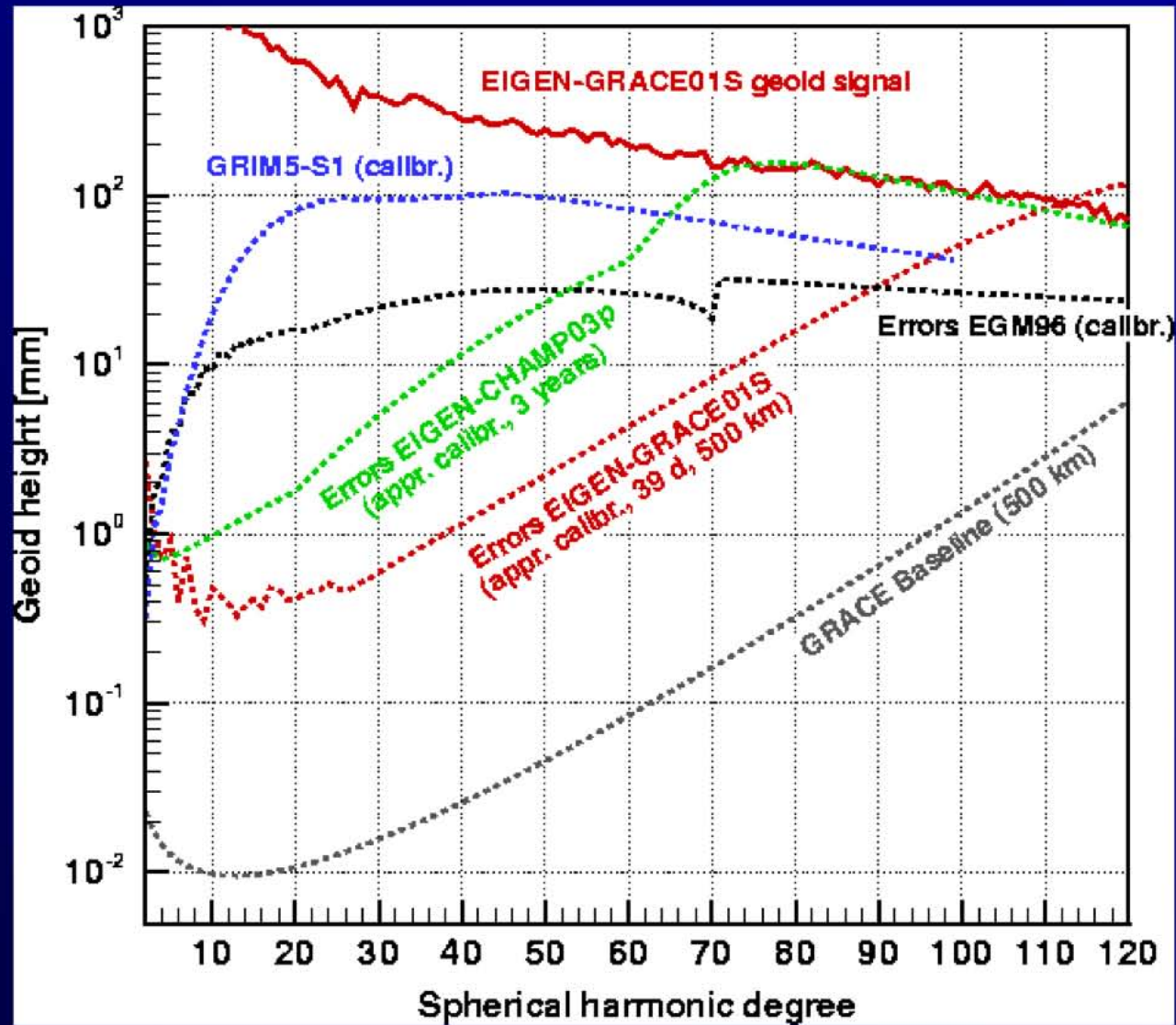

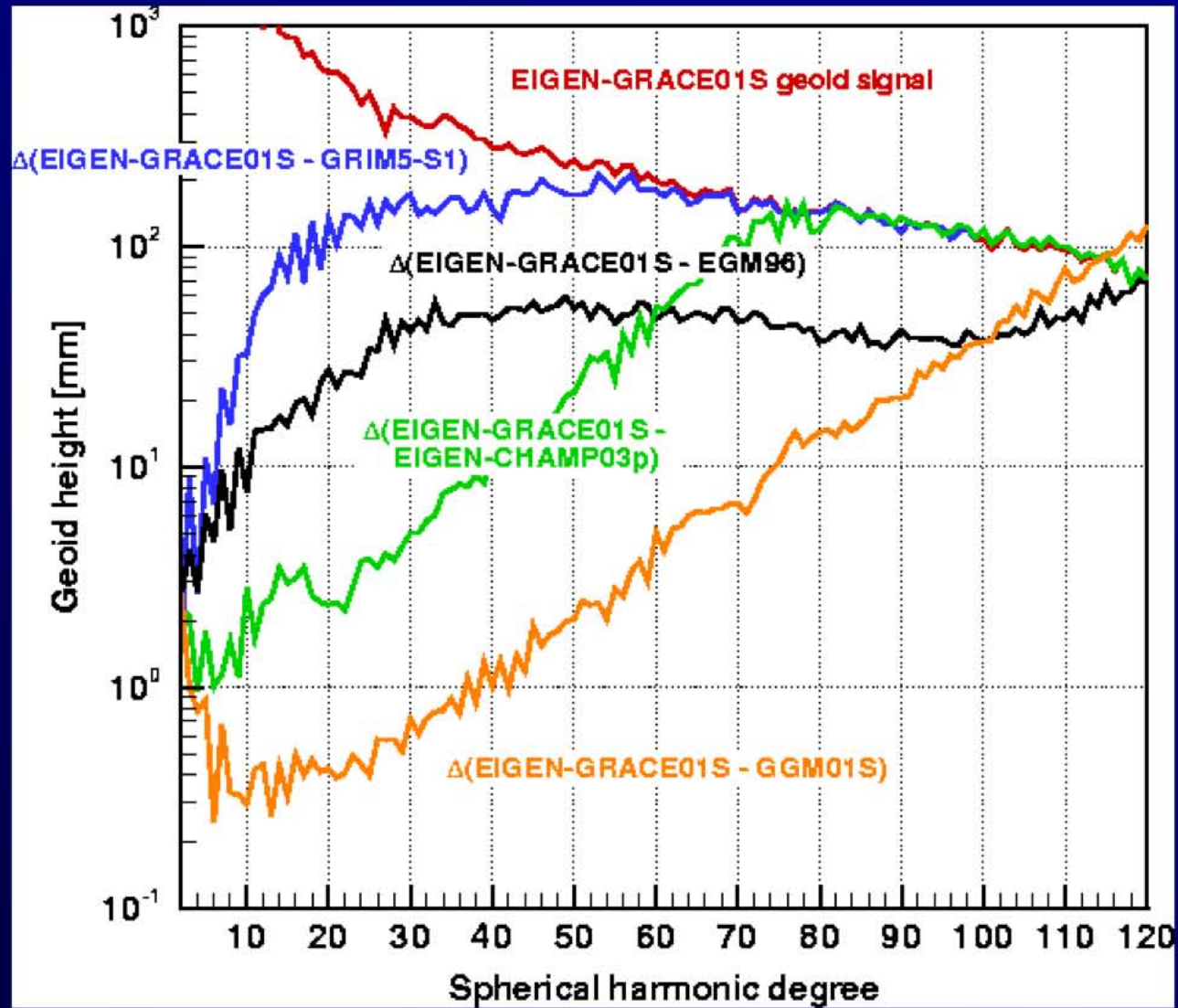

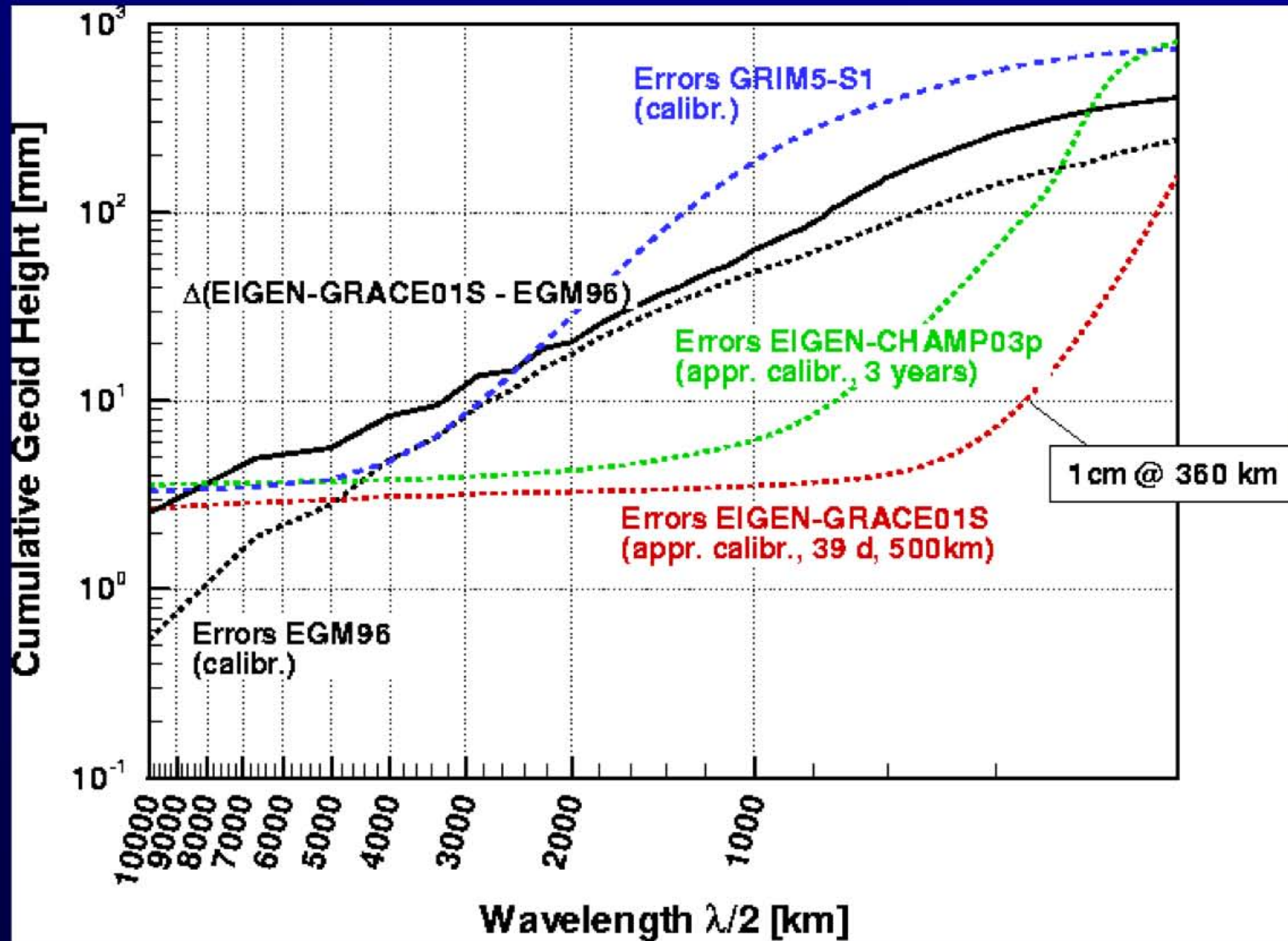

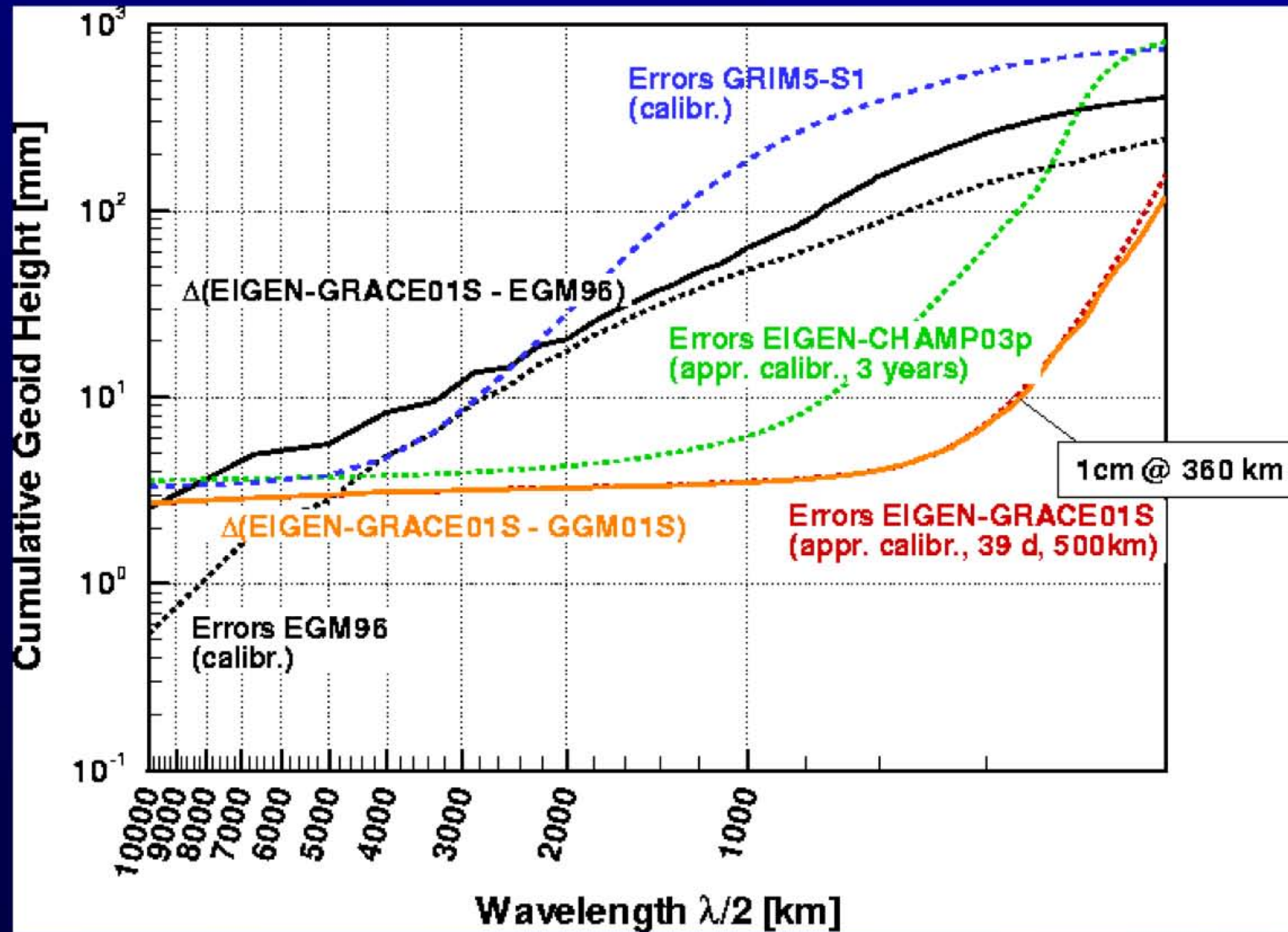



UPDATE: EIGEN-GRACE01S Gravity Model



Data Coverage

- 62 days in Aug, Nov 2002 + April 2003 (add. 23 days)
73 arcs (nominal arc length 1.5 days)

Tracking Data

- **GPS Blackjack SST**, 30s epochs (de-sampled from 10s)
~ 2.5 million code and phase observations
- **KBR Range-Rate SST**, 5s epochs (de-sampled from 10Hz)
~ 960 000 range-rate observations

Surface Force Accelerations

- **SUPERSTAR three-axes accelerometer data**, 5s normal points from 10Hz values

S/C Orientation

- **ASC star camera quaternions** (body-mounted heads), 5s normal points from 10Hz values



EIGEN-GRACE01S

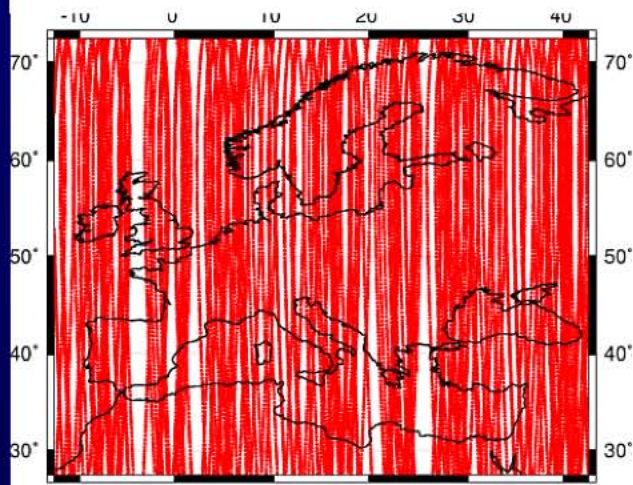

+ April 2003

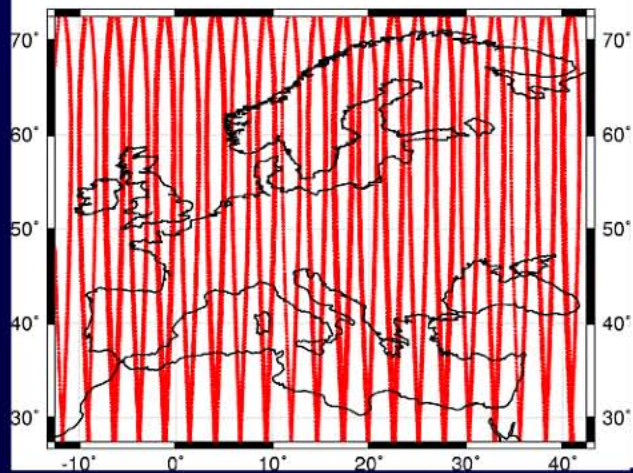

UPDATE: EIGEN-GRACE01S

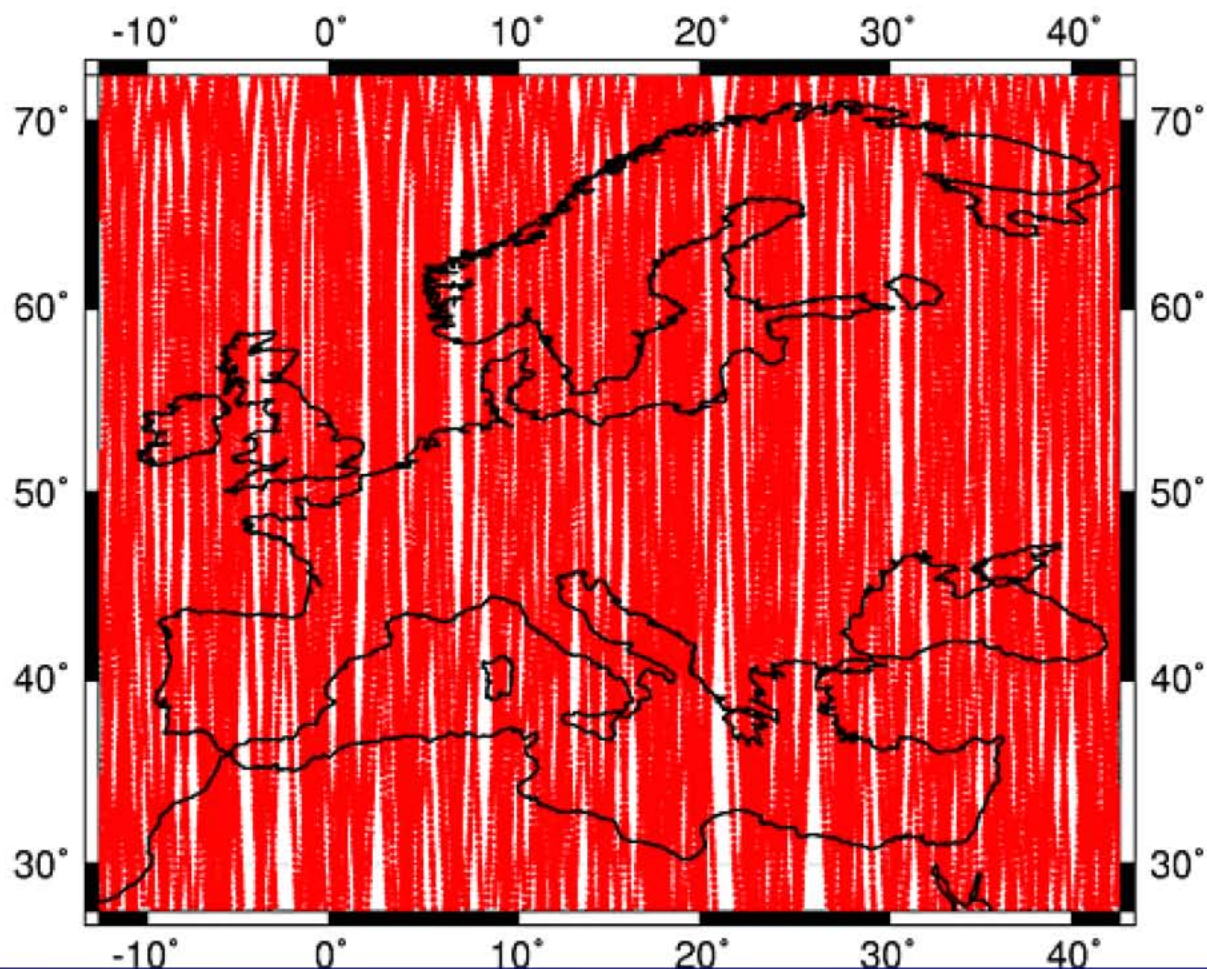

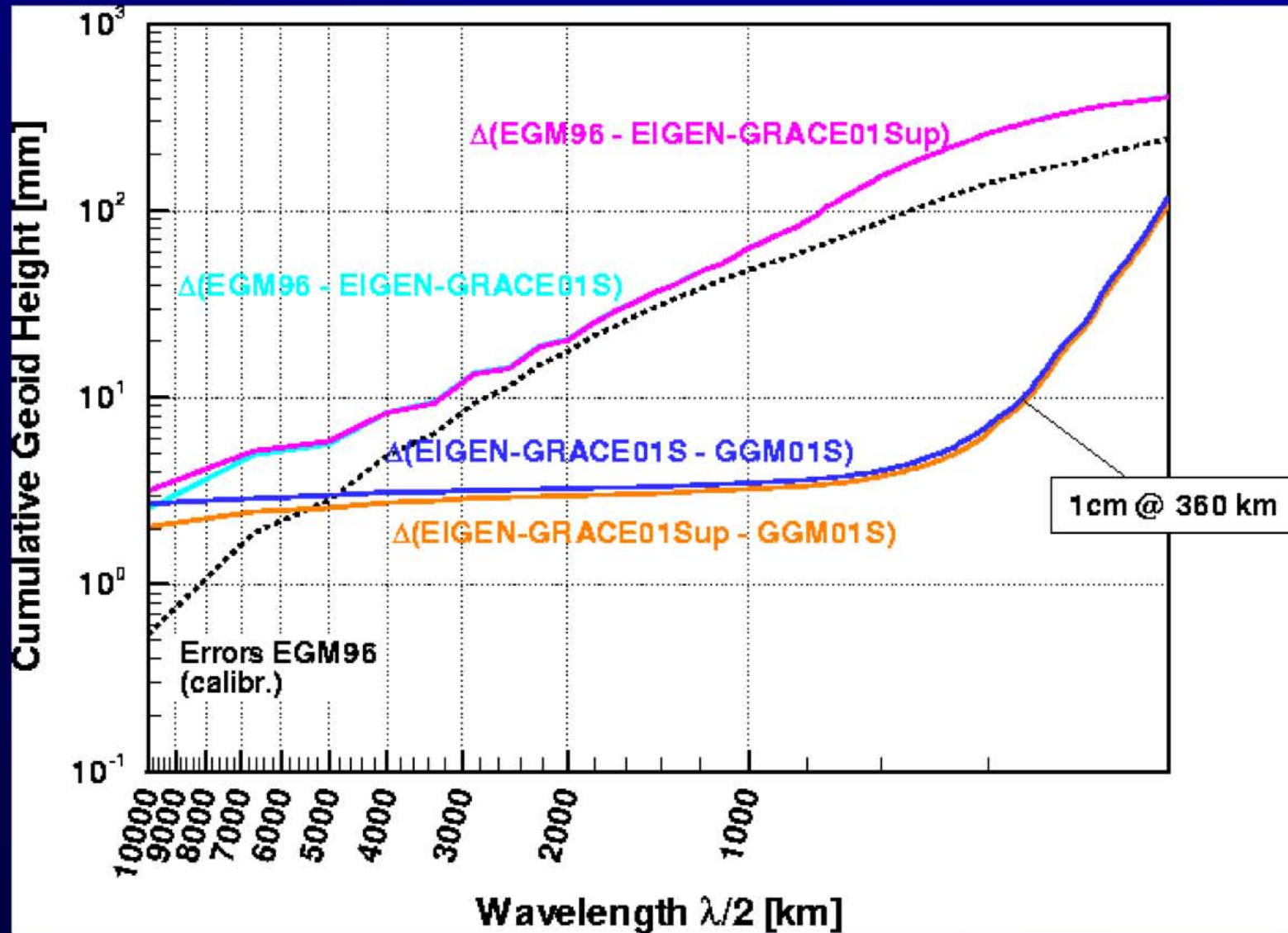



GPS / Levelling (1149 points) minus Canadian Gravimetric Geoid



max. degree used	EGM96	GGM01S	EIGEN- GRACE01S/up	GGM01C
l = 30	15.2	13.7	13.4/12.1	13.5
l = 60	25.9	14.9	14.9/13.7	14.6
l = 90	29.0	14.6	14.1/13.6	13.6
l = 120	31.5	32.9	30.2/24.4	16.1

$(h - H)_{\text{GPS/Lev.}} - N_{\text{Can.Geoid}}$ [cm]

Huang / Véronneau 25/08/2003:
degree-banded Stokes integral method applied for geoid computation





Orbital Fits (SLR) Geodetic Satellites



SLR resp. GPS phase/SLR RMS (CHAMP, GRACE)

Gravity Model	Starlette [cm]	Stella [cm]	Lageos-1/2 [cm]	GFZ-1 [cm]	Ajis [cm]	ERS-2 [cm]	ENVI [cm]	CHAMP [cm]	GRACE [cm]
<i>MultiSatComb</i>									
GRIM5-C1	2.7	3.1	1.11/1.06	14.7	3.3	5.5	4.5	10.4/62	36.4/217
EGM96	3.2	6.7	1.15/1.15	24.7	4.0	9.2	7.1	10.2/81	19.1/70
TEG4*)	3.7	3.4	1.11/1.09	20.5	3.5	5.7	5.3	1.4/14	5.1/28
<i>CHAMP-only</i>									
EIGEN-3p	3.4	6.8	1.15/1.08	13.6	3.4	7.3	15.2	0.6/5.7	2.2/10.1
<i>GRACE</i>									
GGM01S	2.5	3.6	1.13/1.05	14.5	3.3	5.9	6.3	0.6/6.7	1.4/6.7
GGM01C	2.7	3.4	1.11/1.05	13.5	3.5	6.0	4.8	0.6/6.0	1.3/7.5
GRACE01S	2.5	3.5	1.11/1.05	14.5	3.1	5.7	5.2	0.6/6.9	1.2/6.0
GRACE01Sup	2.8	3.2	1.14/1.07	14.1	3.2	5.6	4.6	0.6/6.3	1.2/5.7

*) includes CHAMP data

None of these arcs was used for the CHAMP/GRACE gravity modeling





Conclusions



EIGEN-GRACE01S, EIGEN-GRACE01Sup

- Homogeneous determination of the static gravity field from low-low SST down to a resolution of appr. 200 km (half-wavelength) with unprecedented accuracy. Commissioning error geoid approx. 1 cm at about 360 km half-wavelength.
- Validation against independent terrestrial gravity-related data and orbit data reflects strength and homogeneity of the preliminary GRACE-only solutions.
- Comparable performance of CSR and GFZ solutions.



Future Developments

- Indication that current solution space too small. Will be increased, also in view of the increasing sensitivity due to orbit decaying.
- Processing of longer time series for the recovery of time-variable gravity.
- Develop high resolution combination solutions.
- Investigate/iterate current standards for gravity recovery from GRACE data to further improve results of GRACE gravity field determination (e.g. adopt hydrological de-aliasing product).
- Development/improvement of geodetic/geophysical validation procedures and campaigns for the quality assessment of GRACE-only models (including time-variable gravity) and
- apply GRACE-only models in various fields of Earth Sciences.

Results From Preliminary Time-Varying Fields

Preliminary single-month fields (i.e. C_{lm} , S_{lm} values) for April, 2003 and November, 2002, have been provided by the GRACE Project as part of an early cal/val assessment.

The GRACE Project has already used ECMWF met fields to remove atmosphere, and an ocean model to remove barotropic ocean, before solving for gravity field.

We take the difference between the two monthly fields, and construct smoothed mass fields.

Compare with a prediction of the signal for April, 2003 minus November, 2002, from the sum of:

- (1) soil moisture + surface water: an NCEP (CPC) model (van den Dool, et al, 2003)
- (2) non-barotropic ocean mass variability: the ECCO ocean model minus the barotropic de-aliasing model (Zlotnicki, personal communication).

Degree Amplitudes of Geoid Distribution

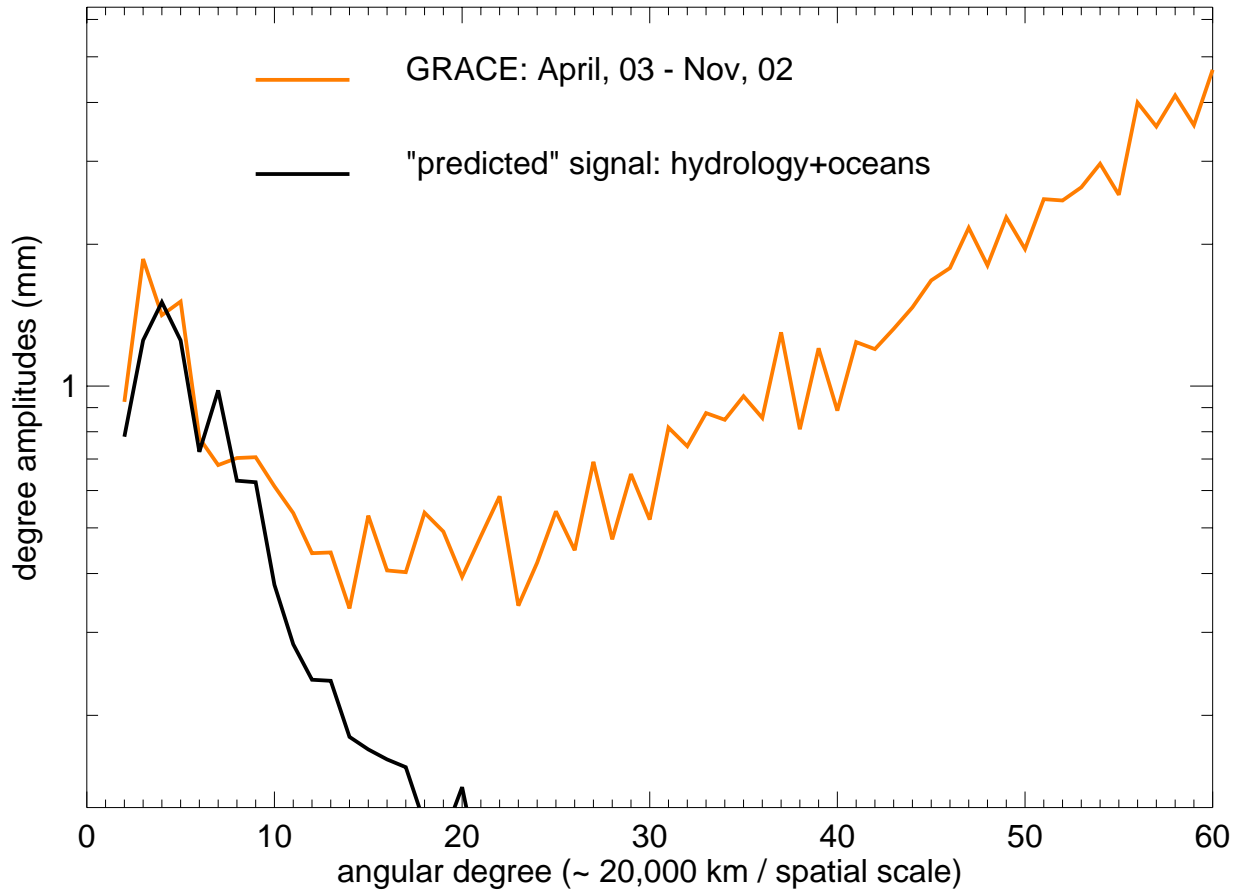

The objective:

Use the preliminary GRACE gravity fields to estimate changes in mass at the Earth's surface.

Compare with predictions.

Represent the gravity field in terms of the geoid shape:

$$\text{Geoid height} = a \sum_{l,m} \tilde{P}_{lm}(\cos\theta)(C_{lm} \cos m\phi + S_{lm} \sin m\phi)$$

The \tilde{P}_{lm} are Legendre functions, a is the Earth's radius.

$$\text{Spatial scale} \approx \frac{20,000}{l} \text{ km.}$$

Take the difference between two monthly GRACE gravity fields.
Use that difference to infer the change in mass integrated vertically through a thin layer at the Earth's surface:

$$\begin{aligned} \sigma(\theta, \phi) &= \int_{\text{surface layer}} \rho(\theta, \phi, z) dz \\ &= \frac{a \rho_{\text{ave}}}{3} \sum_{l,m} \frac{2l+1}{1+k_l} \tilde{P}_{lm}(\cos\theta)(C_{lm} \cos(m\phi) + S_{lm} \sin(m\phi)) \end{aligned}$$

where ρ_{ave} = average density of Earth; k_l = load Love numbers.

Gives noisy results: the C_{lm} 's, S_{lm} 's are inaccurate for large l .

One solution: construct fields that are smoothed estimates of σ .

Smoothing the surface mass estimates

Construct

$$\bar{\sigma}(\theta, \phi) = \int \sigma(\theta', \phi') A(\gamma) \sin\theta' d\theta' d\phi'$$

γ = angle between (θ, ϕ) and (θ', ϕ') ; $A(\gamma)$ = smoothing function.

Equivalent to:

$$\bar{\sigma}(\theta, \phi) = \frac{a \rho_{\text{ave}}}{3} \sum_{l,m} A_l \frac{2l+1}{1+k_l} \tilde{P}_{lm}(\cos\theta) (C_{lm} \cos(m\phi) + S_{lm} \sin(m\phi))$$

$$\text{where } A(\gamma) = \frac{2l+1}{4\pi} \sum_l A_l P_l(\gamma).$$

We use $A(\gamma)$ = Gaussian, with radius = distance between the center of the Gaussian and its half-amplitude point.

GRACE mass estimates; April, 03 -Nov, 02; 2000 km smoothing radius

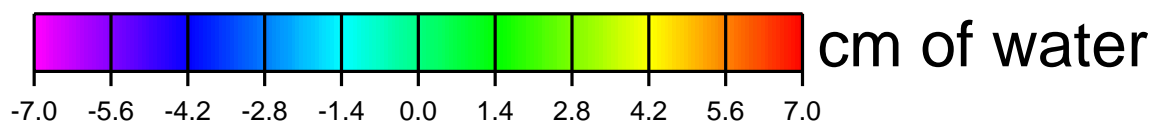
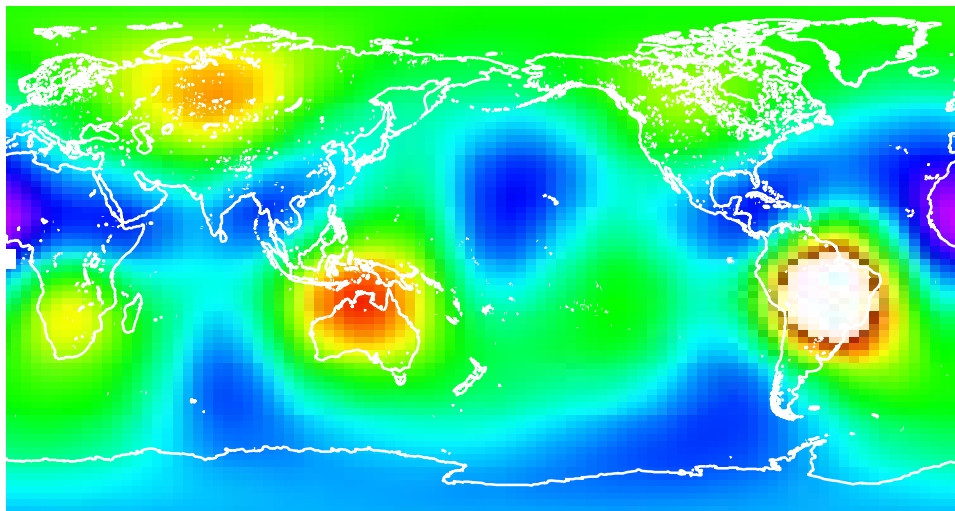

"Predicted" signal: hydrology + oceans

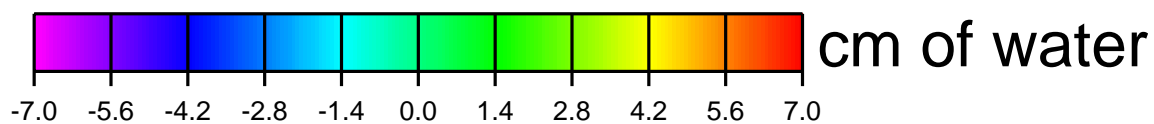
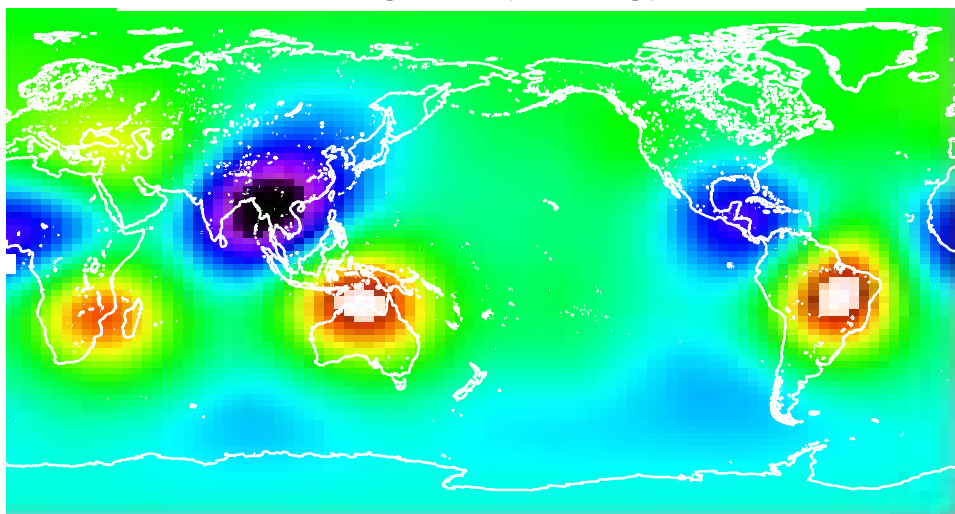

GRACE mass estimates; April, 03 -Nov, 02; 1000 km smoothing radius

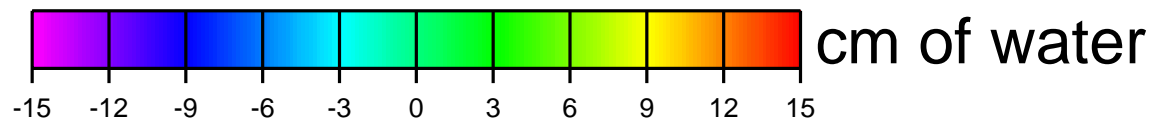
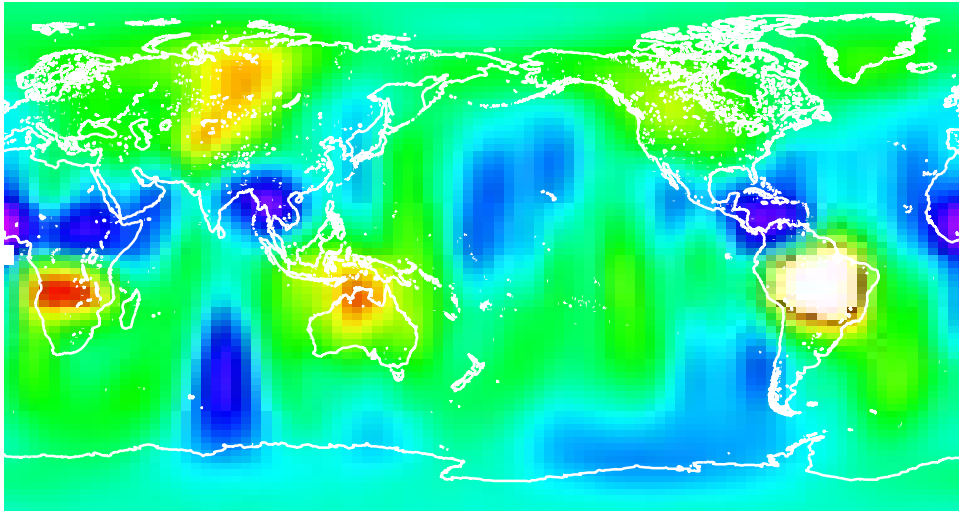

"Predicted" signal: hydrology + oceans

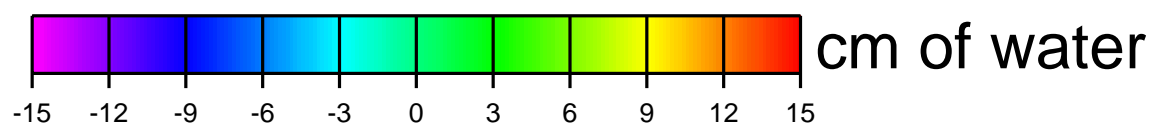
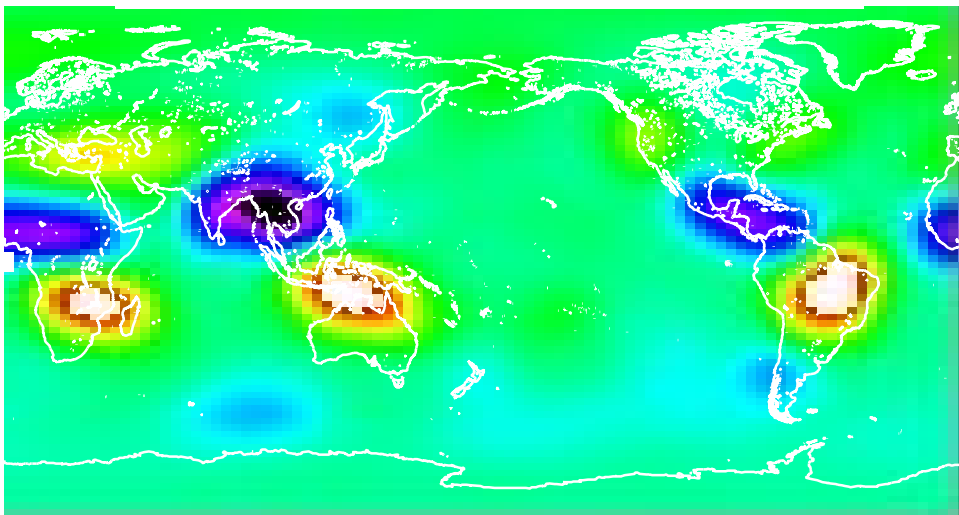

GRACE mass estimates; April, 03 -Nov, 02; 750 km smoothing radius

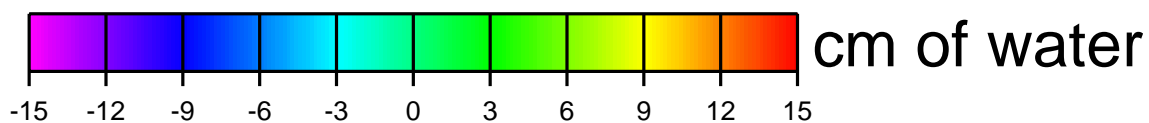
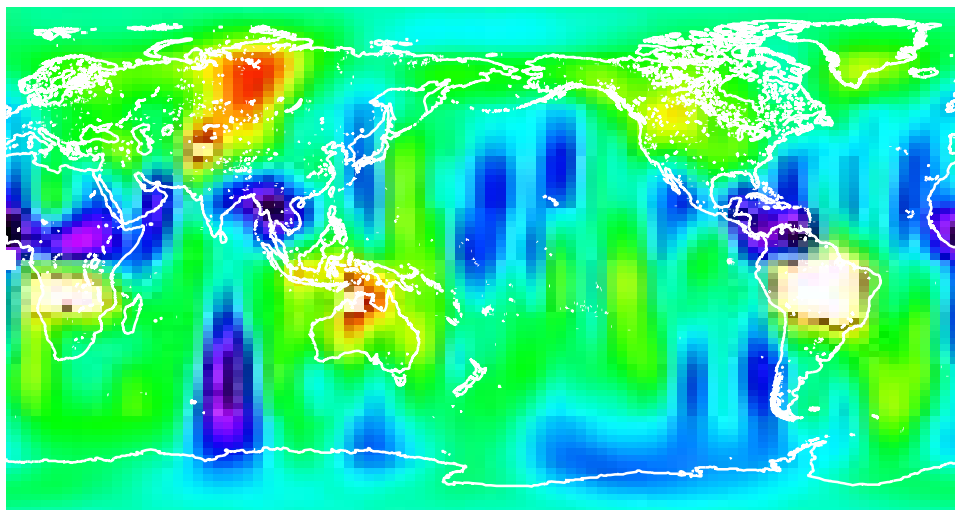

"Predicted" signal: hydrology + oceans

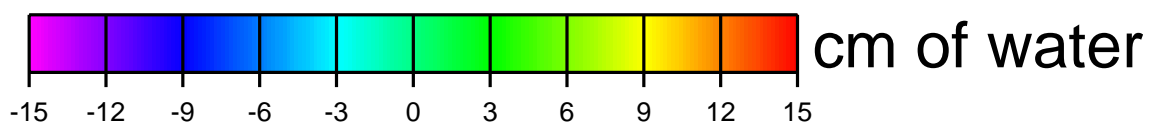
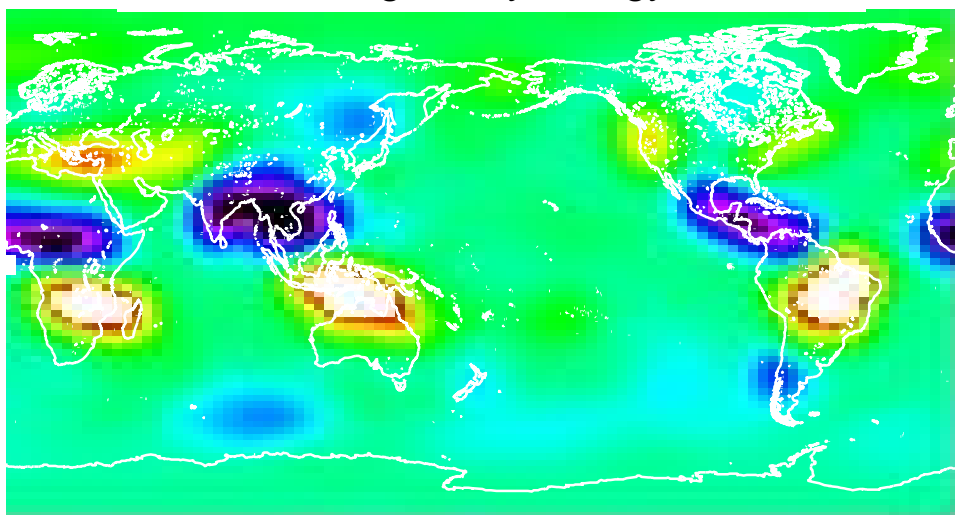

GRACE mass estimates; April, 03 -Nov, 02; 500 km smoothing radius

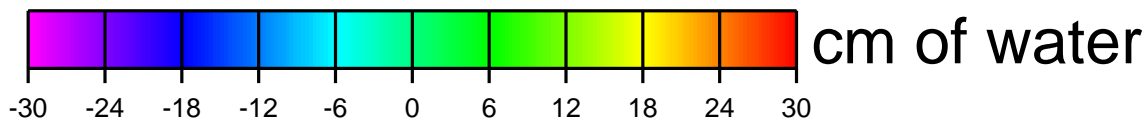
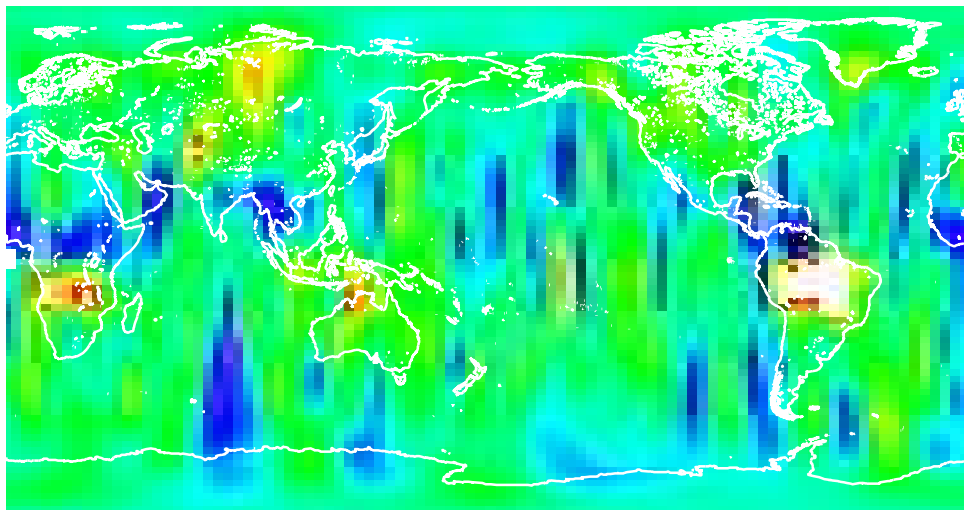

"Predicted" signal: hydrology + oceans

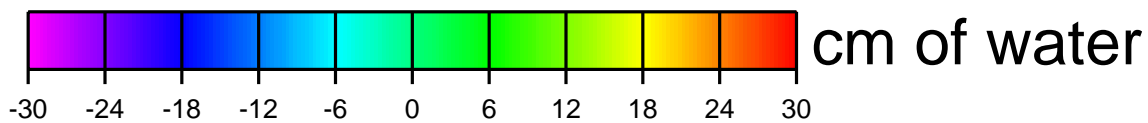
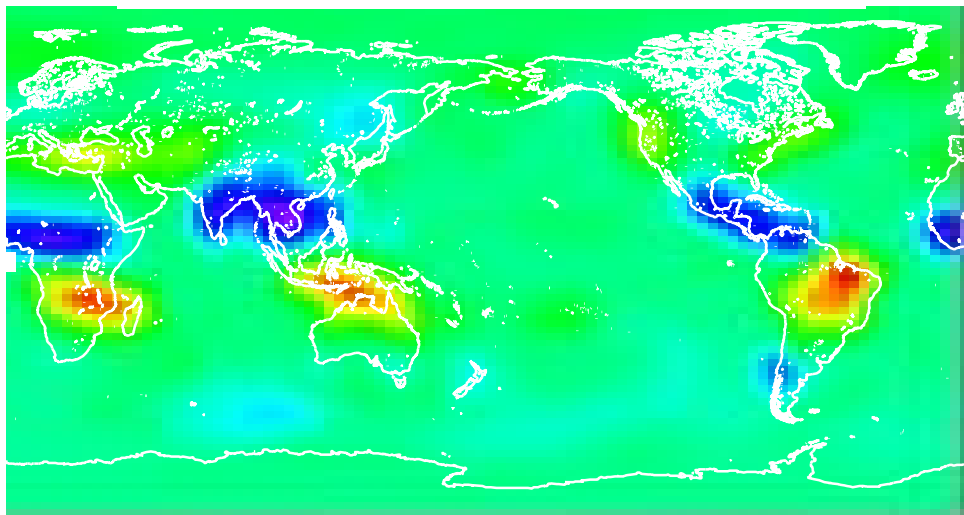

GRACE mass estimates; April, 03 -Aug, 02; 2000 km smoothing radius

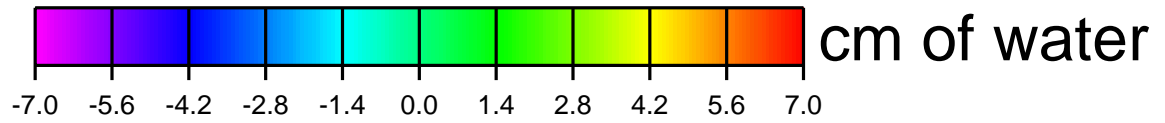
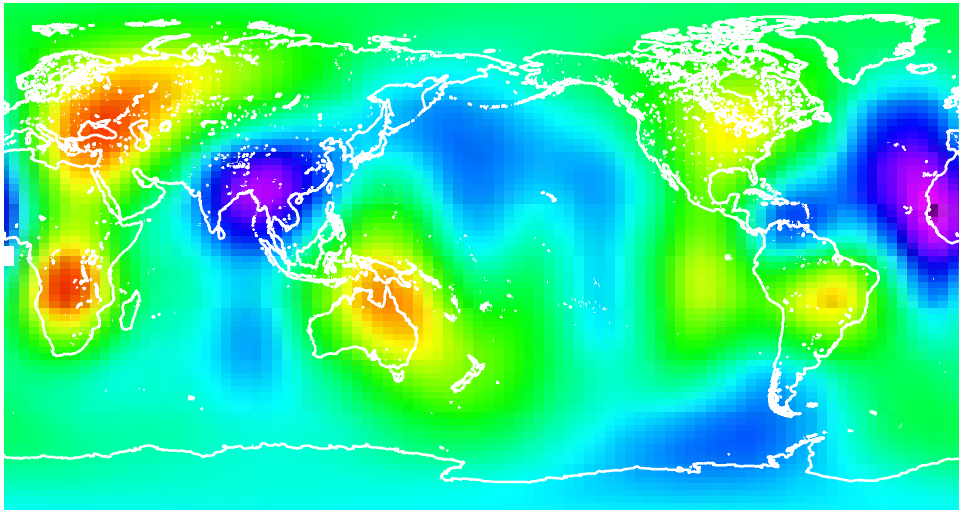

"Predicted" signal: hydrology + oceans

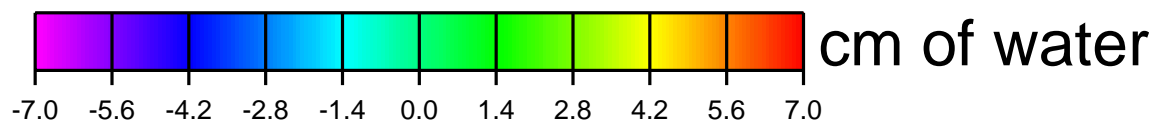
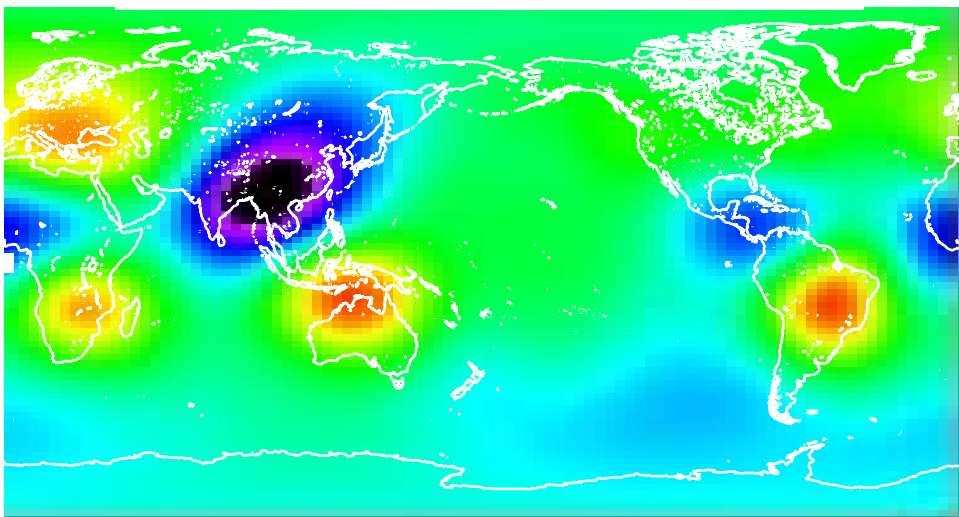

GRACE mass estimates April, 03 -Aug, 02; 1000 km smoothing radius

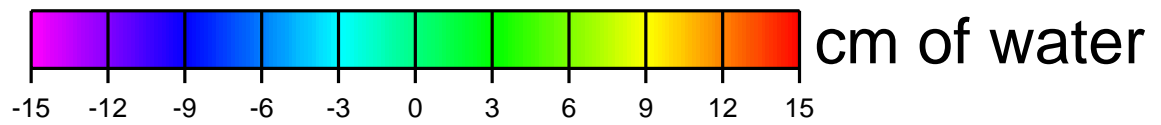
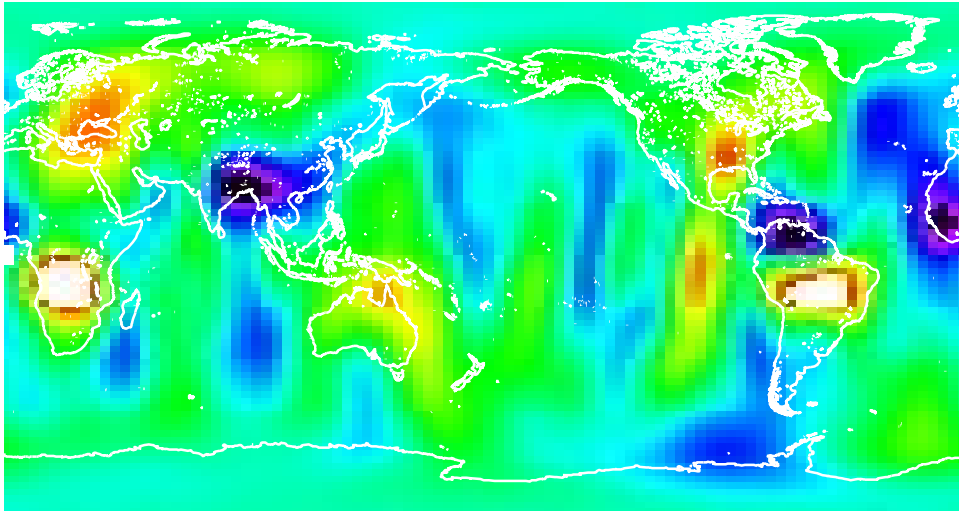

"Predicted" signal: hydrology + oceans

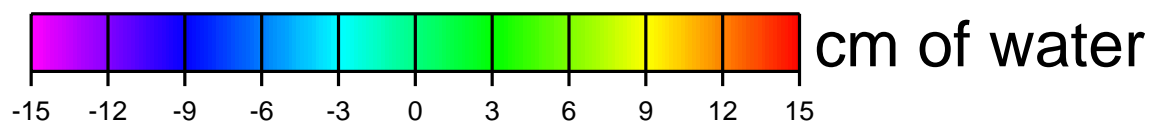
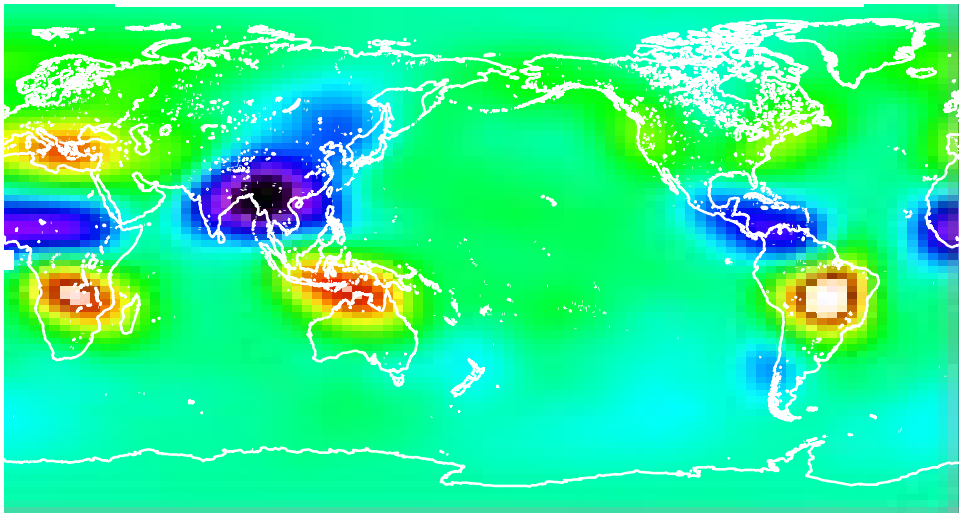

Calibration / Validation of GRACE

M. M. Watkins (JPL)

D. N. Yuan (JPL)

V. Zlotnicki (JPL)

S. Bettadpur and J. Ries (UTCSR)

I. Velicogna (CU)



GRACE Gravity Field Cal/Val

Challenges for GRACE

- Up to 100x improvement beyond pre-GRACE fields
- Large spatial averaging of hundreds of km radius makes comparison with pointwise in situ measurements difficult. In situ results also not always of uniform or (even known) quality.
- Internal precision tests and indirect inference needed to calibrate in absence of definitive external tests
- Some s/c engineering calibrations and alignments need to be determined on orbit for accurate gravity field measuring



Internal Cal/Val (1)

- Compare gravity solutions between CSR, JPL, and GFZ
 - Excellent check of modelling, numerical errors, nuisance parameter choice
- Conduct internal evaluations of gravity solutions within center
 - Month to month variability
 - Orbit fits on other s/c
 - Fit to SLR data
- Time Series/Trend Analysis on Sat-sat residuals
 - Look for signals associated with beta angle and thermocouple data in housekeeping telemetry
- Conduct evaluations of dealiasing models
 - Check power removed from KBR residuals with different atmosphere and ocean models



Compare gravity solutions between CSR, JPL, and GFZ

- Compare
 - orbits
 - residuals
 - gravity fields
 - nuisance parameters
- Under variety of parameterizations including:
 - Data type (Range, range-rate, range acceleration)
 - Choice of kinematic and dynamic nuisance parameterization
 - Numerical integrators and integrator settings (step size, difference table recalculation, etc)



Statistical Comparison of GRACE Gravity Solutions

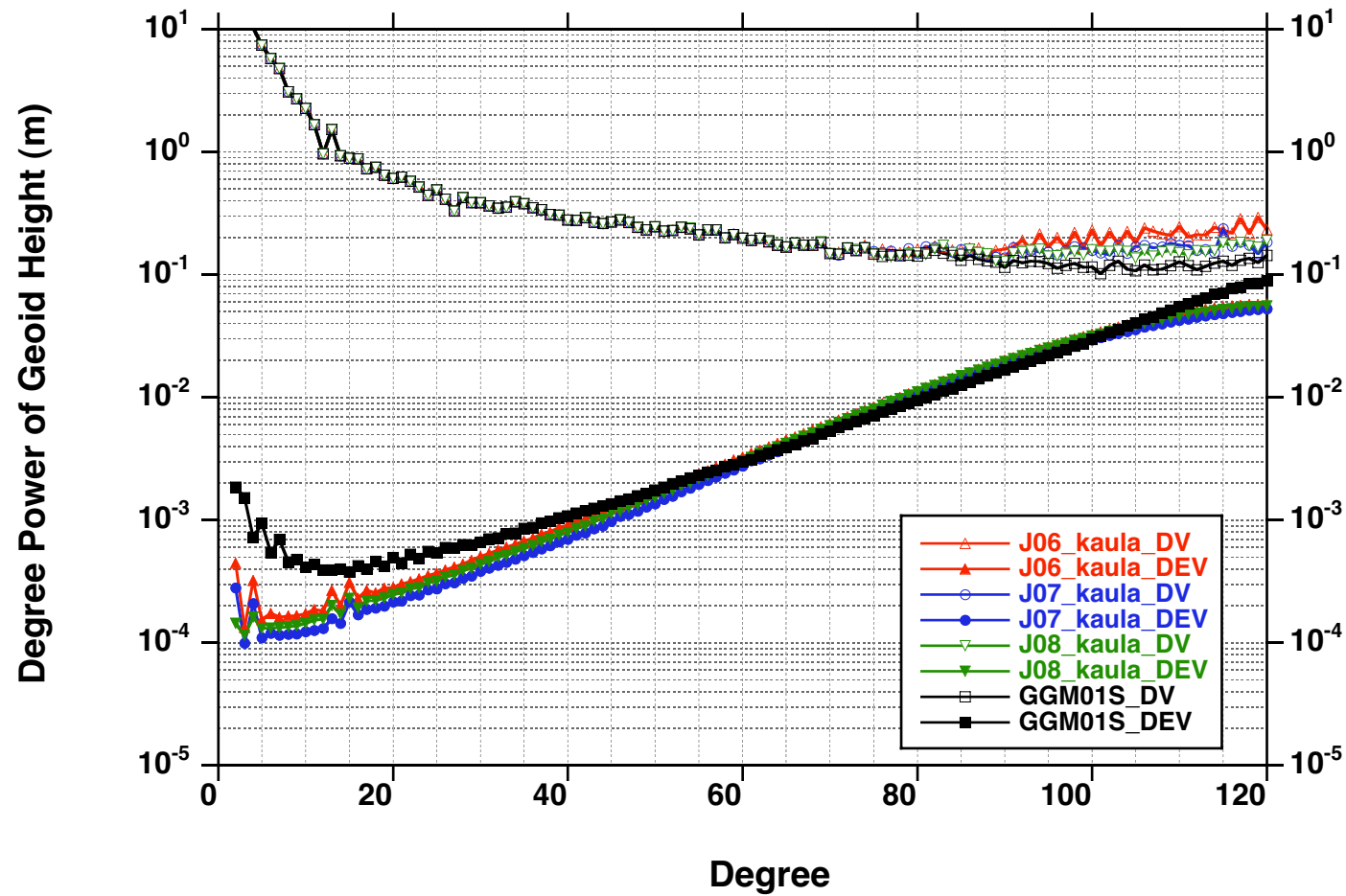

Statistical Comparison of GRACE Gravity Solutions

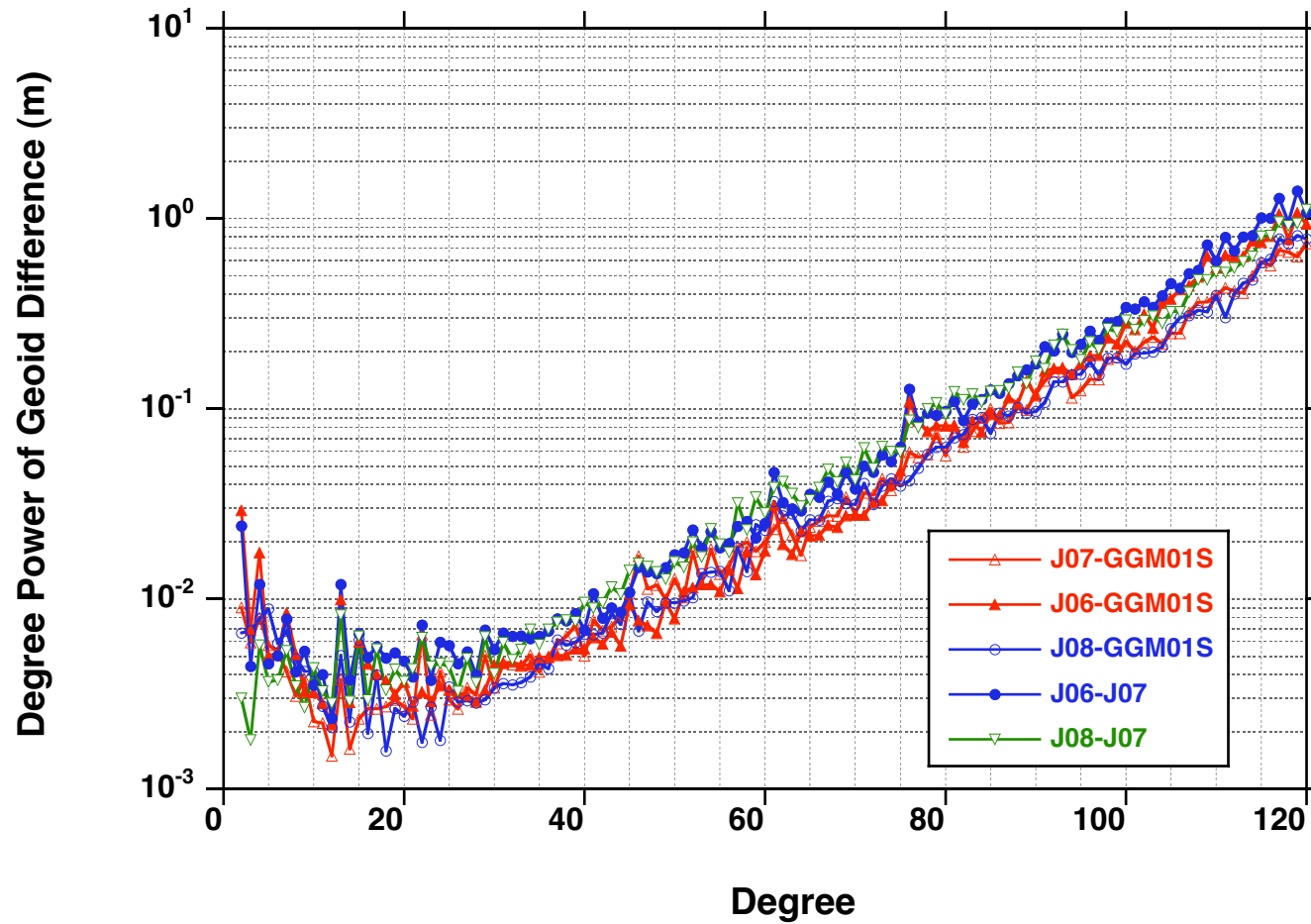

Statistical Comparison of GRACE Gravity Solutions

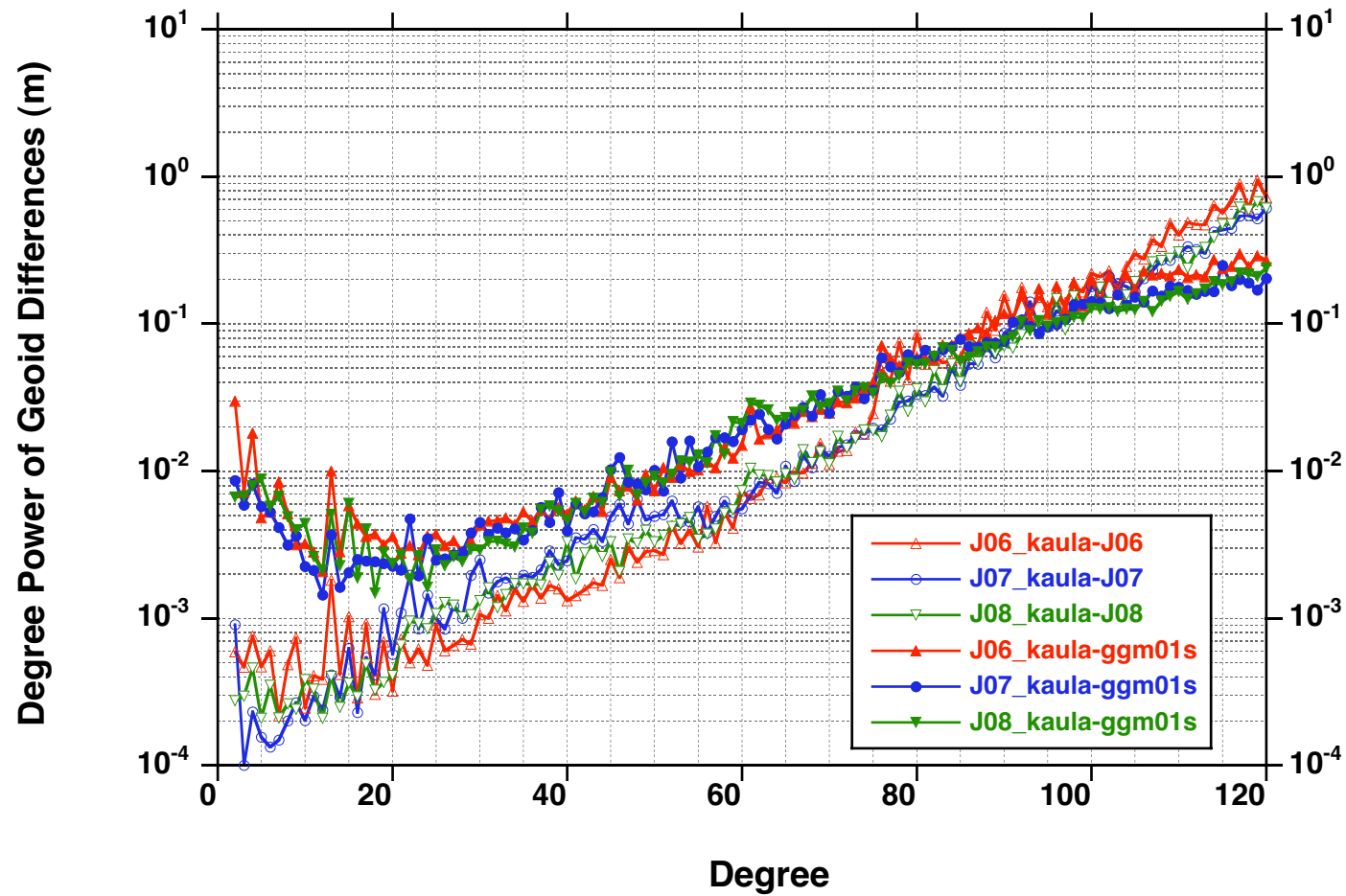

J04 and J03 Harmonics Differences
(GPS300CLK_TST_252)

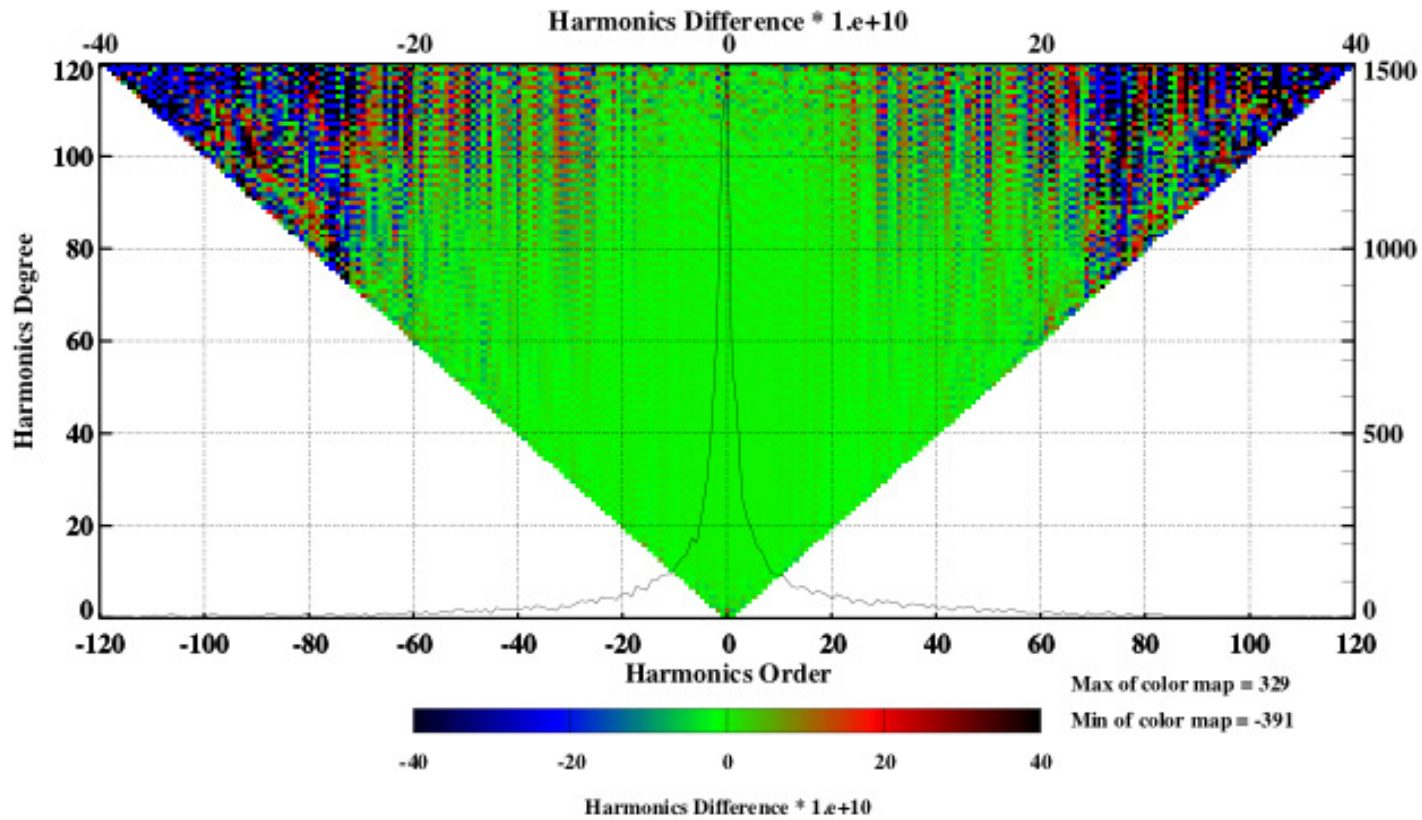

**J04 and J03 Harmonics Differences
(GPS300CLK_TST_253)**

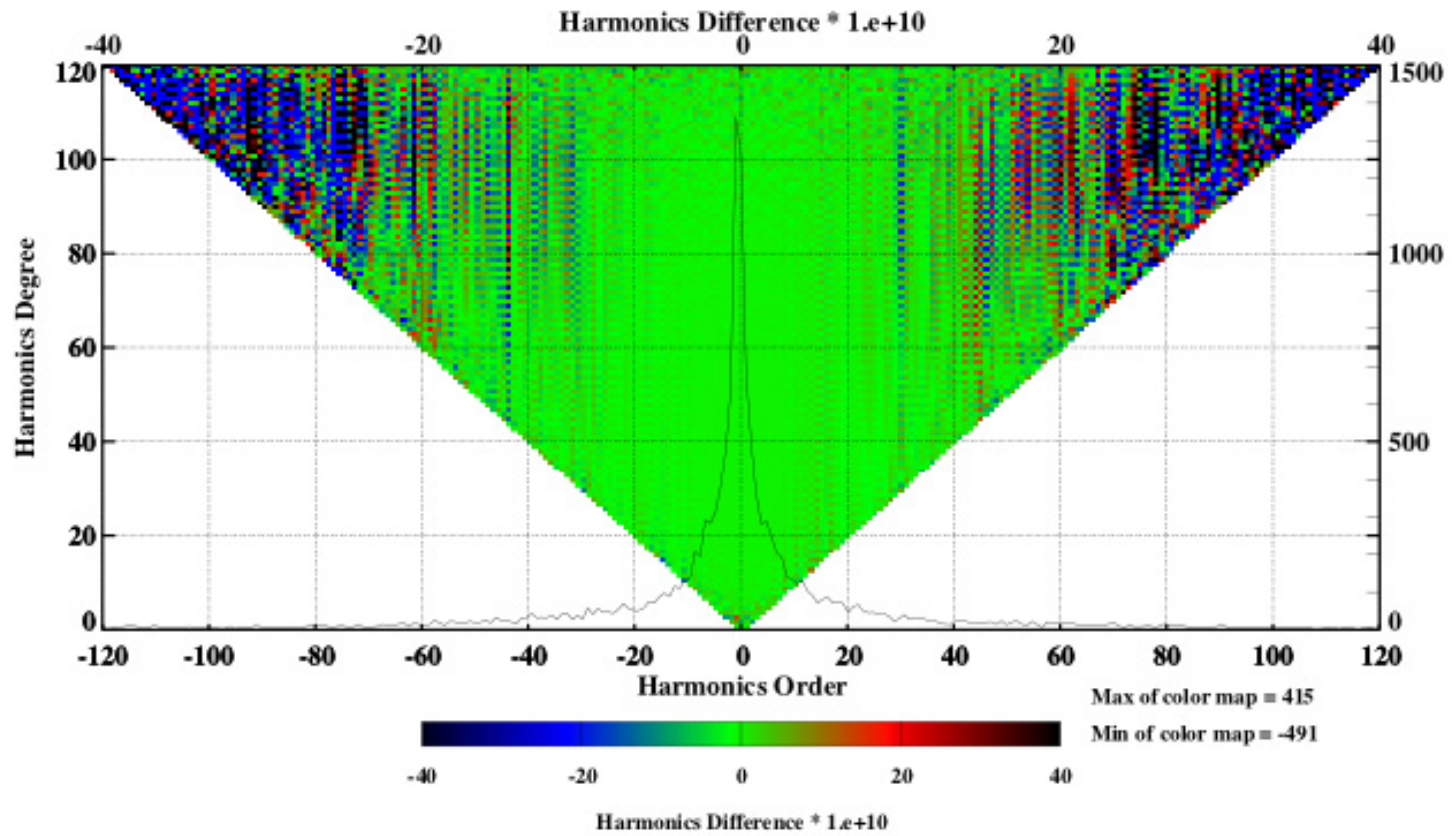

**Formal Error of J04 Harmonics
(GPS300CLK_TST_252)**

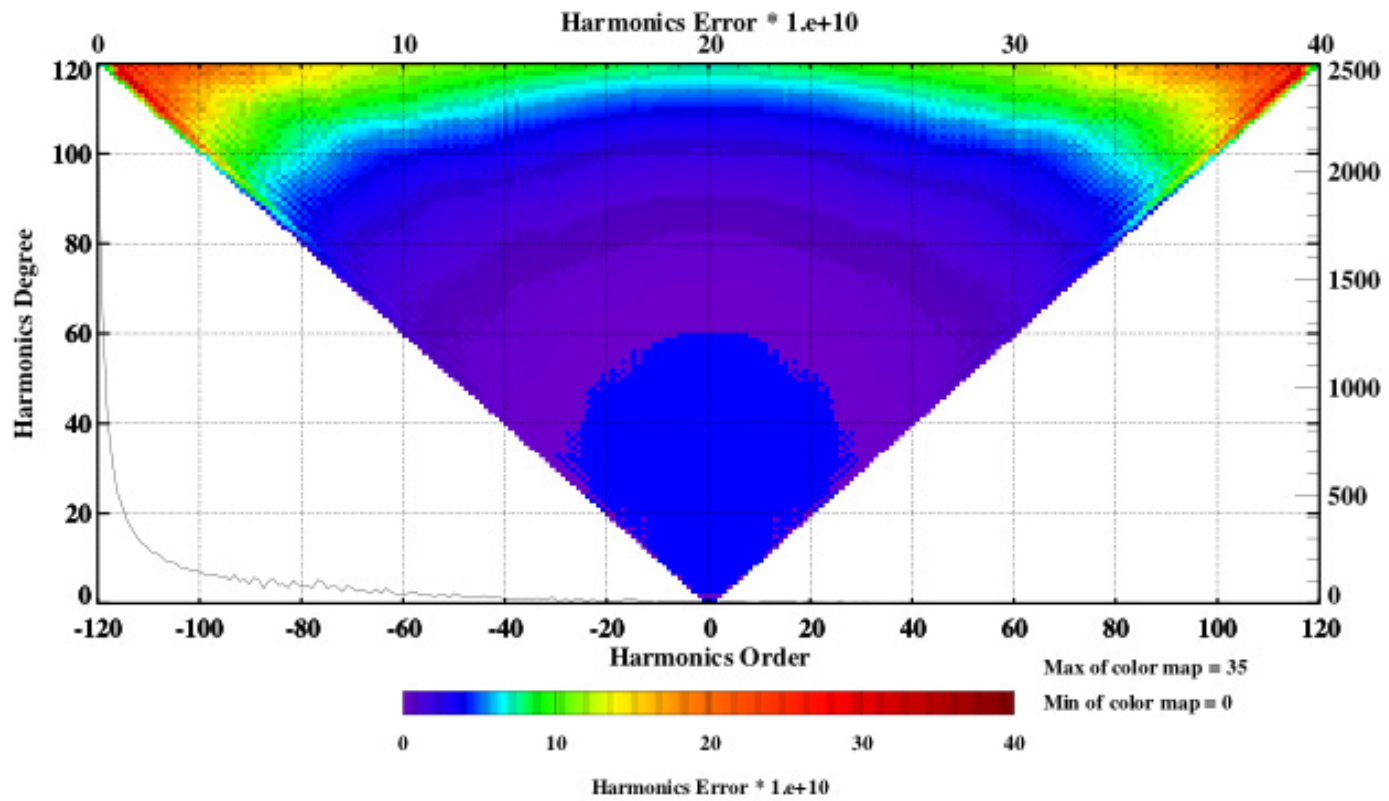

**Formal Error of J04 Harmonics
(GPS300CLK_TST_253)**

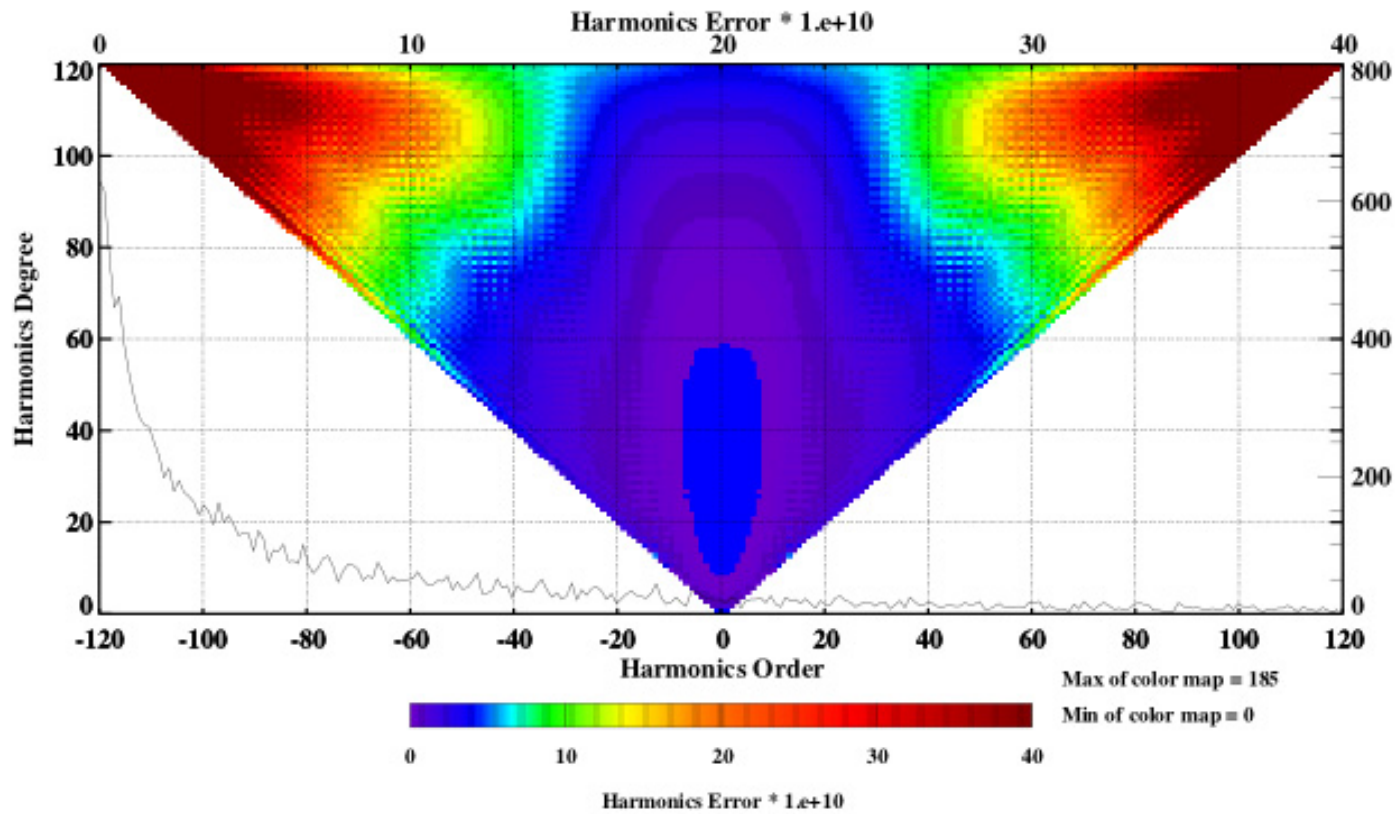

SLR and GPS residuals

- **Check SLR resids to GRACE s/c**
 - Should be at cm level
 - Will verify “absolute” positioning of GRACE s/c relative to Earth fixed frame using GPS (rqmt ~ few cm)

But

 - simulation indicates that the relative orbit error between GRACE s/c (R and T components) will be ~100 microns, so not much help for gravity purposes.
- **Check GRACE KBR resids against GPS derived relative position of s/c**
 - Good to cm level
 - Implemented at L-1 for quality control

Time Series/Trend Analysis on Sat-sat residuals

- Nominal GRACE design uses active control of temperatures to control geometric and RF sensitivity to thermal variations around orbit.
- However, some temperatures are captured in HK telemetry and some thermal characterization was performed in prelaunch ground testing
- Temperature dependent corrections to KBR or ACC data not yet implemented (nor studied in much detail) yet by SDS but still option for future

Time Series/Trend Analysis on Sat-sat residuals

- Example: KBR prelaunch thermal characterization

Component	Ka ($\mu\text{m}/\text{C}$)	K ($\mu\text{m}/\text{C}$)
MWA	1	1.5
Wave guide	10	11
24 GHz junction	0	22
USO	0.5	3
SPU	3.75	5
Horn (aperture end)	-10	-8
Horn (throat end)	4	4

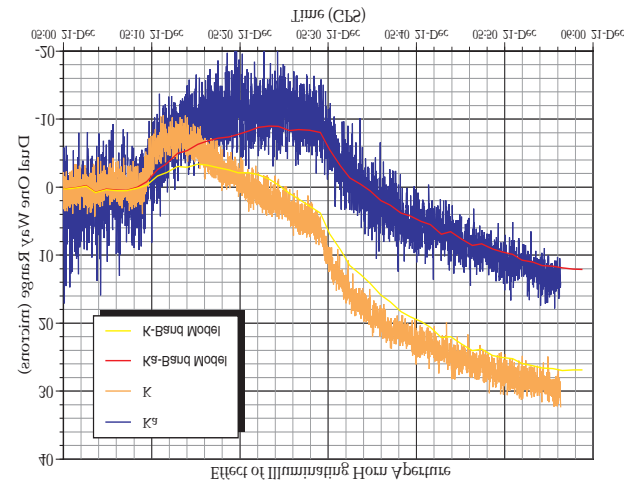

Conduct evaluations of de-aliasing models

- KBR residuals will also have signal from real gravity variability not removed in the monthly mean
 - **Attempt to dealias with ECMWF + barotropic ocean models**
 - **Some options in treatment of dealiasing**
 - Use geopotential heights vs. surface pressure
 - Methods of interpolating 6 hourly ECMWF data
 - Combination of ocean/atmosphere at land/sea boundary
 - Bottom friction parameter in ocean model
 - Others
 - **Evaluate to see which ones remove most power from KBR residuals**
 - **So far, SDS can see that the nominal dealiasing product is superior to no product, but alternate dealiasing products have neither been produced nor reviewed.**

Geopotential Height Cal/Val

- **Evaluate atmospheric pressure corrections with occultation data**
 - very sensitive to geopotential height, well distributed with respect to southern ocean, polar regions.
 - Also occultation data from CHAMP and SAC-C already being analyzed

Comparison of GPS/MET Retrieved Geopotential Heights to the ECMWF Summer AS-off Period

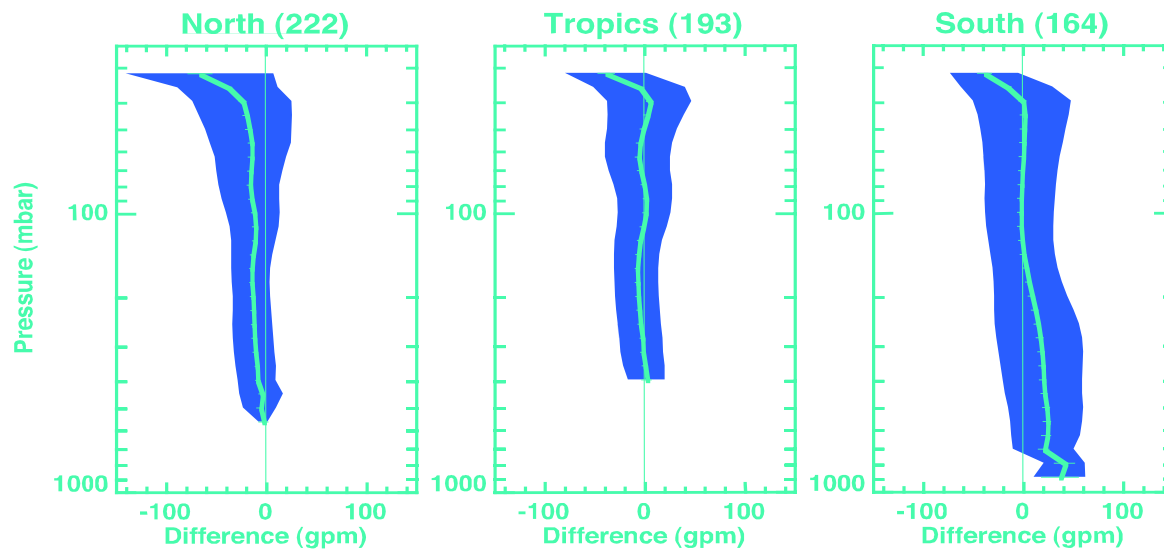

External Cal/Val Goal

- **Null test of gravity variability in “quiet” regions (Egypt and Saudi Arabia)**
 - Velicogna and Wahr have conducted exhaustive study of expected accuracy of results, available assets in Egypt, additional resources needed, and. MOU extant with Egyptian contact, some external funding from State Dept obtained

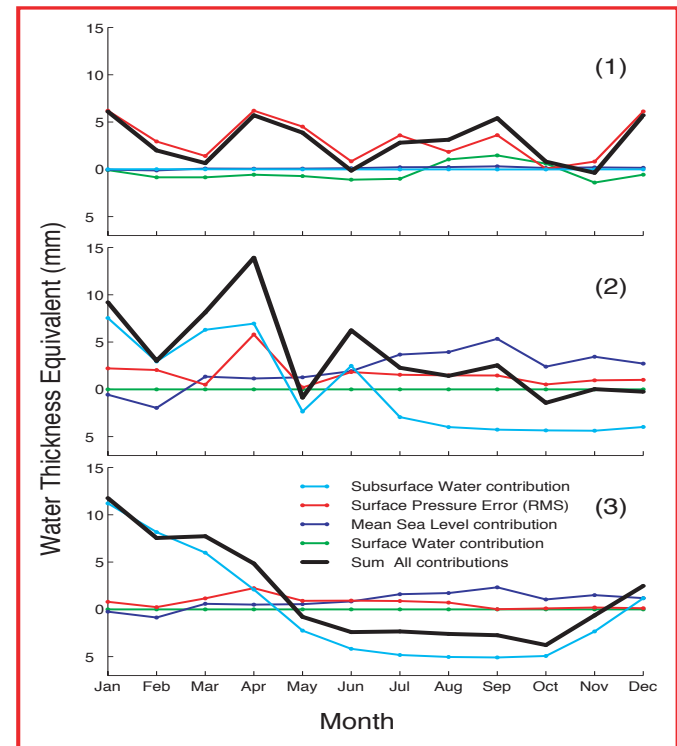
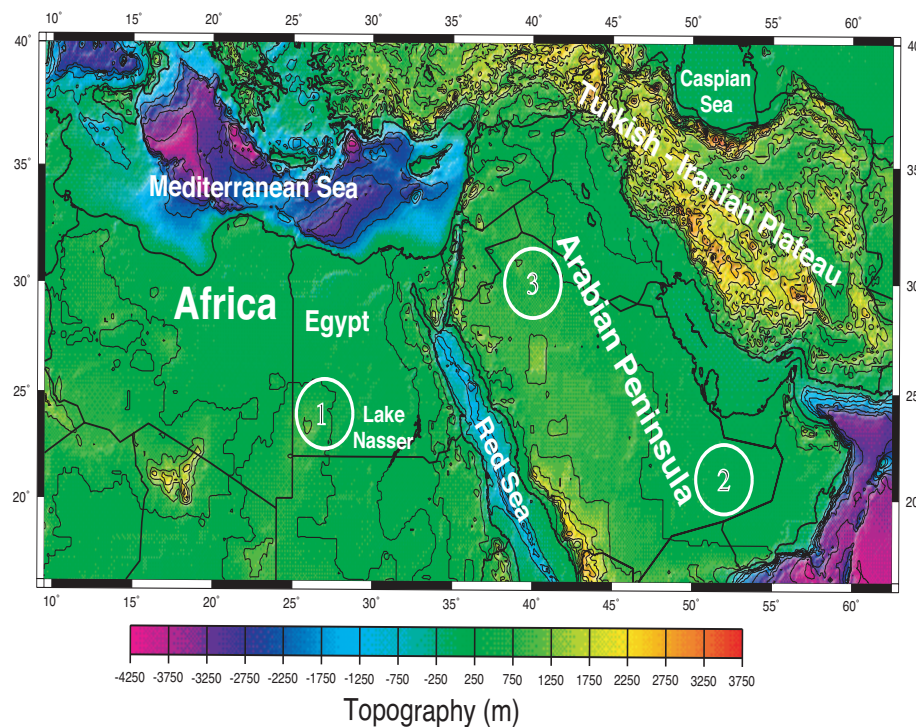

External Cal/Val Results

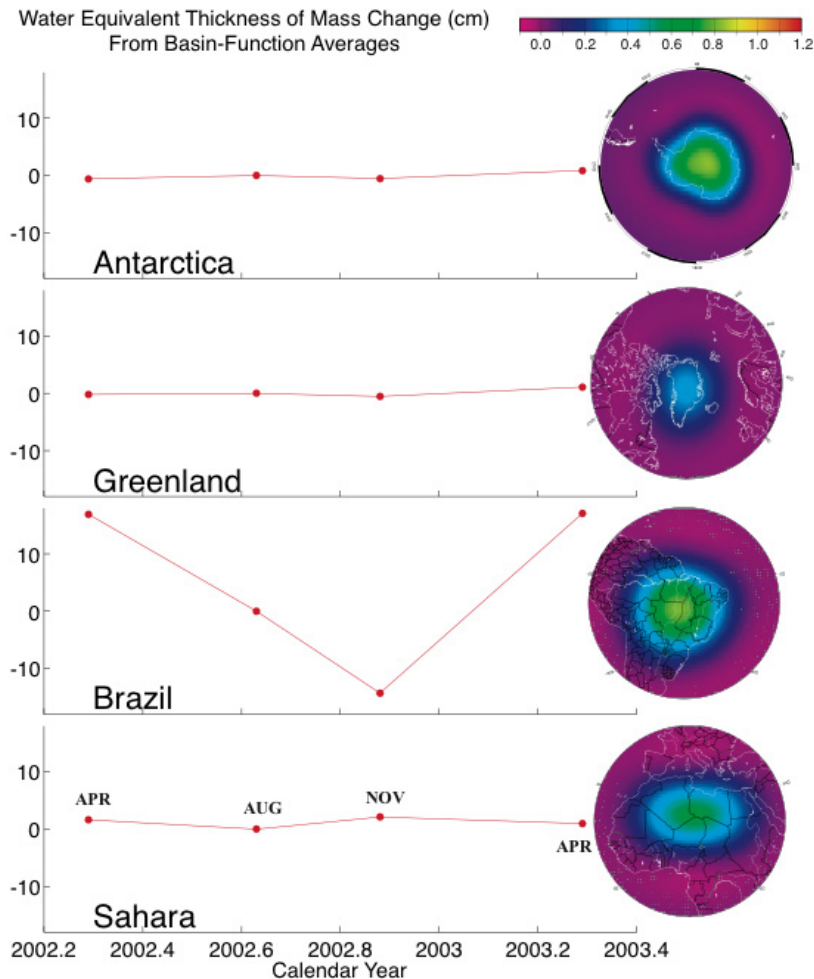

- Four monthly gravity solutions 2002-2003, averaged with “optimal” basin function by Velicogna et al
- Expected change in Amazon large, And it is.
- Expected change in others small (Sahara should be smallest, but Spatial resolution of fields insufficient To limit to most arid area

Bottom Pressure Recording

- 3 BPR's going in near Bermuda deployed by Kiel group
- Other NASA BPR activities under review

Ocean Bottom Pressure Cal (Dedicated Experiment)

Requirements:

Spatial mean good to $(0.1\text{mb})^2$

Temporal mean good to $(0.1\text{mb})^2$

Average out BPR noise

Recover data every month, leave in place for 5 years

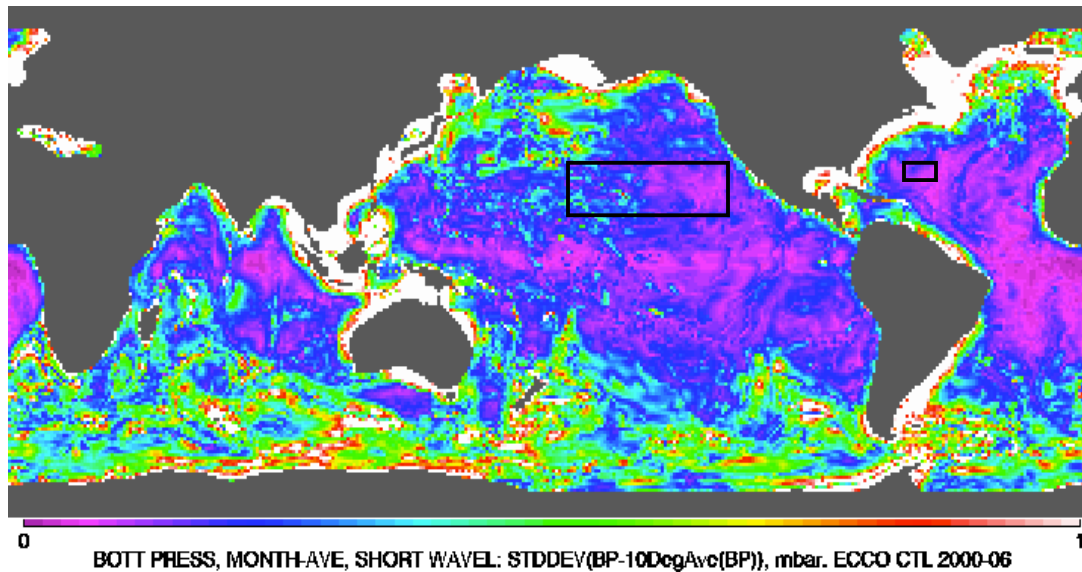

Spatial variability $L < 1000\text{KM}$

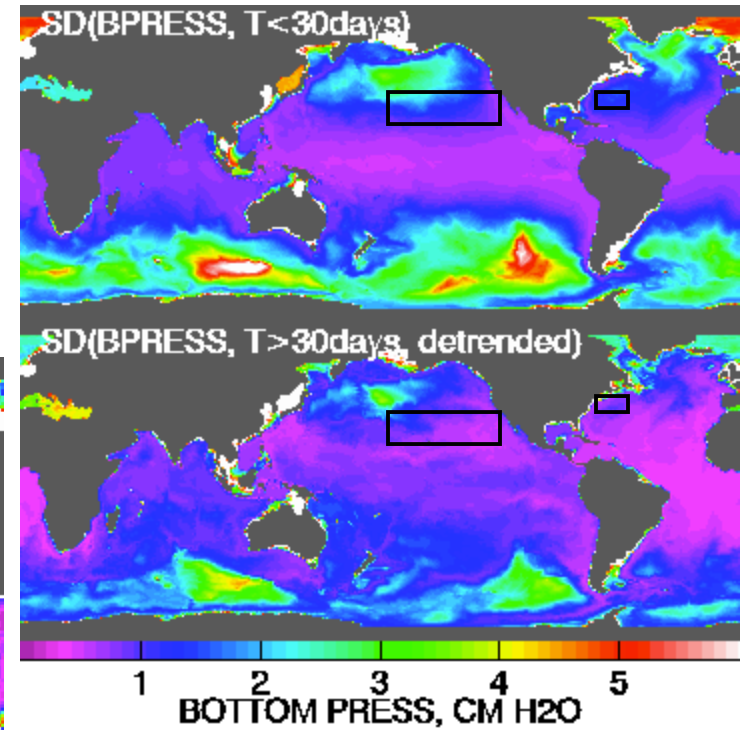

TIME VARIAB T < 60 Day

Possible locations:

- SE of Bermuda.
- Route San Diego-Hawaii.
- COSTS \$\$

Ocean Bottom Pressure Calibration (Opportunistic)

Time-average:

Combine gravity field and its errors, ocean temp, salinity, current meter, drifters and their errors, 'inverse solution' for time-averaged circulation.

Plus: free equipment (data already collected)

Minus: need more accurate estimate of barotropic current, acc

Time-varying:

Use existing BPR deployments

Plus: free equipment

Minus:

- stay in water for 1 to 3 years, not 5
- will not send data until 6-12 months after launch
- very few in existence

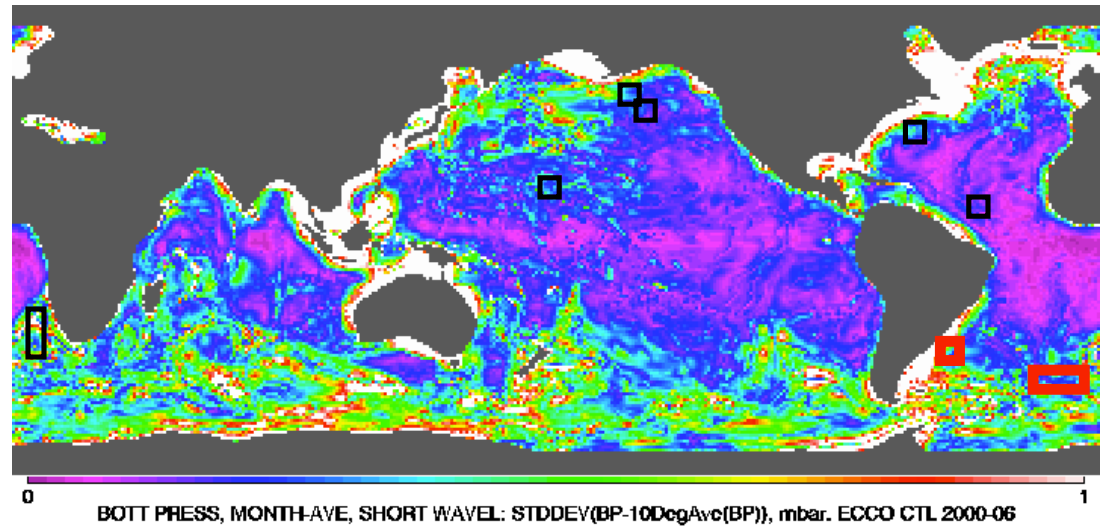

- Unrelated to grace
- Coordinated with grace (uk/pol; germany/awi)

Direct External Gravity Cal/Val

- **Gravimeter Comparison**
 - Offers from numerous gravimeter groups around the world
 - Main problem is removing highly localized effects such as soil moisture and deep water storage.

Summary

- Battery of “internal” tests are probably the main cal/val
- Some external tests - difficult for both static and time varying field calibration
- **We welcome input from science community!**





Short-term Atmosphere and Ocean Gravity De-aliasing for GRACE

Frank Flechtner

GeoForschungsZentrum Potsdam (GFZ)
Department 1 "Geodesy & Remote Sensing"

GRACE Science Team Meeting
Austin, TX, October 8-10, 2003



- Background
- Barotropic ocean model
- Atmosphere modeling
- Combination of ocean and atmosphere and resulting products
- Product validation
- Application in orbit and gravity field determination
- Conclusions

- GRACE shall produce mean monthly gravity solutions with unprecedented accuracy (e.g. cumulative monthly geoid height error shall be less than 0.4 mm ($n < 70$))
- Therefore all short term (hourly to weekly) mass variations caused by atmosphere, oceans and hydrology have to be taken into account.
- Mass variations cause time variant forces acting on the satellites which can be avoided by
 - a) repeated observations within short time intervals
(would decrease the spatial resolution of GRACE!)
 - b) appropriate correction models applied during product generation

- GRACE sensitivity to these signals is up to approximately degree 35-40 (1150 - 1000 km wavelength)

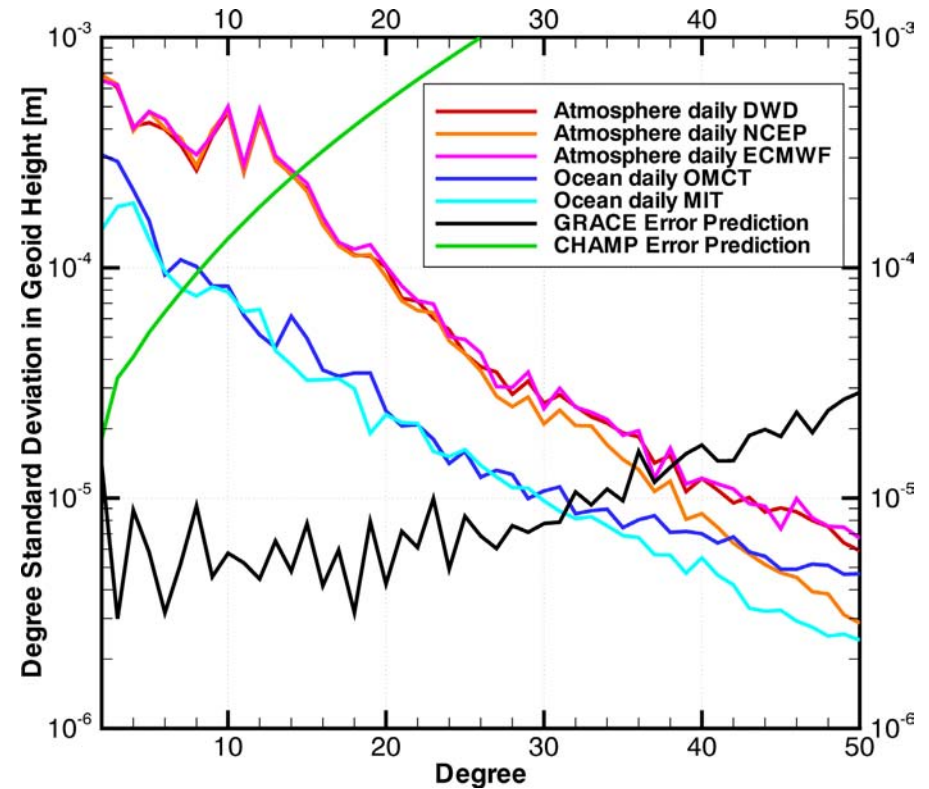

- Models for correction:
 - atmosphere/ocean models driven by atmospheric fields
 - global hydrology models with sufficient resolution and accuracy presently not existing
- 6 hourly 0.5° ECMWF grid data regularly acquired by GFZ

- Barotropic model (constant vertical density) PPHA (Pakanowski, Ponte, Hirose, Ali) provided by JPL is running operationally at GFZ since March 2002 (update in July 2002)
- Input:
 - 6 hourly 0.5° ECMWF grid data (surface pressure, dew point temperature @ 2 m, sea surface temperature, 10 m u/v wind speed, temperature @ 2 m)
 - initial ocean state (June 30, 2000 = homogeneous CHAMP/GRACE processing possible)
- Output: hourly 1.125° grids of barotropic sea level [cm], for latitudes between -75.375° and 65.250° including Mediterranean, smaller enclosed seas and bays

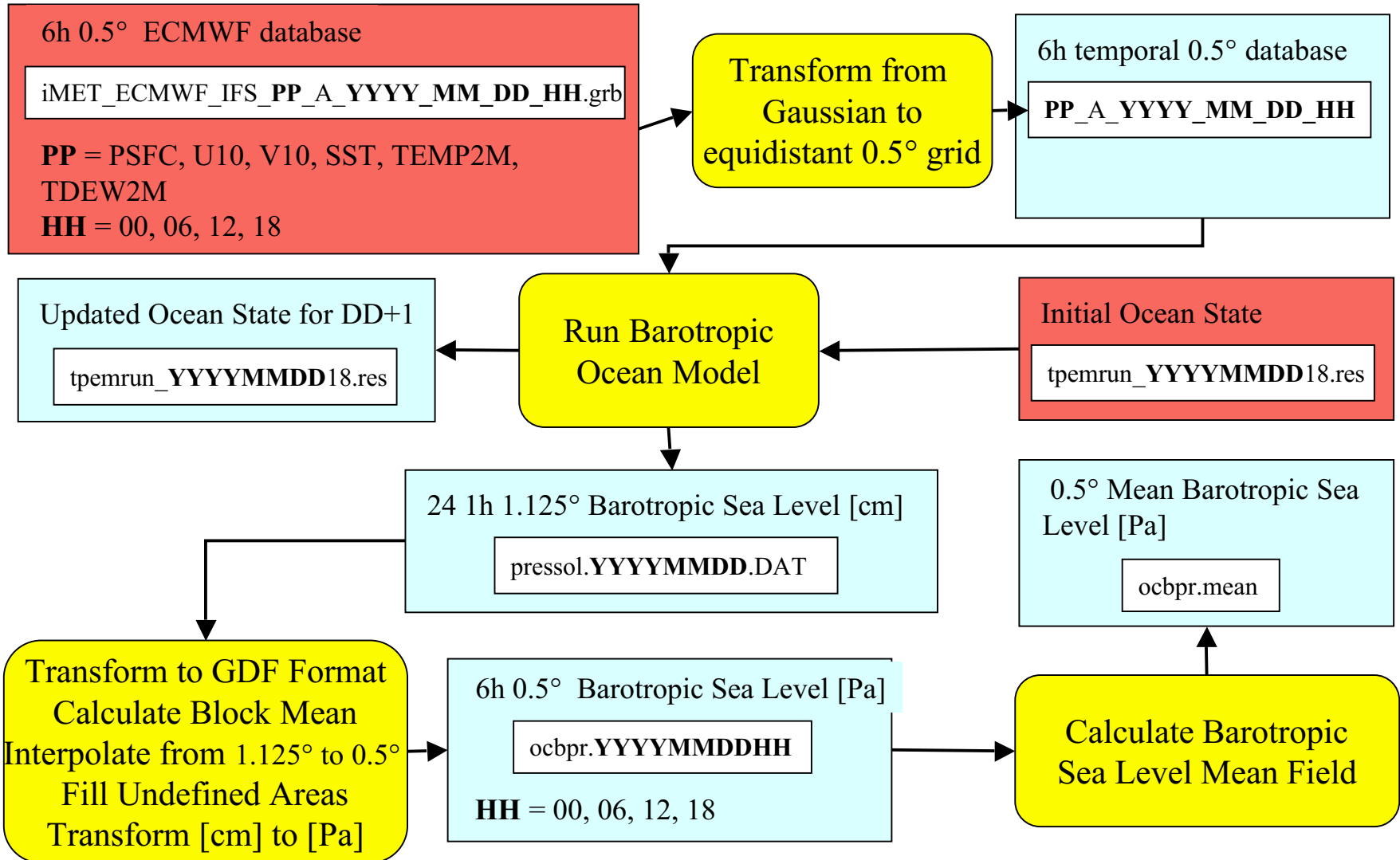

ECMWF Data 18.10.2001 00:00
Ocean Model Output [Pa]

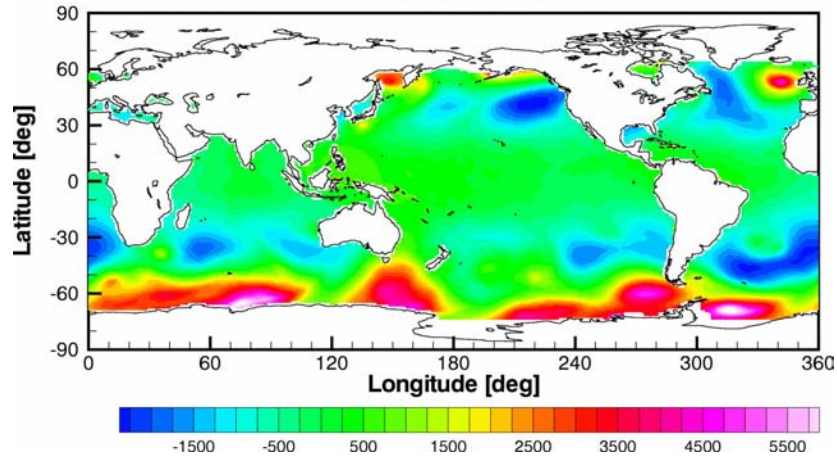

ECMWF Data 18.10.2001 00:00
Mean Ocean Model Output 2001 [Pa]

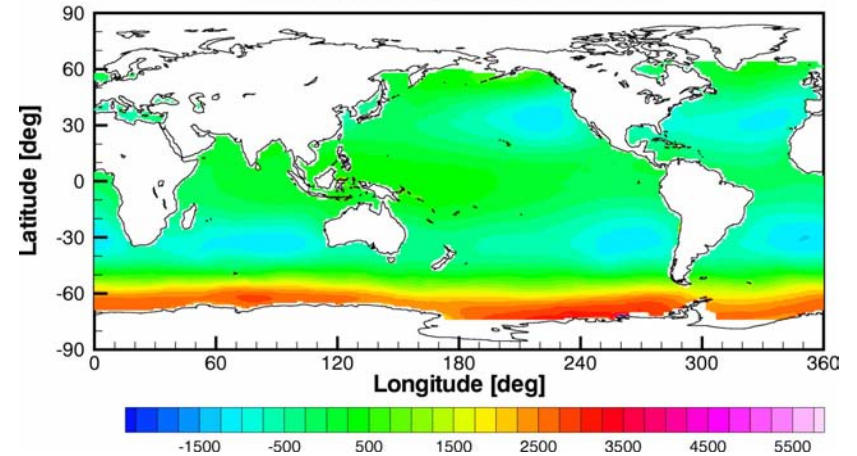

ECMWF Data 18.10.2001 00:00
Ocean Model Output - Mean 2001 [Pa]

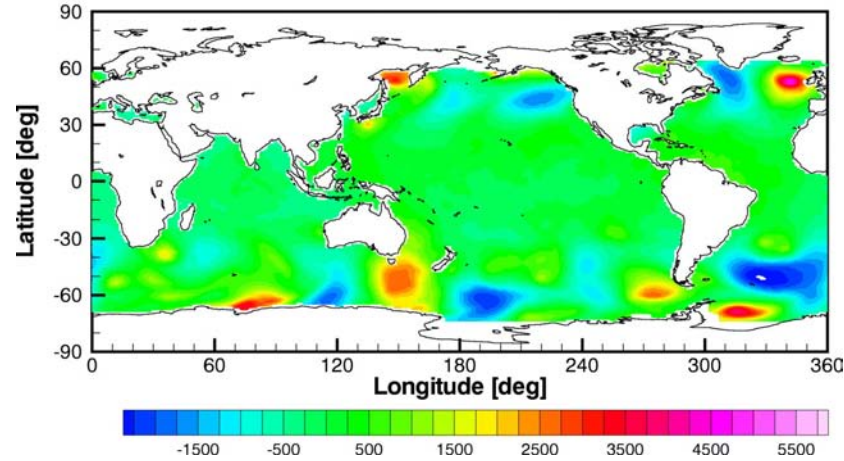

Two different approaches in de-aliasing software implemented:

1.) Surface pressure (SP)

$$\Delta C_{nm} = \frac{a^2(1+k_n)}{(2n+1)Mg_{\text{Earth}}} \iint (P_s - \bar{P}_s) P_{nm}(\cos\theta) \cos(m\lambda) dS$$

$$\Delta S_{nm} = \frac{a^2(1+k_n)}{(2n+1)Mg_{\text{Earth}}} \iint (P_s - \bar{P}_s) P_{nm}(\cos\theta) \sin(m\lambda) dS$$

K_n : Load Love numbers (Dong *et al.* (1996), Farrel (1972))

2.) Vertical Integration (VI) over atmospheric column

$$\Delta C_{nm} = -\frac{a^2(1+k_n)}{(2n+1)Mg_{\text{Earth}}} \iint_{\text{Earth}} \left(\int_{P_s}^0 \left(\frac{a}{a-\Phi} + \frac{\xi r}{a} \right)^{n+4} dP \right) - \bar{P}_{VI} P_{nm}(\cos\theta) \cos(m\lambda) \sin\theta d\theta d\lambda$$

$$\Delta S_{nm} = -\frac{a^2(1+k_n)}{(2n+1)Mg_{\text{Earth}}} \iint_{\text{Earth}} \left(\int_{P_s}^0 \left(\frac{a}{a-\Phi} + \frac{\xi r}{a} \right)^{n+4} dP \right) - \bar{P}_{VI} P_{nm}(\cos\theta) \sin(m\lambda) \sin\theta d\theta d\lambda$$

with $\Phi_{k+1/2} = \Phi_s + \frac{1}{g} \sum_{j=k+1}^{N_{\text{level}}} R_{\text{dry}} T_v \ln \frac{P_{j+1/2}}{P_{j-1/2}}$

= geopotential height at half level

T_v = virtual Temperature = $f(T_{\text{level}}, \text{SHum}_{\text{level}})$

$$P_{k+1/2} = a_{k+1/2} + b_{k+1/2} P_s$$

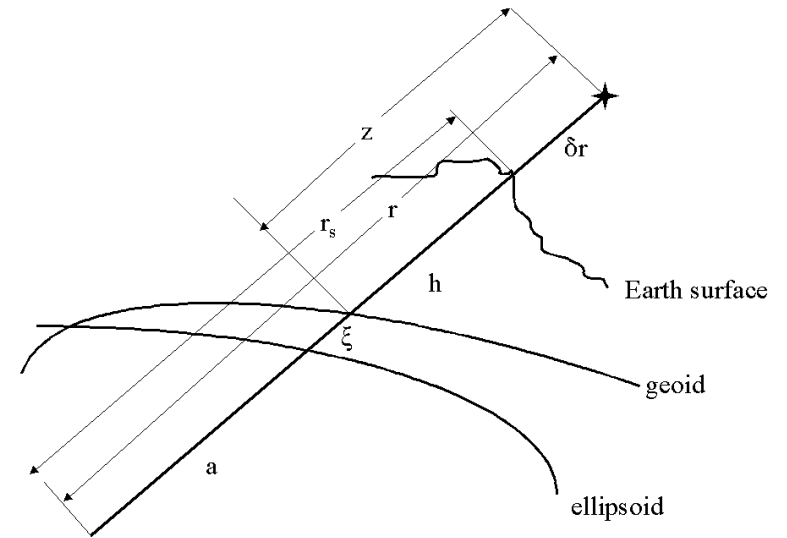

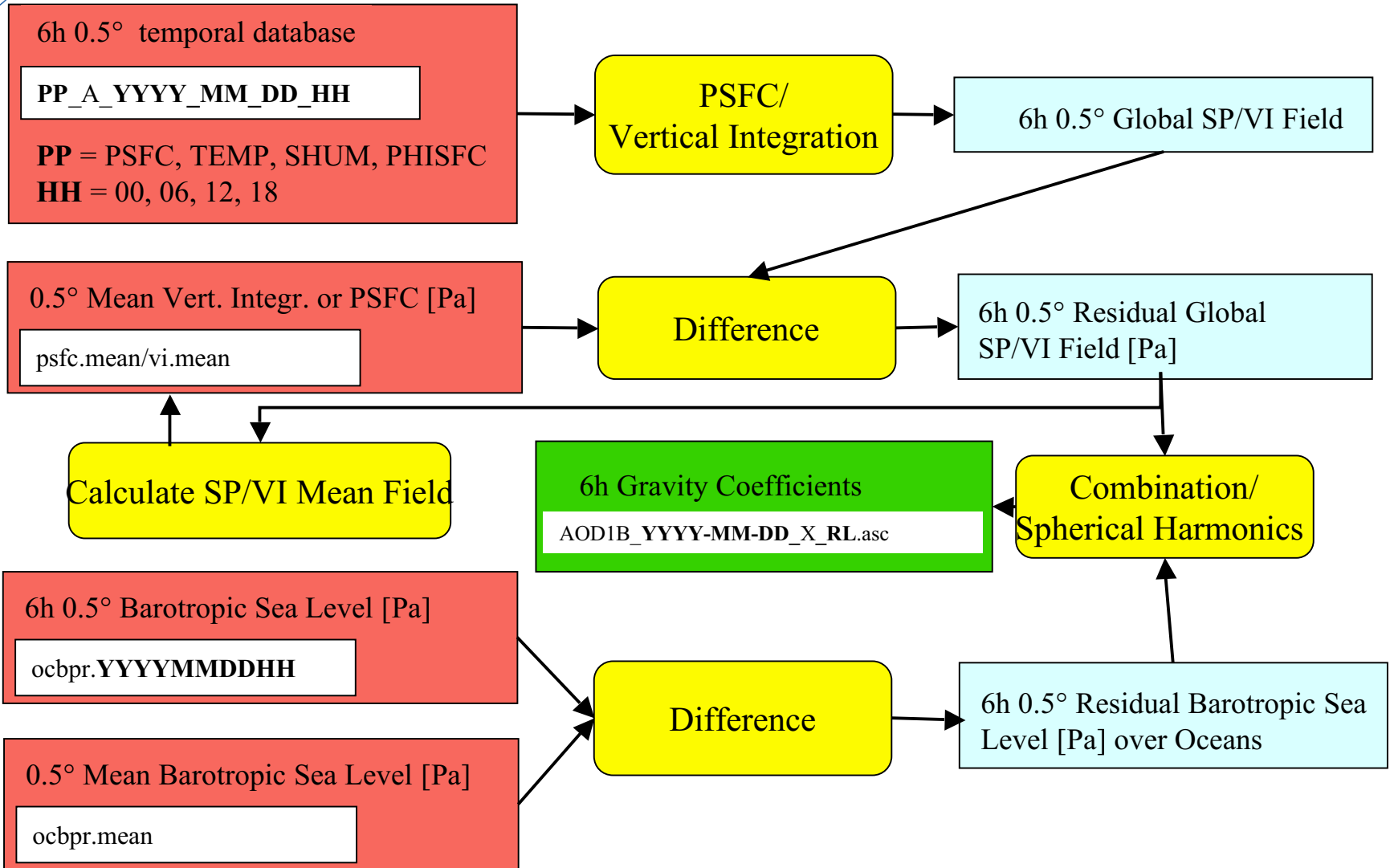

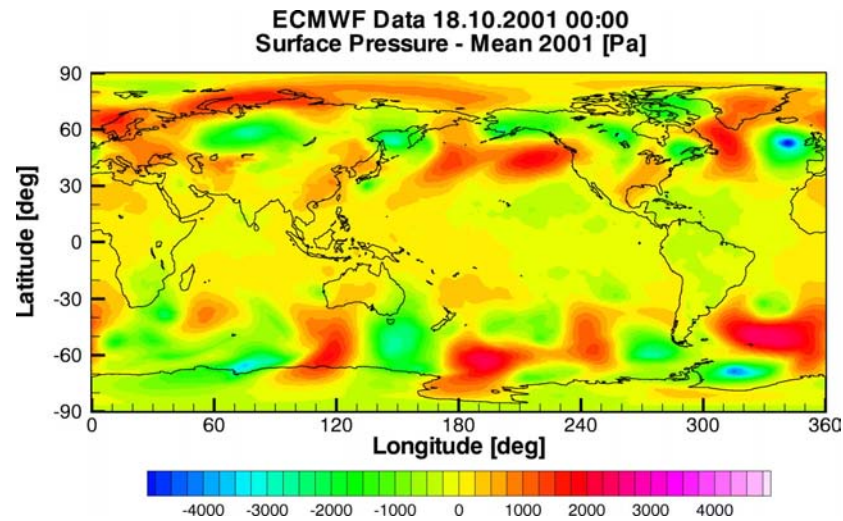
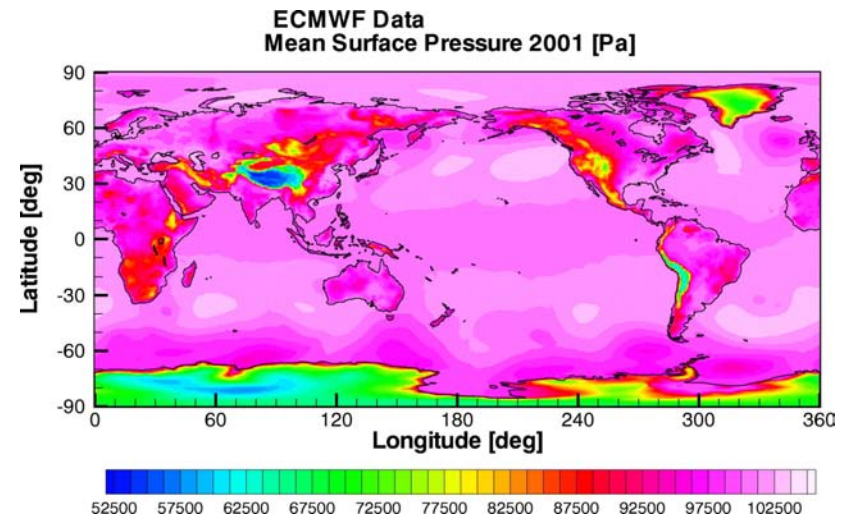
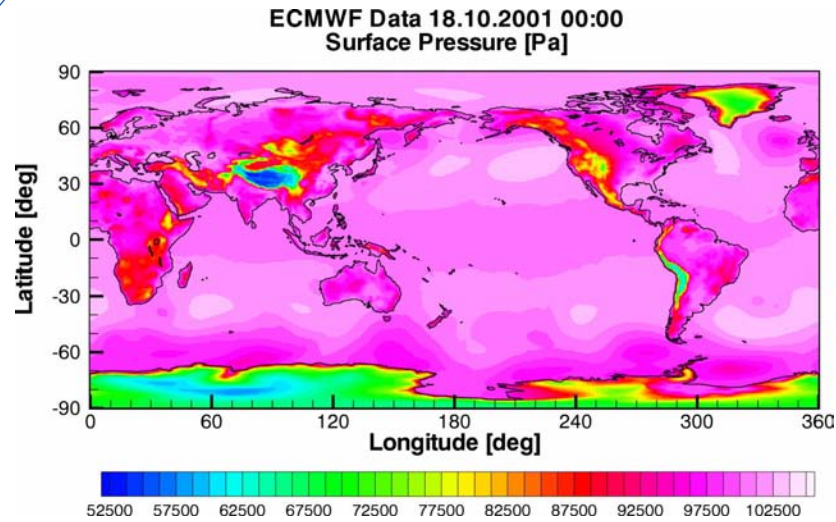

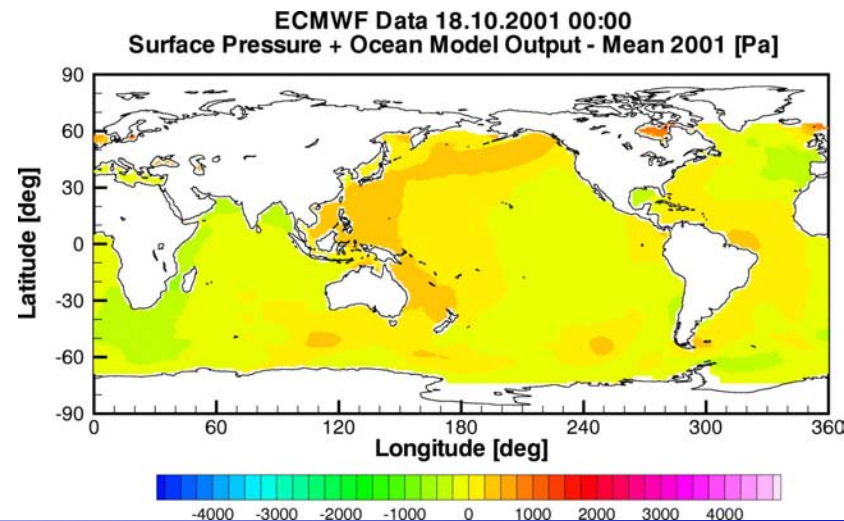
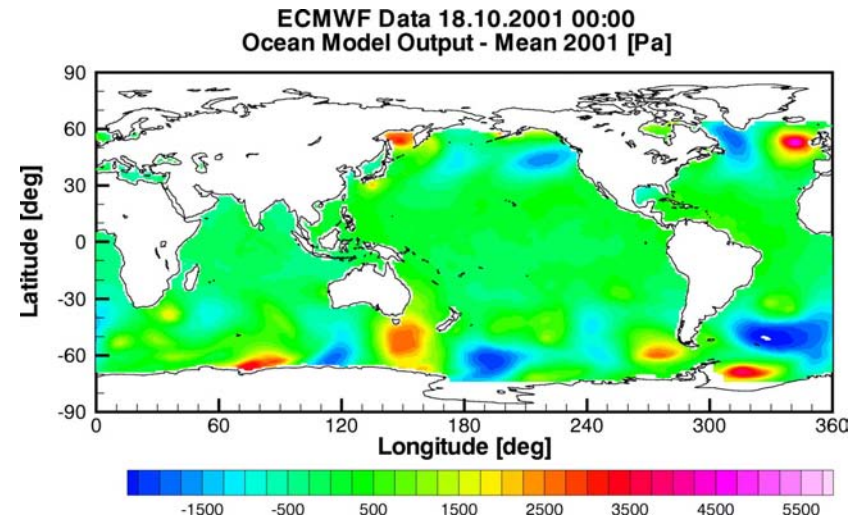
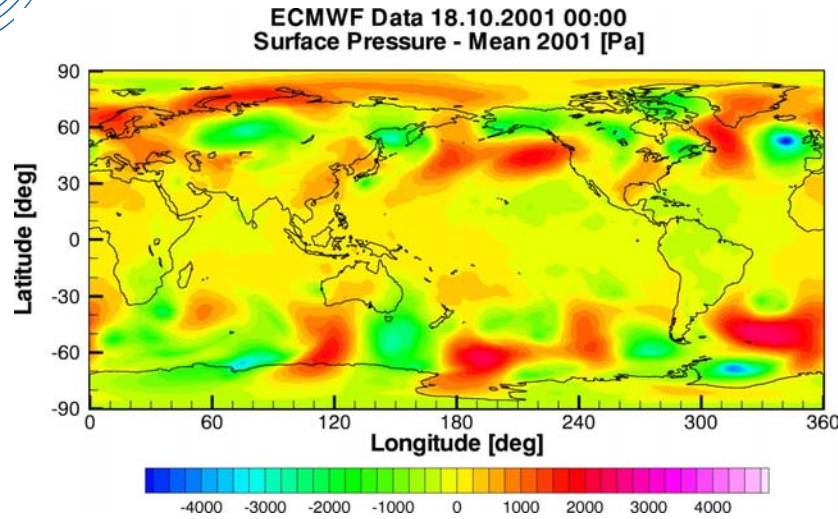

- Ocean model residuals are **added** to surface pressure resp. vertical integration residuals (for each grid point)
- Undefined areas set to 0
- Result about 0 Pa (compensation)

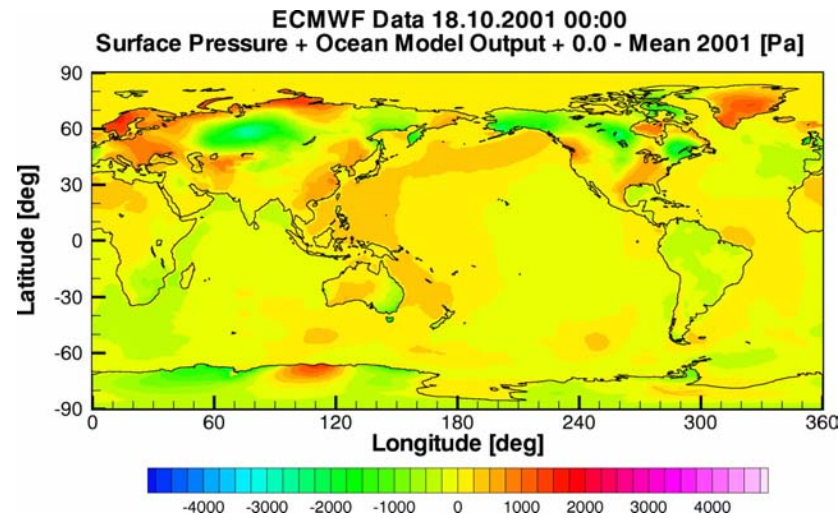
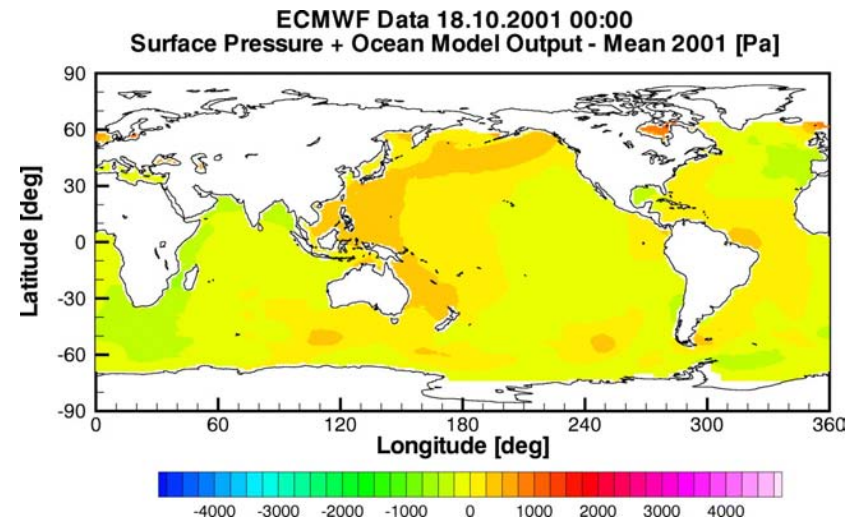
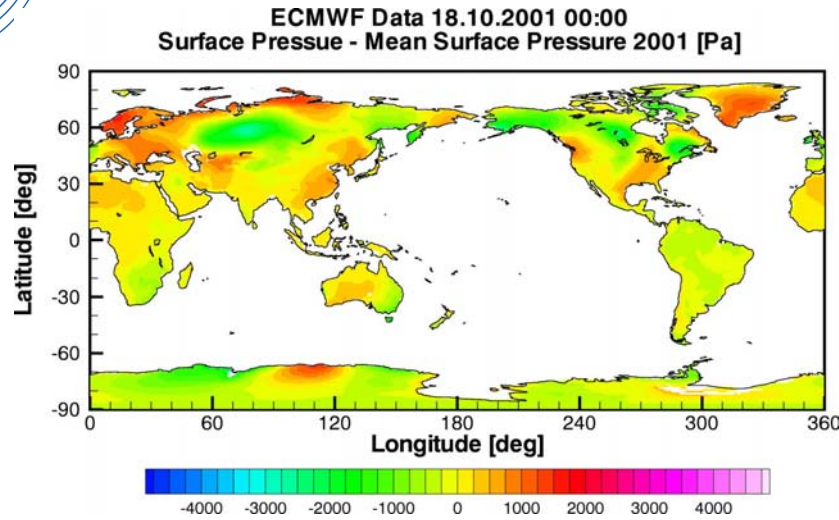

- **Land plus snow and ice:**
SP/VI result - mean SP/VI field
- **Ocean:** see previous slide
- **Undefined ocean areas:** 0.0 (IB)

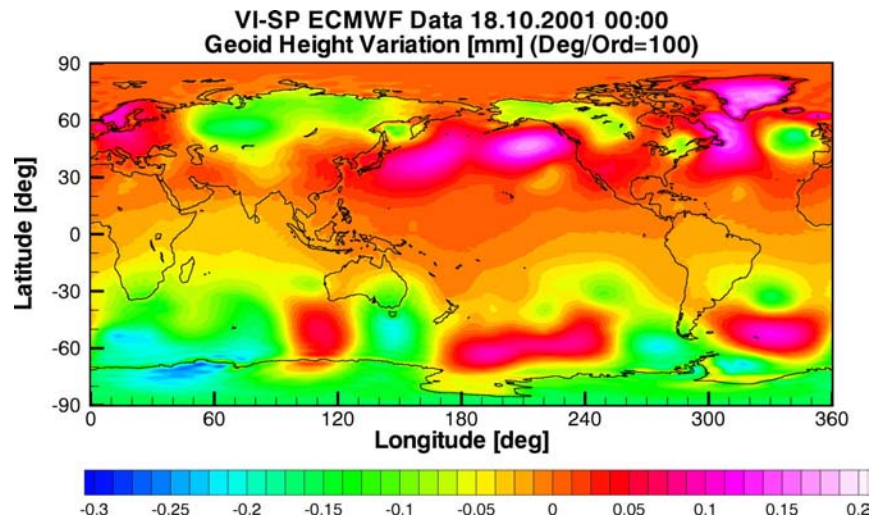
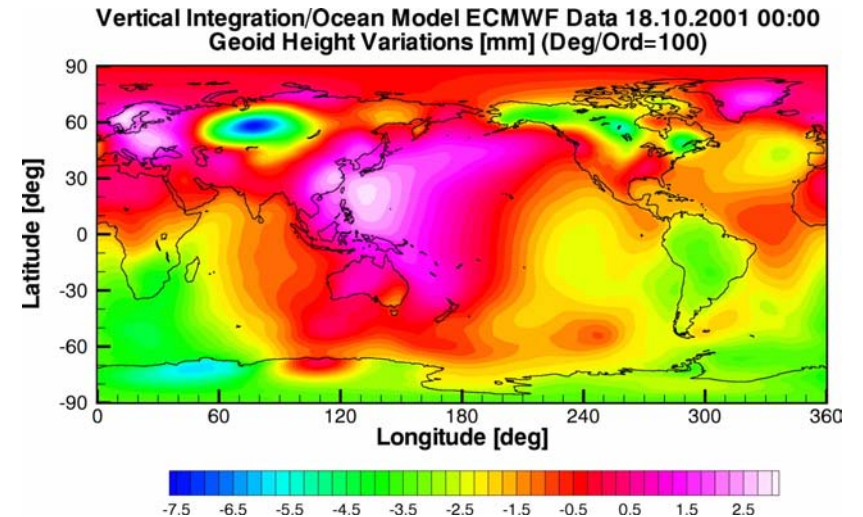
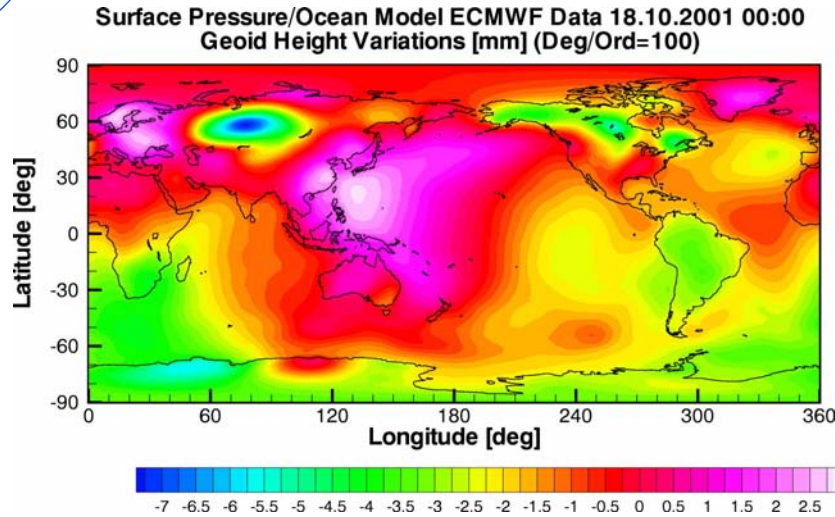

Example of geoid height variation for SP and VI approach and their difference (degree/order 100)



Available De-aliasing Products



Results from spherical harmonic analysis up to degree and order 100 are available for VI approach at GRACE ISDC (GFZ) as daily products for period July 2000 until September 14, 2003 as release 01:

AOD1B (Atmosphere and Ocean De-aliasing Level 1B) product
(Header plus ASCII spherical harmonic coefficients, zipped)

AOD1B_YYYY-MM-DD_X_01.asc.gz (900 KB)

containing 3 sets of coefficients (atmosphere only / ocean only / global combination) each 6 hours

OCN1B (Ocean Model Output Level 1B) product (L1 header plus PPHA ocean model hourly output binary data)

OCN1B_YYYY-MM-DD_X_00.DAT (3.8 MB)



Geoid height variations Jul. 01, 2000 - August 31, 2003
due to atmospheric (VI) and oceanic mass variation

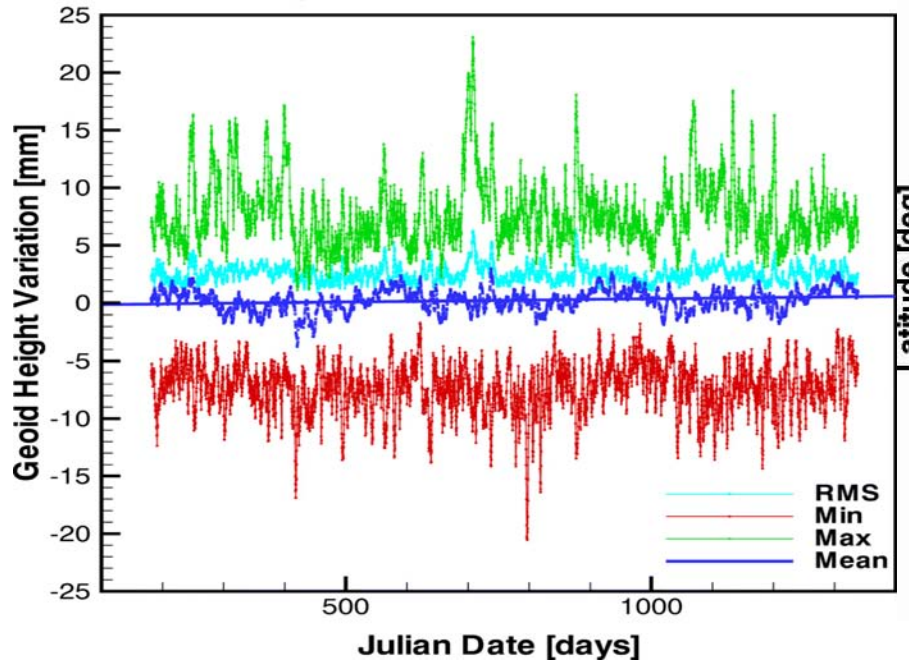

Geoid Height Variations [mm] 2002050100

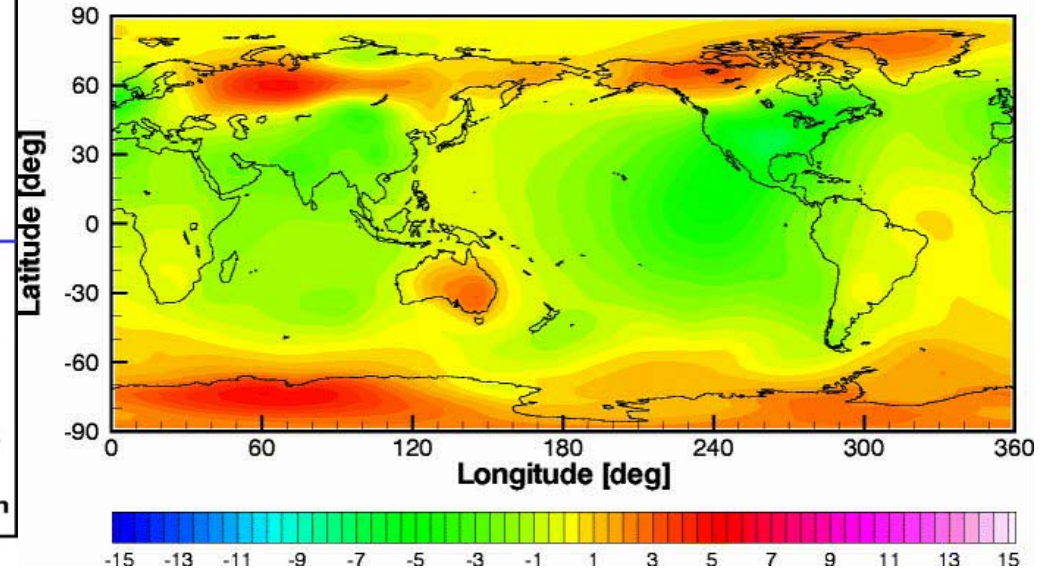

- Min, max, mean and RMS values are calculated for all 6-hourly VI geoid height variations
- MPEG video may show Gibbs phenomena etc.



AOD1B used in POD and NEQ GRACE Arcs



RMS values based on 4 May 02 GRACE NEQ arcs EIGEN-GRACE01S gravity field, KBR weighting 200 μm , 0.9 $\mu\text{m/s}$					
De-aliasing model	SLR [cm]	GPS Code [cm]	GPS Phase [cm]	K-band Range [μm]	K-band R-Rate [$\mu\text{m/s}$]
None	7.07 (409)	50.10 (240448)	1.26 (240448)	77.22 (97934)	0.72 (97913)
VI (GFZ 50)	5.92 (409)	49.30 (240400)	1.12 (240400)	70.28 (97934)	0.66 (97912)
VI (GFZ 100)	5.92 (409)	49.29 (240369)	1.12 (240369)	66.17 (97934)	0.66 (97912)
SP (GFZ 50)	5.93 (409)	49.31 (240381)	1.12 (240381)	62.74 (97934)	0.66 (97910)
SP (GFZ 100)	5.93 (409)	49.33 (240355)	1.12 (240355)	68.54 (97934)	0.66 (97912)
VI (GRGS 100)	6.46 (409)	49.55 (240324)	1.15 (240324)	71.33 (97934)	0.67 (97914)

- Use of AOD1B gives significant improvement for all RMS values
- No major difference visible between VI and SP resp. degree 50 and 100
- French product slightly worse (SLR, GPS)





AOD1B used in gravity field determination



- UTCSR has derived a gravity field with and without AOD1B based on November 2002 GRACE data
- Resulting gravity fields have then been used in POD for different geodetic satellites. Most of the SLR RMS improved.

=> confirms GFZ results



- SW for combination of barotropic sea level with SP or VI approach operational.
- Mean SP and VI field for 2001 calculated.
- De-aliasing products for degree and order 100 are available for VI approach at GRACE ISDC as daily products for July 2000 until today.
- For “quality control” min/max/mean/rms values are calculated, corresponding geoid height variations can be animated
- Geoid height differences between SP and VI are usually on a ± 0.3 mm level but can be up to 1 mm: VI has to be used to meet the GRACE requirements

- Different GFZ/GRGS de-aliasing products have been compared in GRACE POD and NEQ calculation
 - Use of de-aliasing models leads to significant improvement in RMS values
 - Up to now no difference between VI and SP resp. degree/order 100/50 visible
 - May be more significant if KBR weighting is increased and gravity field improved
- GFZ VI model has been used at CSR to derive gravity fields with and without de-aliasing. Results promising.
- “GRACE AOD1B Product Description Document” (Draft) available

Aliasing/de-aliasing overview

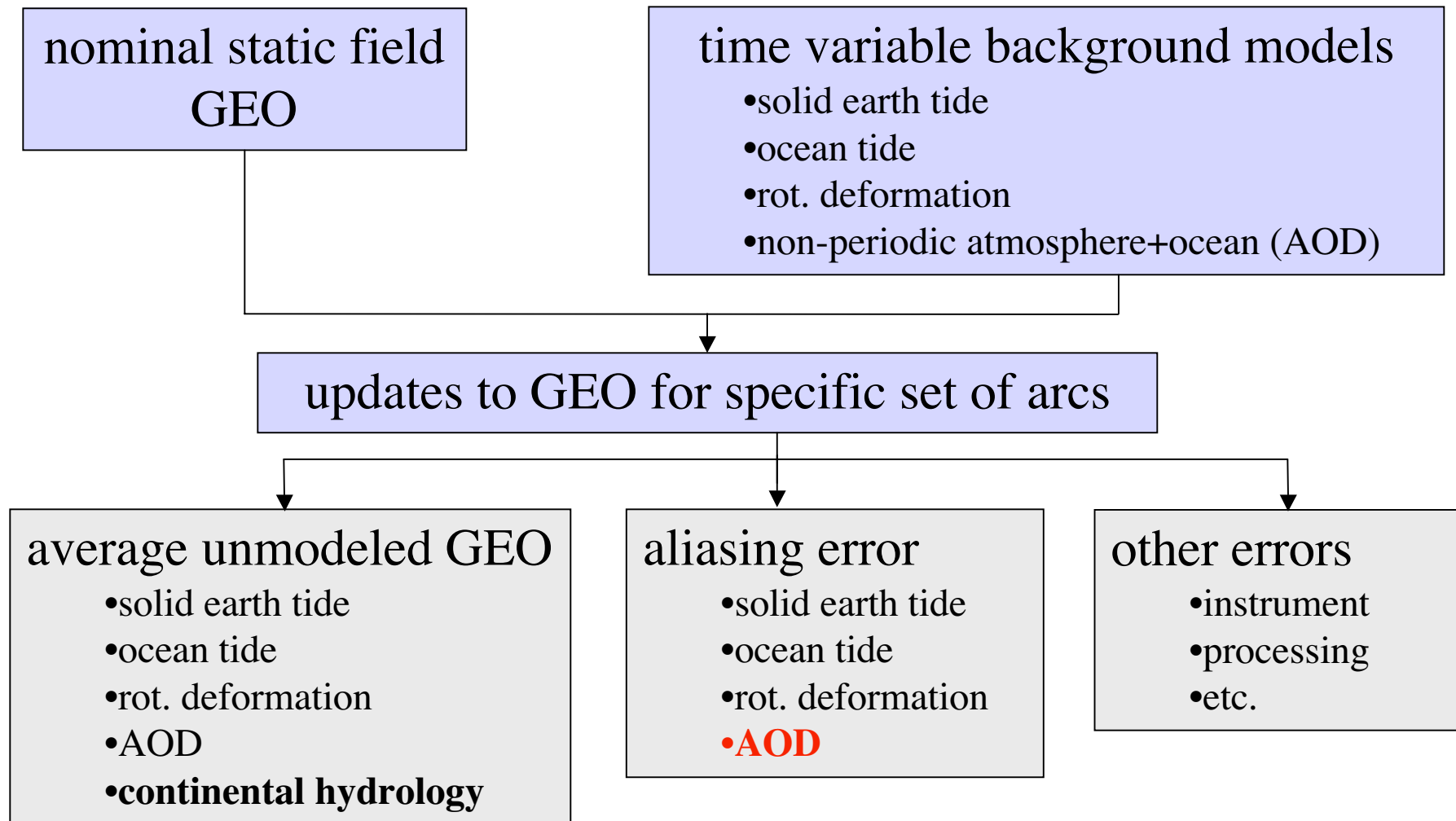

Aliasing/de-aliasing overview

Simulation results show the following for non-periodic variations of atmosphere and ocean:

- The very low degrees ($\sim 2-4$) are “correctly” recovered regardless of the de-aliasing
- However, there is a measurable and significant impact on the estimates of mid degrees and higher

Aliasing/de-aliasing overview

Impact of using AOD1B inputs in GRACE processing:

- Small, but consistent improvement in orbit fits
- Very small, but consistent reduction in KBR residuals
- Orbit tests show improvement for spacecraft particularly sensitive to mid-degrees
- Oceanographic circulation tests show small but consistent improvements in meridional currents

Aliasing/de-aliasing overview

Average of AOT1B for an August 2002 solution

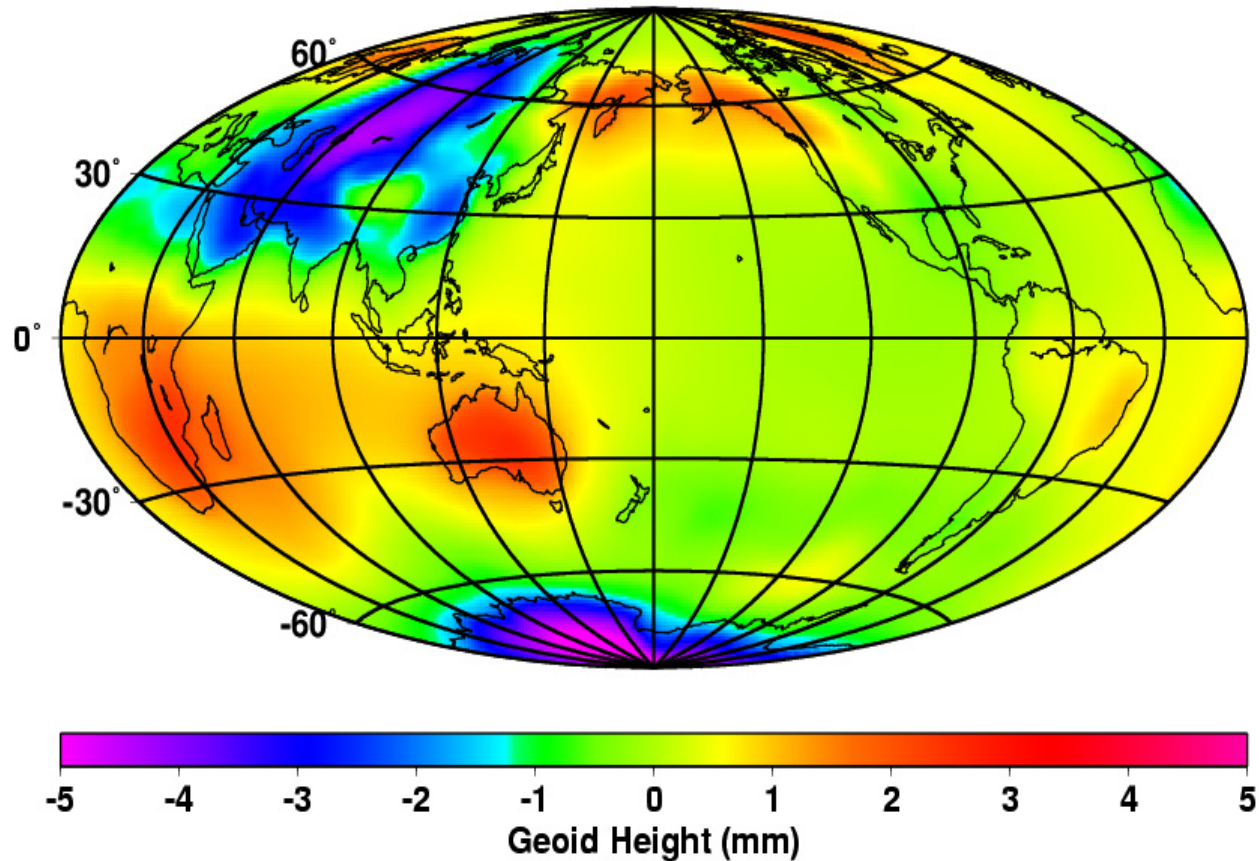

Aliasing/de-aliasing overview

History of geoid height along track, AOT1B
an August 2002 solution

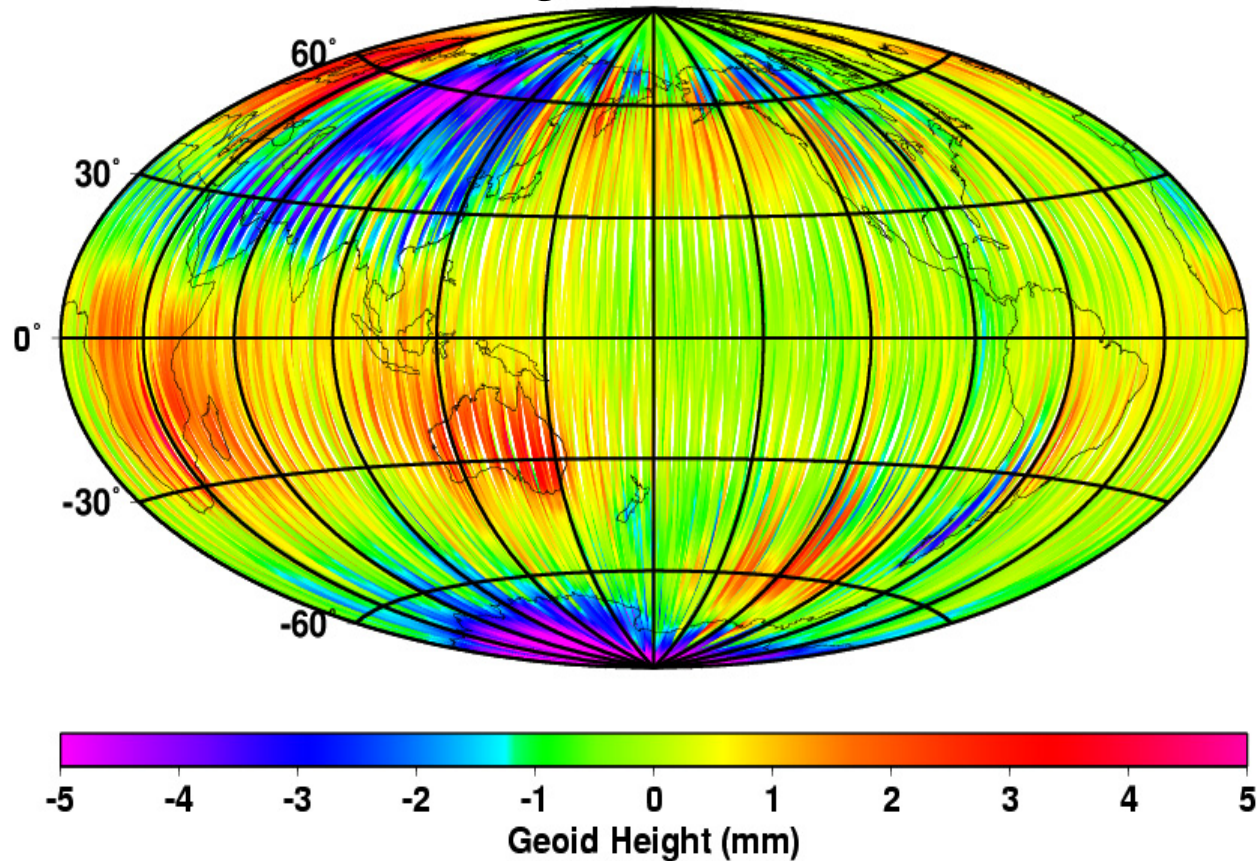

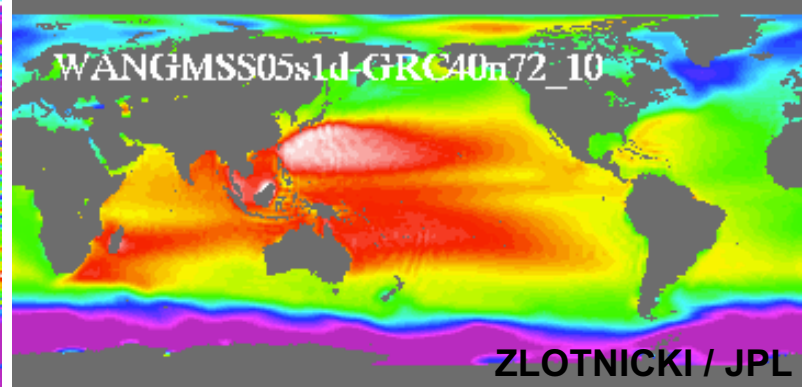
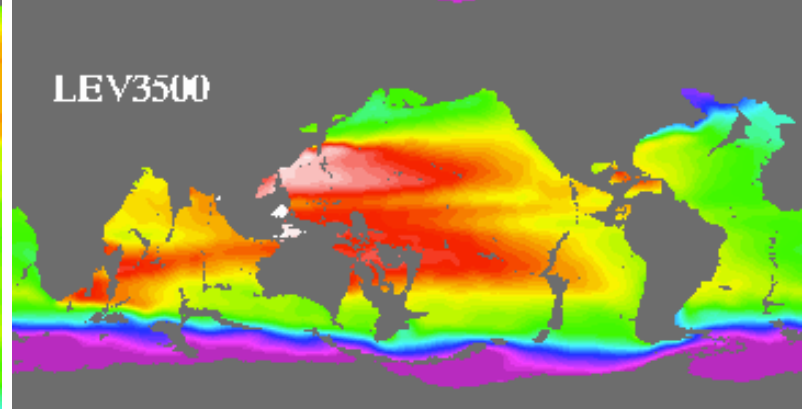
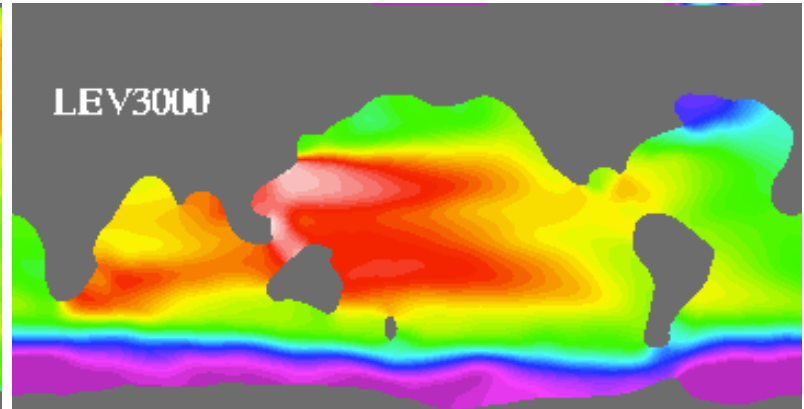
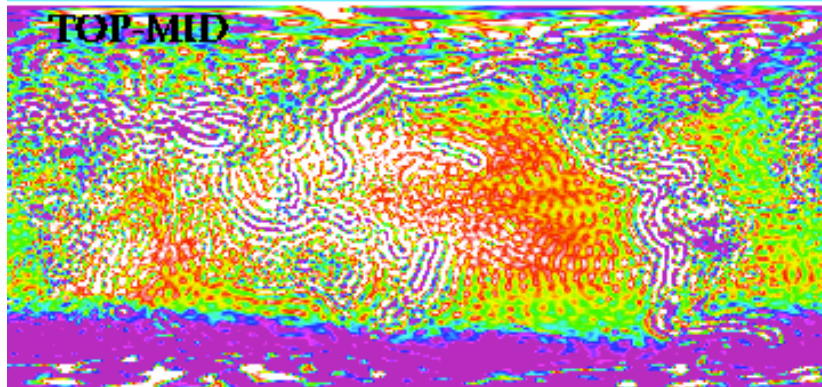
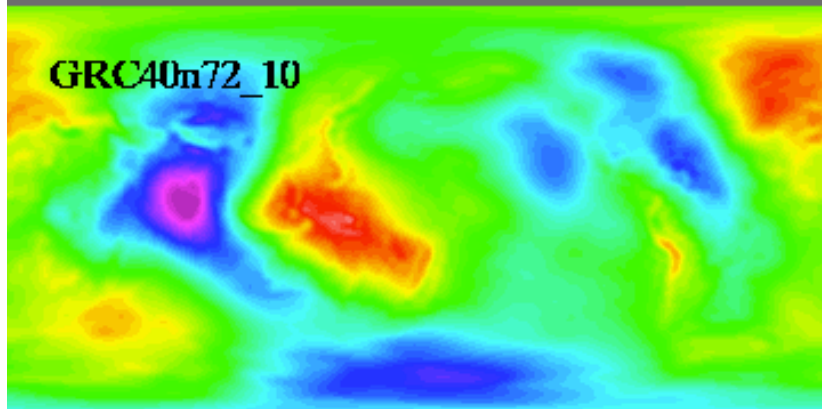
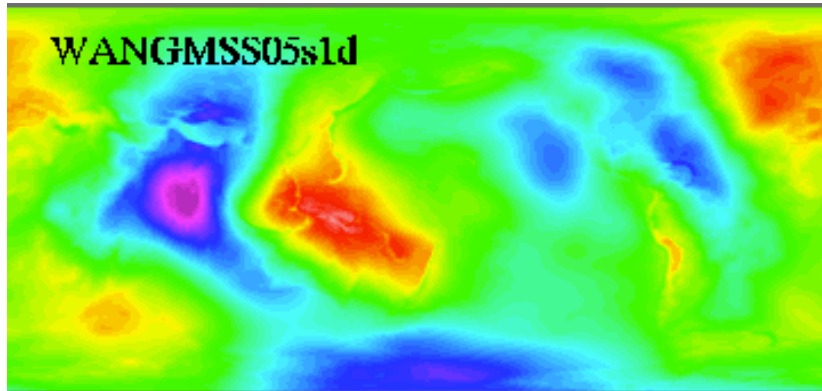

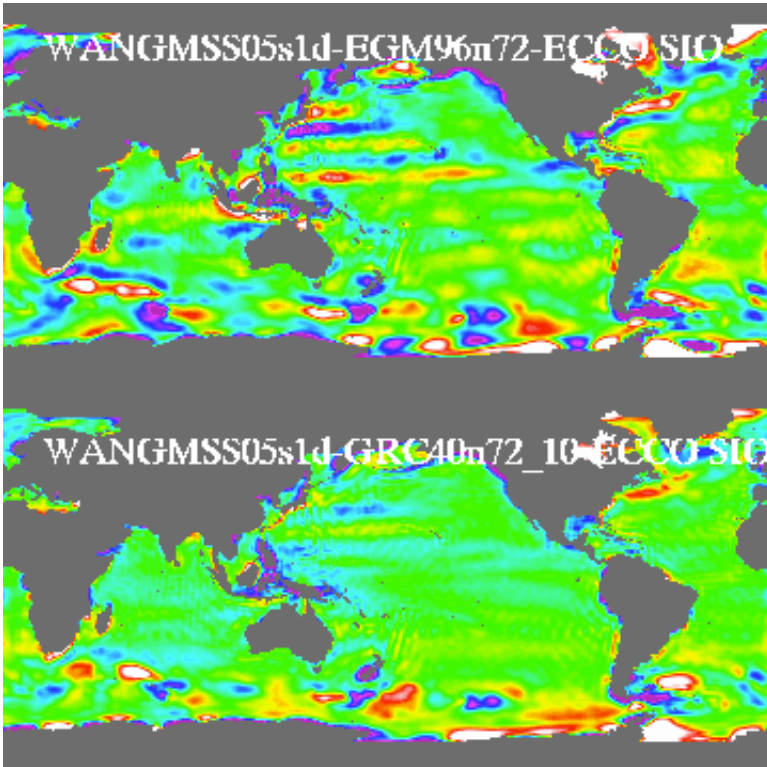

0.108 -0.90 1.57 LAT=[-75:+75]
 0.080 -0.86 0.99 LAT=[-75:+75]



0.112 -0.90 0.64 LAT=[-50:+75]
 0.081 -0.76 0.78 LAT=[-50:+75]

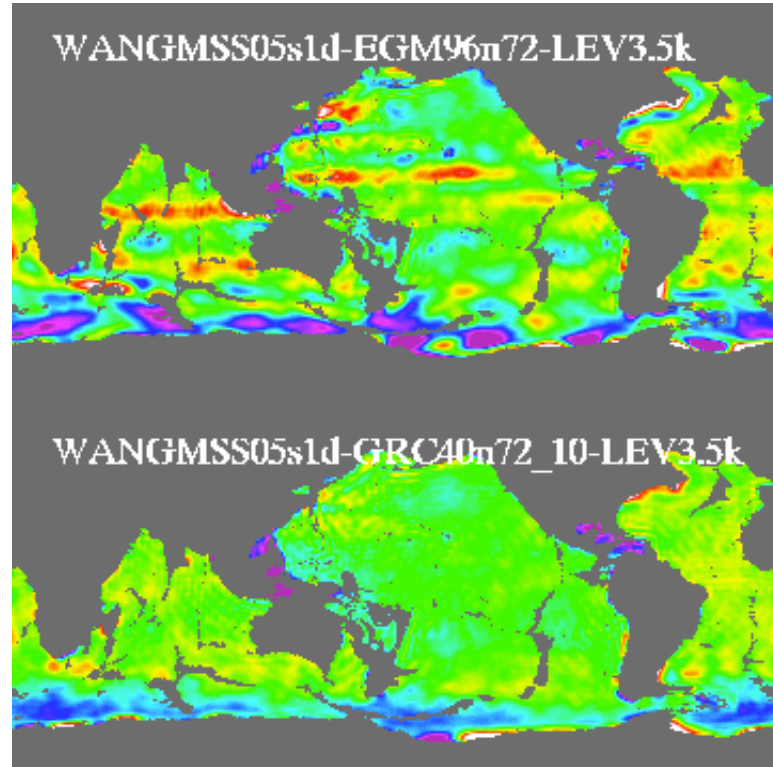

0.091 -0.88 0.79 LAT=[-75:+75]
 0.065 -0.97 0.57 LAT=[-75:+75]



0.088 -0.88 0.51 LAT=[-50:+75]
 0.065 -0.97 0.31 LAT=[-50:+75]

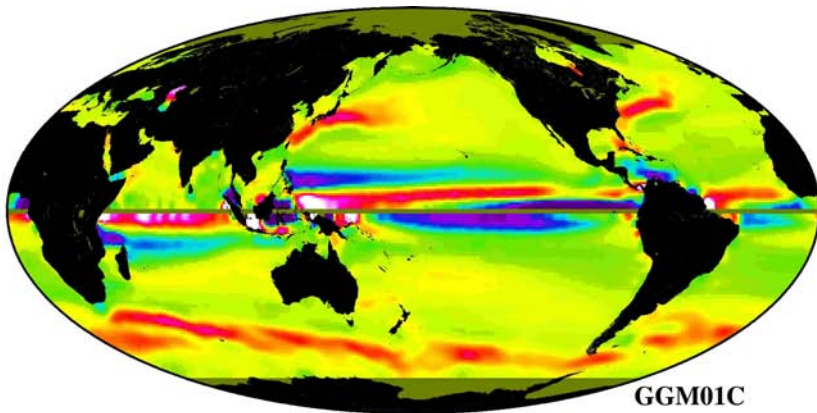

GGM01C

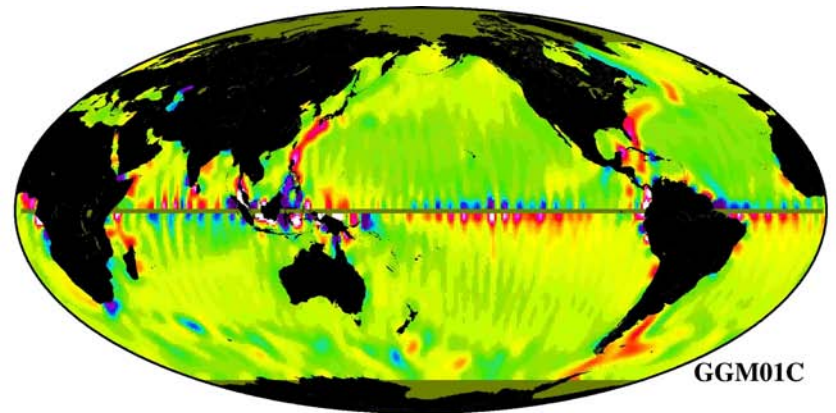

GGM01C

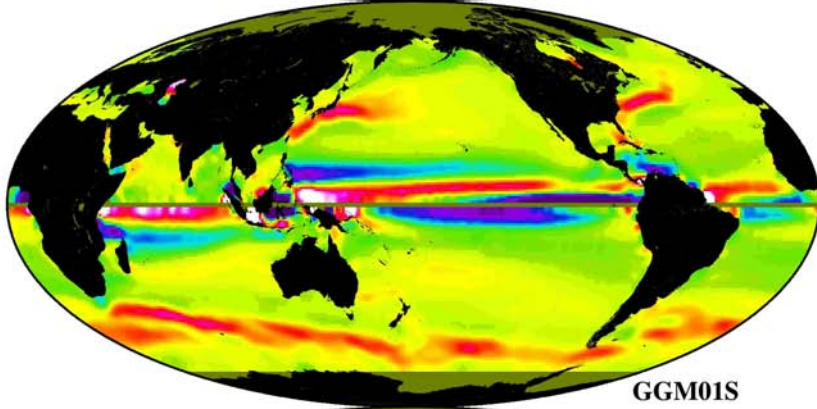

GGM01S

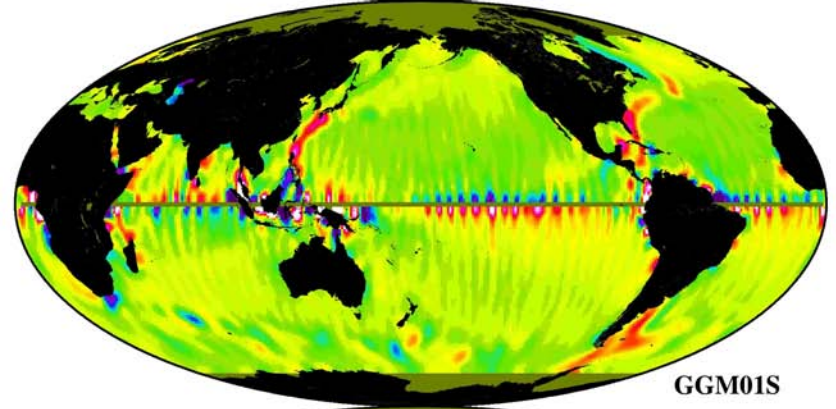

GGM01S

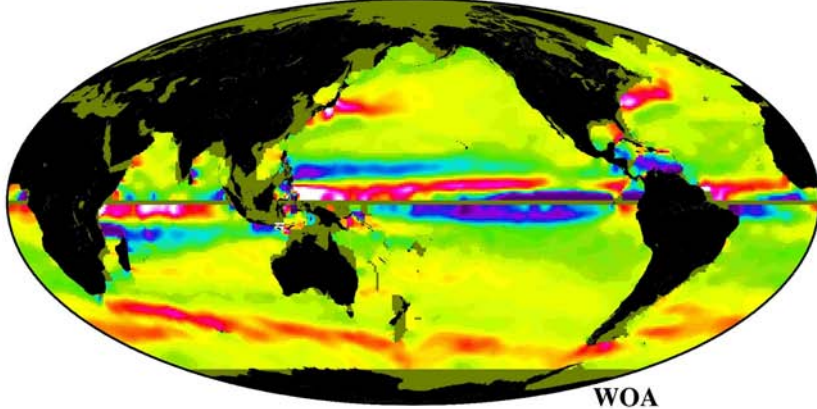

WOA

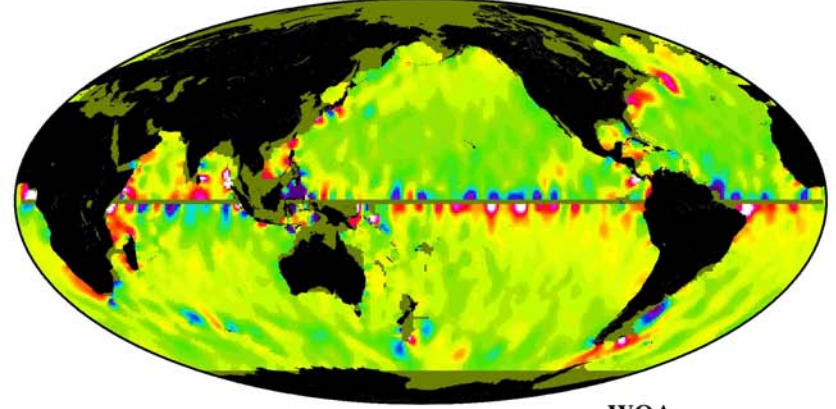

WOA

D. CHAMBERS / UT-CSR

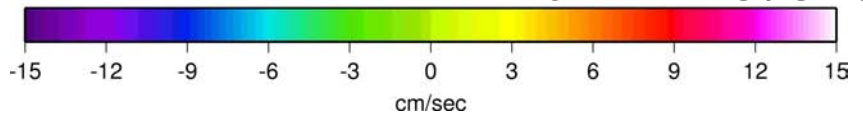
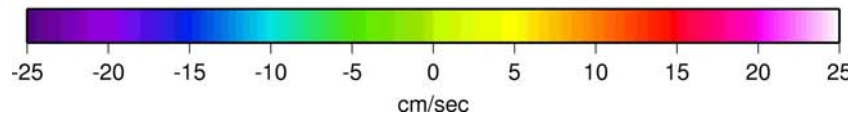

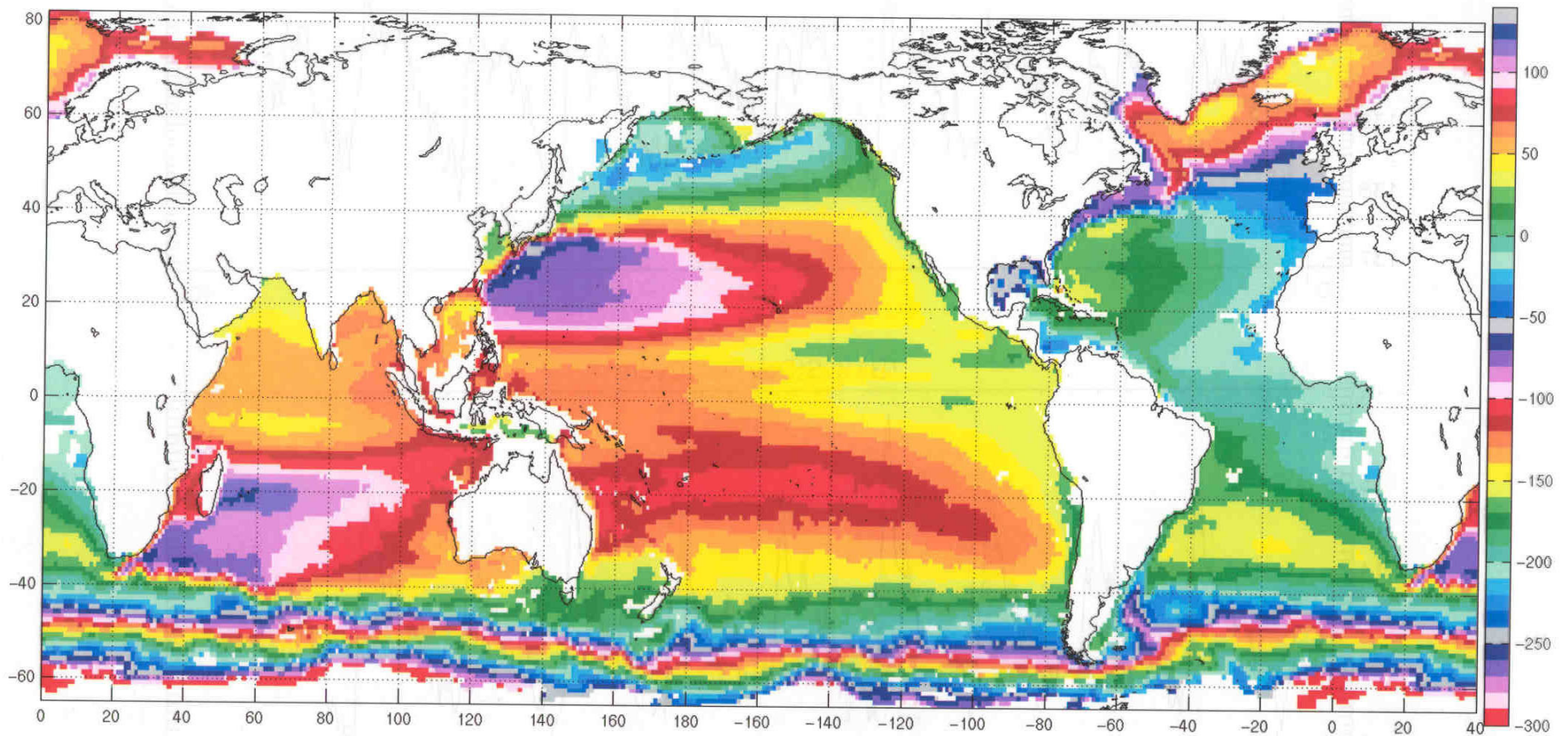

Absolute mean sea level (cm, optimized R&N99)

FROM SURFACE DRIFTERS

MAXIMENKO & NIILER / U.HAWAII / SIO

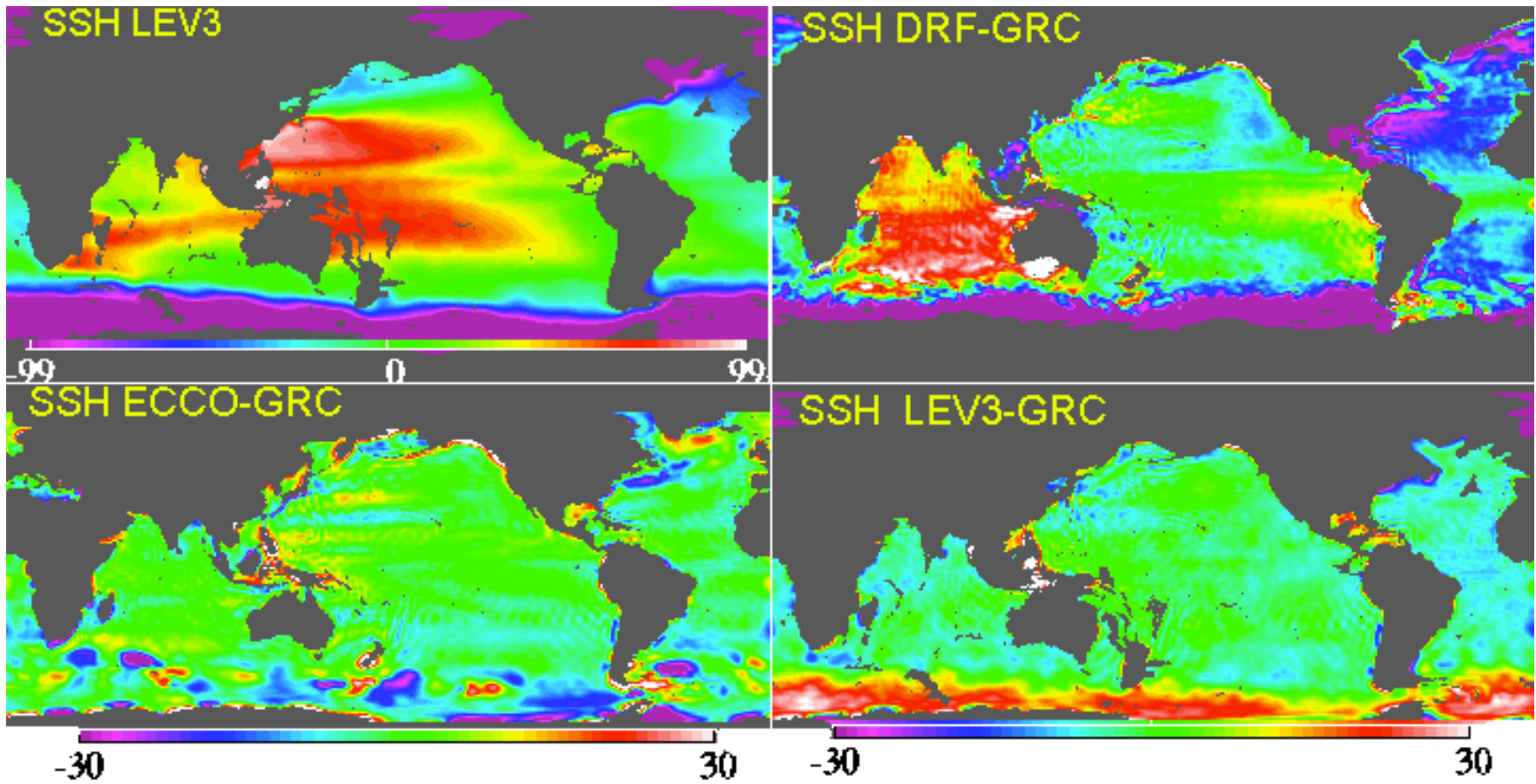

MAXIMENKO - ZLOTNICKI

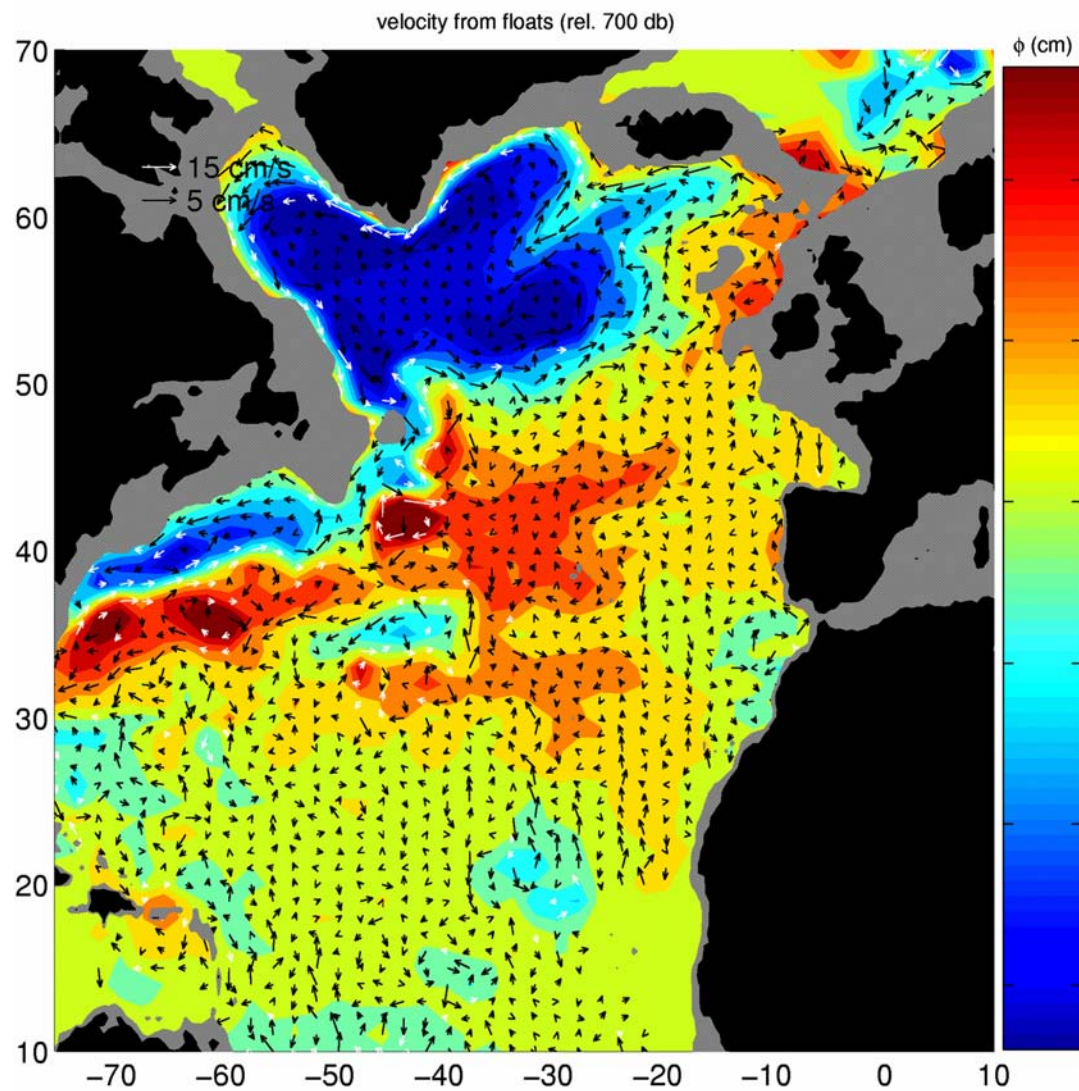

FROM DEEP FLOATS, 700 m

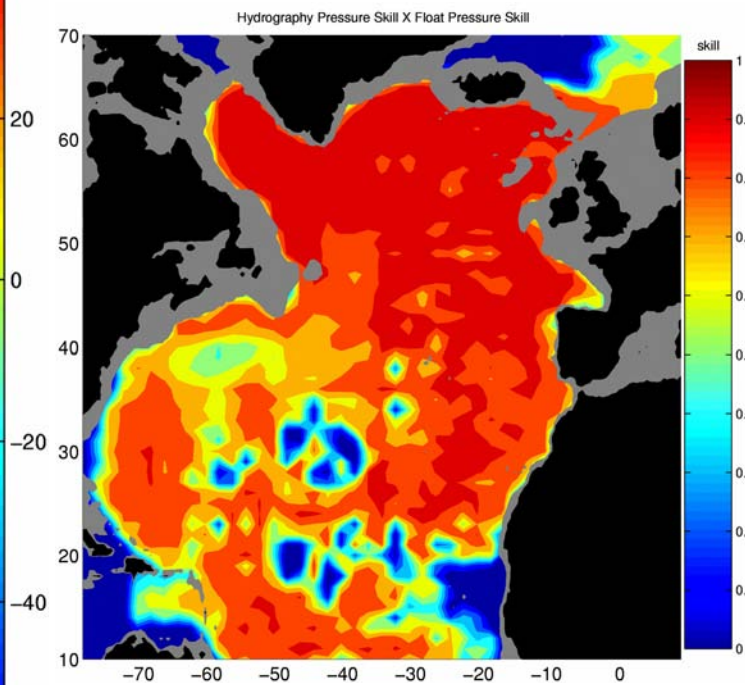

QUALITY DUE TO UNEVEN
COVERAGE

S. JAYNE / WHOI

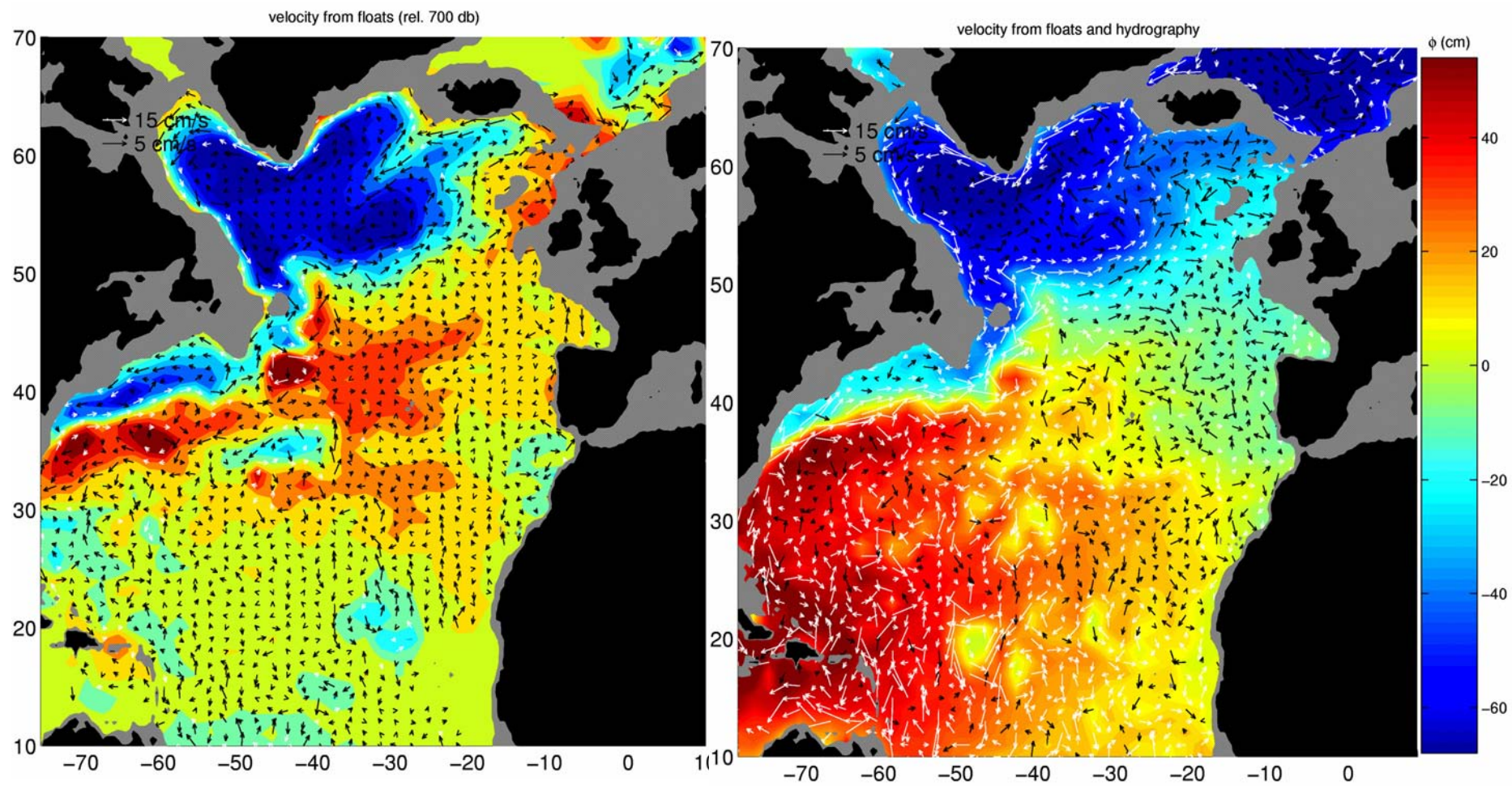

S. JAYNE / WHOI

- MSS-GGM01 has been compared to
 - Dynamic heights from LEVITUS T and S to 3, 3.5, 4 km (1940-1990)
 - Surface geostrophic velocities from LEVITUS (short wavelengths)
 - ECCO data-constrained numerical model sea surface heights
 - Dynamic Heights from an inversion of SURFACE DRIFTERS (must remove the Ekman component of surface velocity).
 - Geostrophic velocities at 700 dB from ARGO FLOATS.
 - (Alfred Wegener Inst. for Polar & Ocean Physics, data-constrained Model)
- People who looked: [Chambers](#), [Jayne](#), [Schroeter](#), [Zlotnicki](#).
- Special care to spatially filter MSS, GGM01, OCEAN data to match.
- MSS : CSR or GSFC or CLS, all represent oceans in 1990s.
 - **At this point, the main differences between MSS-GGM01 and ocean datasets or models are topics of interest in ocean circulation not errors in either MSS or GGM01.**



ICESat Status

B. E. Schutz,
Center for Space Research
University of Texas at Austin
schutz@csr.utexas.edu

October 8, 2003

GRACE Science Team
Austin

1



Overview



- Background
- ICESat and laser altimeter description
- Science requirements and instrument/mission design
- Mission status
- Calibration/validation
- Laser altimetry examples

ICESat



- Ice, Cloud and land Elevation Satellite (ICESat) launched January 13, 2003 00:45 UTC from Vandenberg (CA) on Delta-II
- Primary instrument on ICESat is GLAS (Geoscience Laser Altimeter System)
- NASA Earth Science Enterprise mission
 - GLAS is a NASA Goddard instrument
 - Spacecraft built by Ball Aerospace
 - Mission operations at LASP/University of Colorado
 - Science Team

October 8, 2003

GRACE Science Team
Austin

3

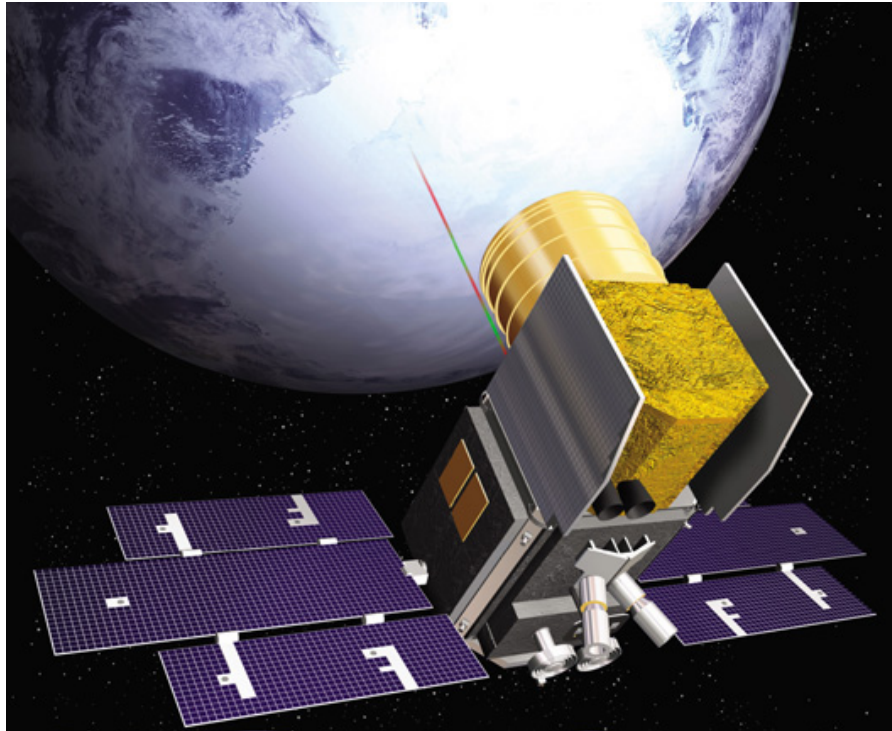

- Science goals:
 - Measure changes in polar ice mass balance
 - Map land topography and sea ice, and vegetation canopy information
 - Measure distribution of clouds and aerosols
- GLAS lasers produce a 1064 nm beam (surface altimetry) and a 532 nm beam (atmospheric lidar)

GLAS

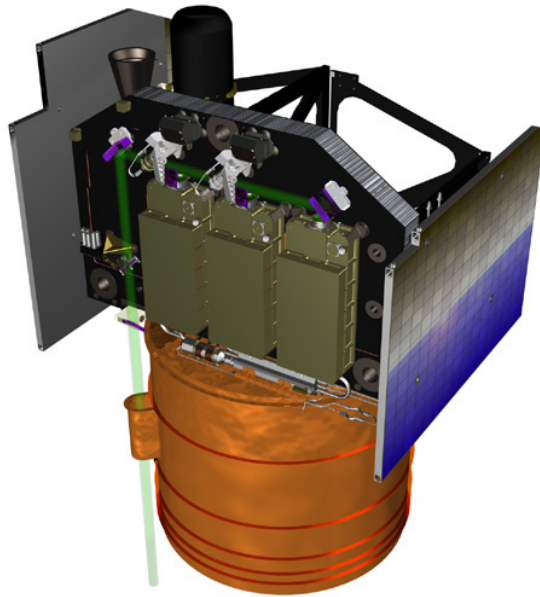

- Three lasers; one operates at a time; each transmit at 1064 nm and 532 nm
- Continuous operation @ 40 Hz
- Laser spot on Earth's surface: ~70 m diameter
- Spot separation on surface: 170 m
- Laser pointing direction is near nadir; spacecraft supports off nadir pointing ($<5^\circ$) at targets of opportunity and reference ground tracks

Measurement Concept

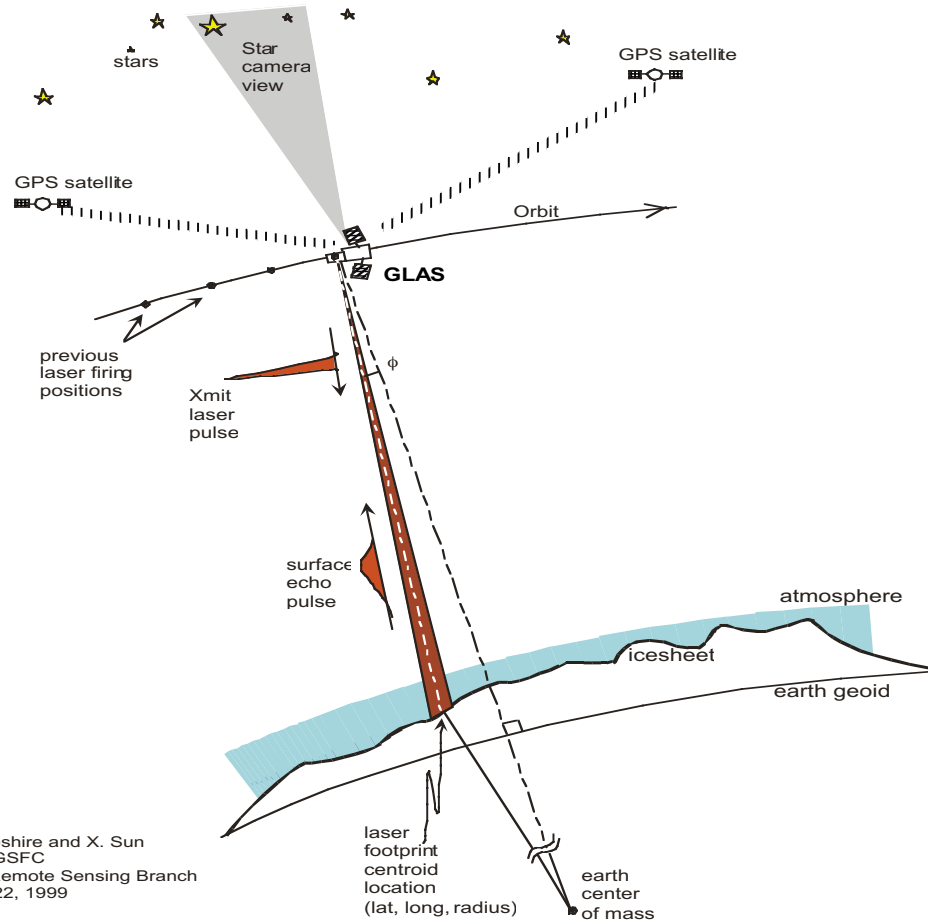

- Surface profile obtained from determination of laser spot location on Earth's surface
- Laser spot geodetic coordinates inferred from:
 - POD (GPS+SLR): gives position vector of GLAS reference point (Req: <5 cm radial)
 - PAD (star trackers/gyros) plus laser time of flight gives altitude vector of GLAS reference point (Pointing Req: 1.5 arc-sec)

GLAS: Back in Operation!

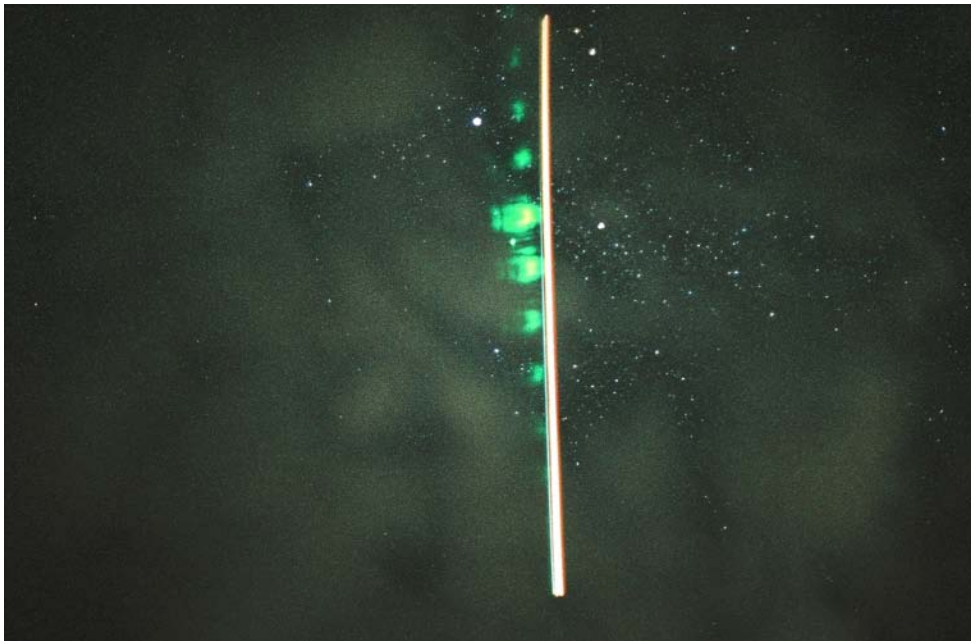

Ground photo at Bonneville Salt Flats, UT
on September 30, 2003 (CSR photo)

- Second GLAS laser began firing on September 25, 2003
- Performance of laser #2 has been very good
- Laser #1 abruptly stopped on March 28, 2003 after 36+ days of operation
- Review Board appointed to investigate anomaly
 - Report presented to NASA HQ in August
 - Recommended adjustments to Science Operations
- Return to laser operations delayed until September 25 by Hurricane Isabel, etc.



Status



- Laser #1 operated from Feb 20, 2003 to March 28 (36+ days)
- Laser #2 activated on Sept 25, 2003 (performance is significantly better than laser #1)
- GPS (BlackJack) receiver #1 has been operating continuously since a few days after launch (except for a several hour period in May); receiver #2 not been powered on
- SLR measurements acquired during laser #1 operations; demonstrate that GPS-derived orbit accuracy is 2 cm level radial (GRACE gravity field used for ICESat POD)

Laser #1 Pointing Calibration

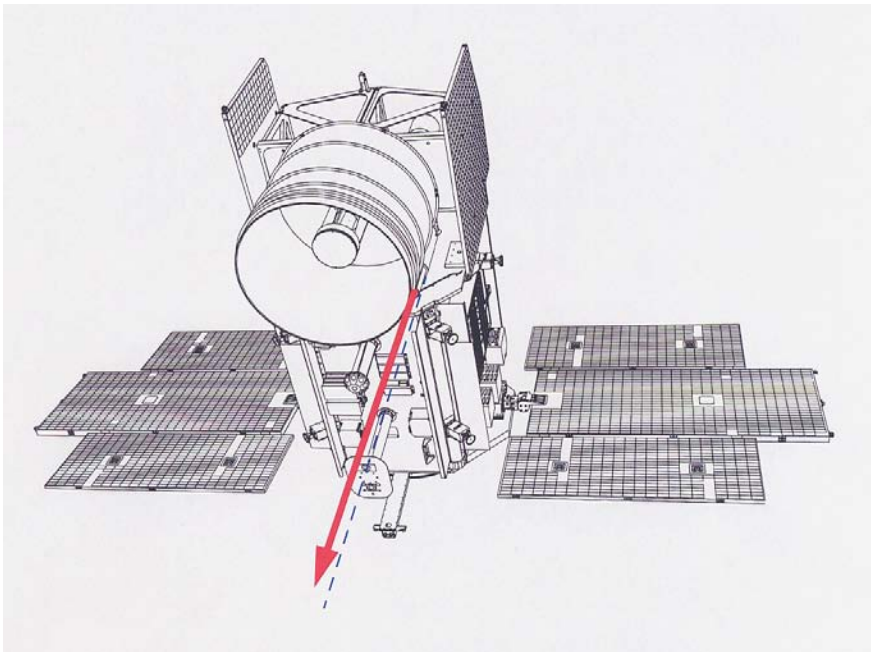

- Calibration/validation using laser #1 determined set of pointing offsets with respect to instrument coordinate system
 - Offsets applied in the data product generation (PAD)
 - Known remaining temporal variation (~ 15 arcsec); analysis with laser #2 expected to refine information about correction
 - One 8-day cycle from laser#1 expected to be released by end of October (remaining uncalibrated temporal variation in the release)

Laser #2 Pointing Calibration

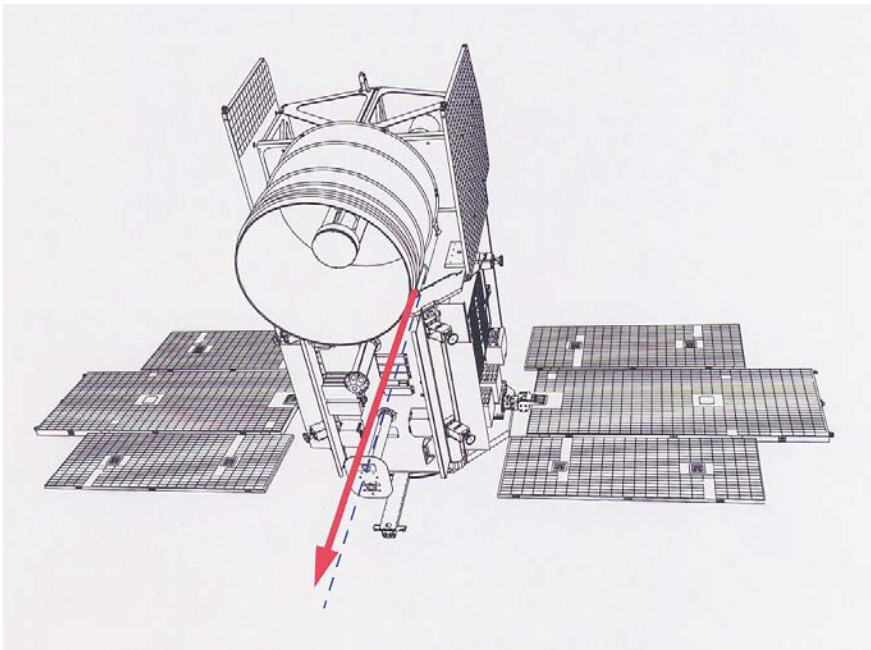

- Cal/val in progress
 - Preliminary results from different techniques are in agreement (meeting next week to review)
 - Demonstrated unambiguously that time tags are accurate to $\sim \mu\text{sec}$ (requirement is msec)

ICESat Orbit

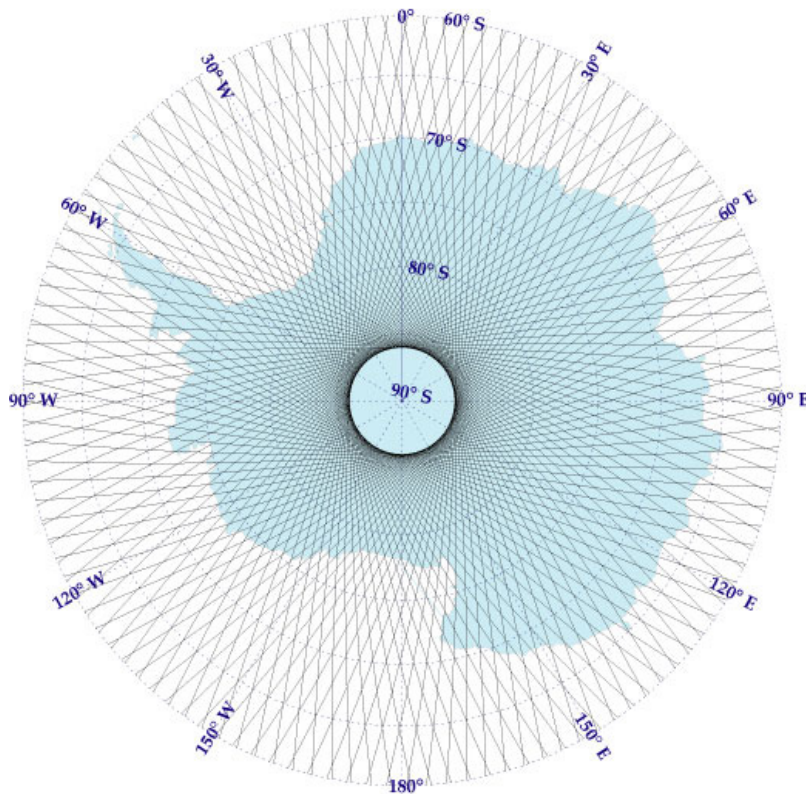

- ICESat 8 day repeat orbit (shown) supports cal/val
- Transitioned smoothly to 91 day repeat orbit after one 8 day cycle with laser #2
 - ~ 30 day subcycle
 - Laser operations reviewed based on results of anomaly investigation of laser #1
 - Plan is to operate through approximately one subcycle, then power off laser (early November)
 - Power laser back on in spring, 2004 for ~30 days; repeat in fall

Antarctic Profile

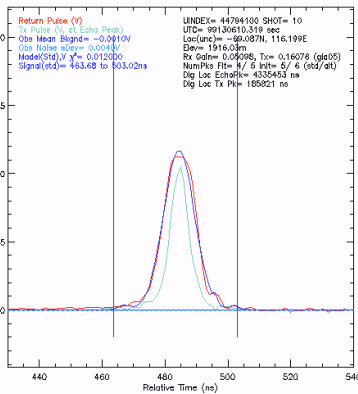
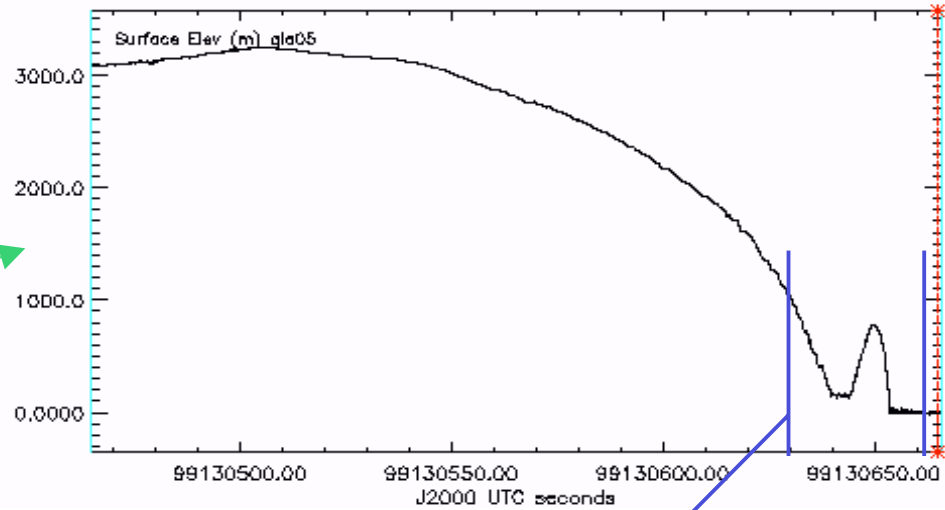
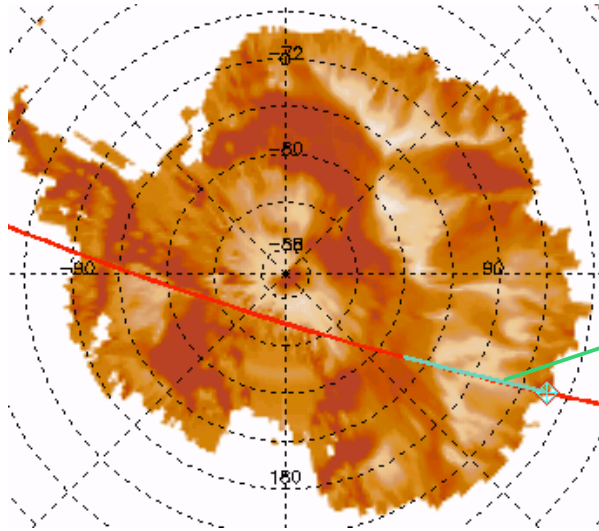

Preliminary
 data-ICESat
 Science Team

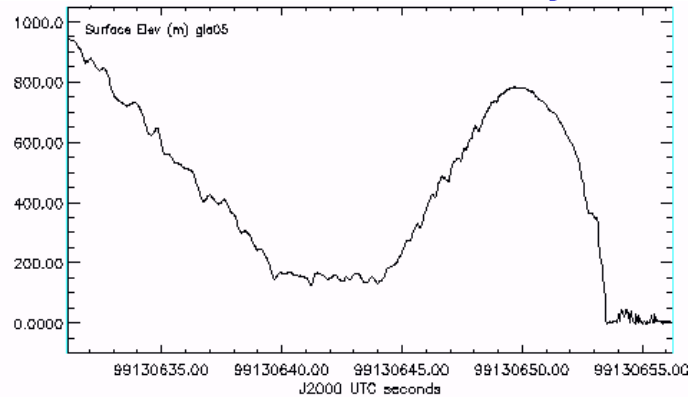

October 8, 2003

GRACE Science Team
 Austin

Amery Ice Shelf: LANDSAT Image

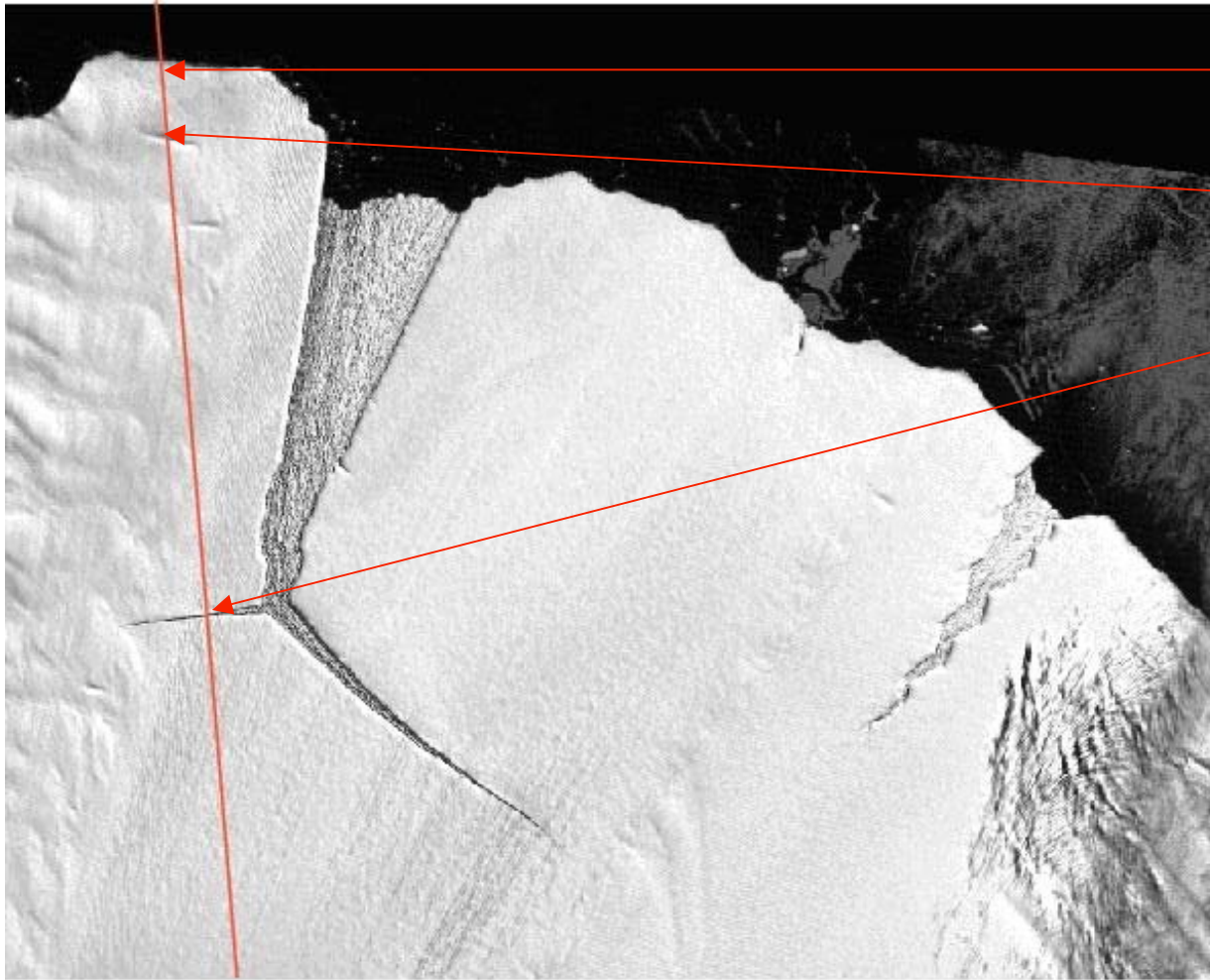

Ice shelf edge

Crevasse

Rift

GLAS Science Team:
UCSD/Scripps

Direction of Motion

Amery Elevation Profiles

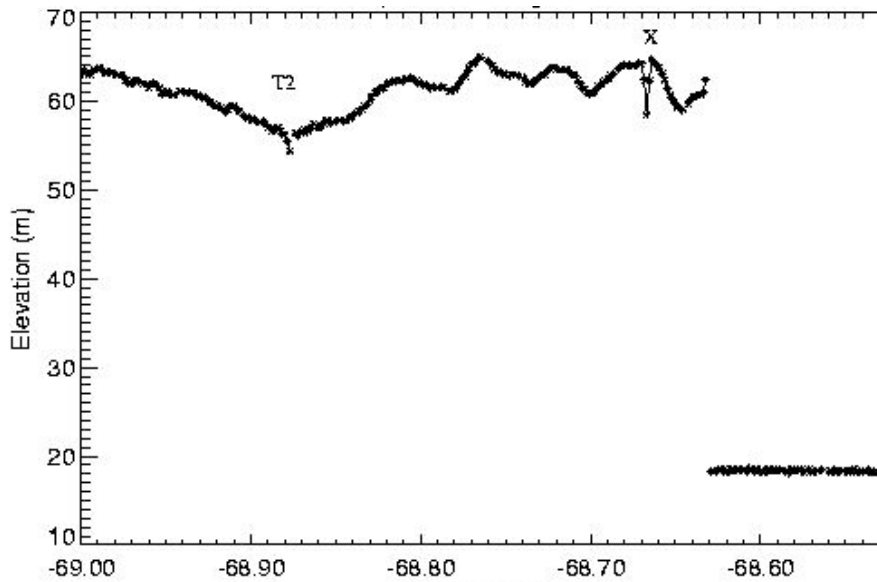

Direction of motion

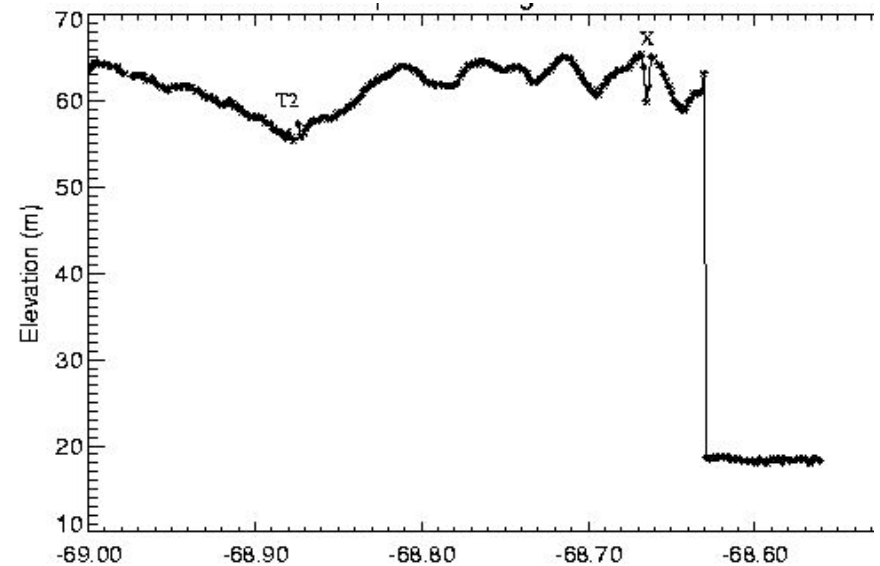
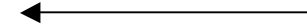

- Two “repeat” tracks shown
- Tracks separated by few hundred meters in east/west
- Features clearly evident

A Green Channel View

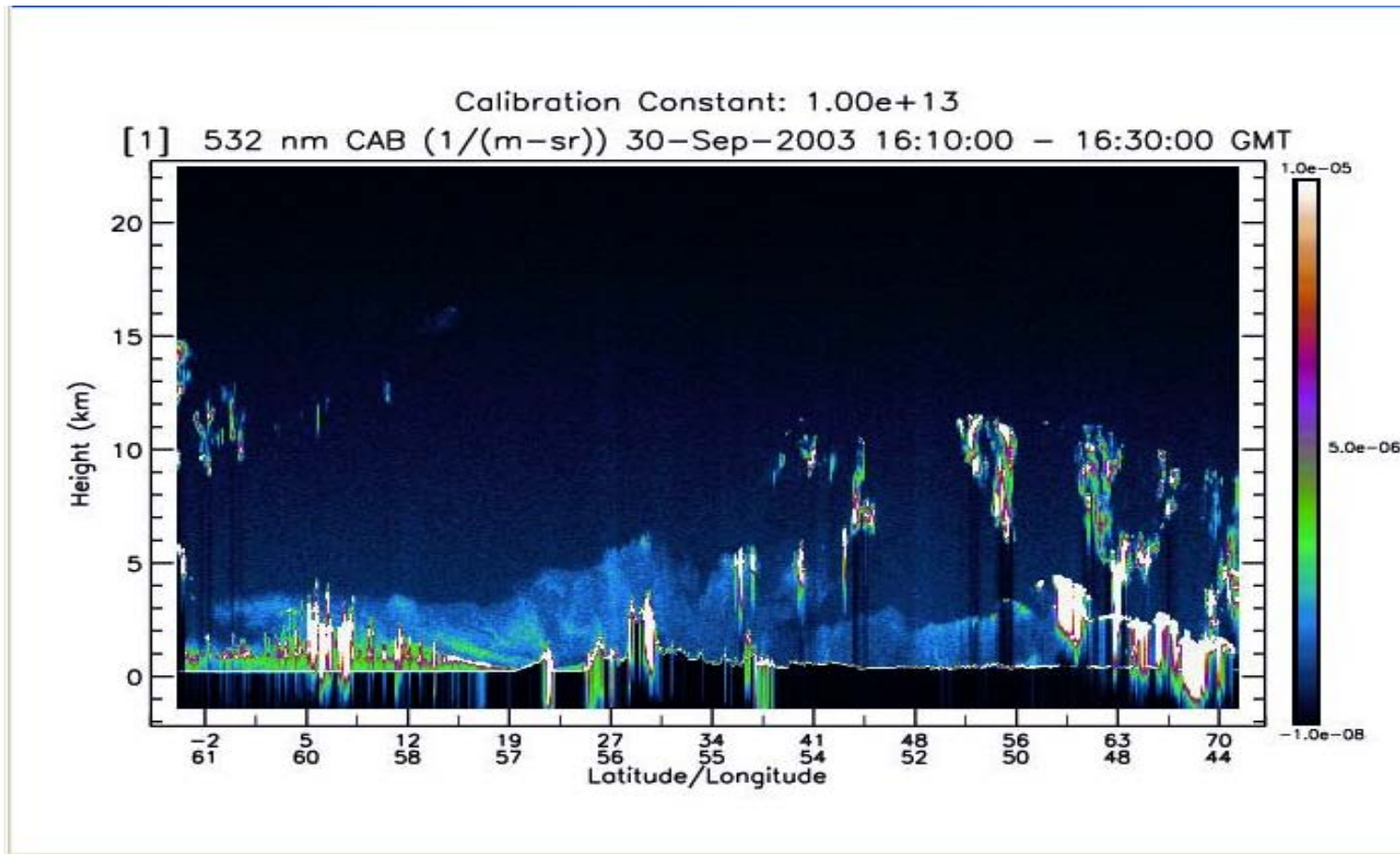



Integrated Sensor Analysis GRACE

B. Frommknecht¹, R. Rummel¹, F. Flechtner²

¹Institute for Astronomical and Physical Geodesy
Technical University of Munich

²GFZ Potsdam

GRACE Science Team Meeting, October 8-10, 2003
Austin, TX



- 1. Performance of the K-Band System**
- 2. Performance of the Star Sensor System**
- 3. Performance of the Accelerometer**
- 4. Combination of K-Band and Accelerometer measurements**

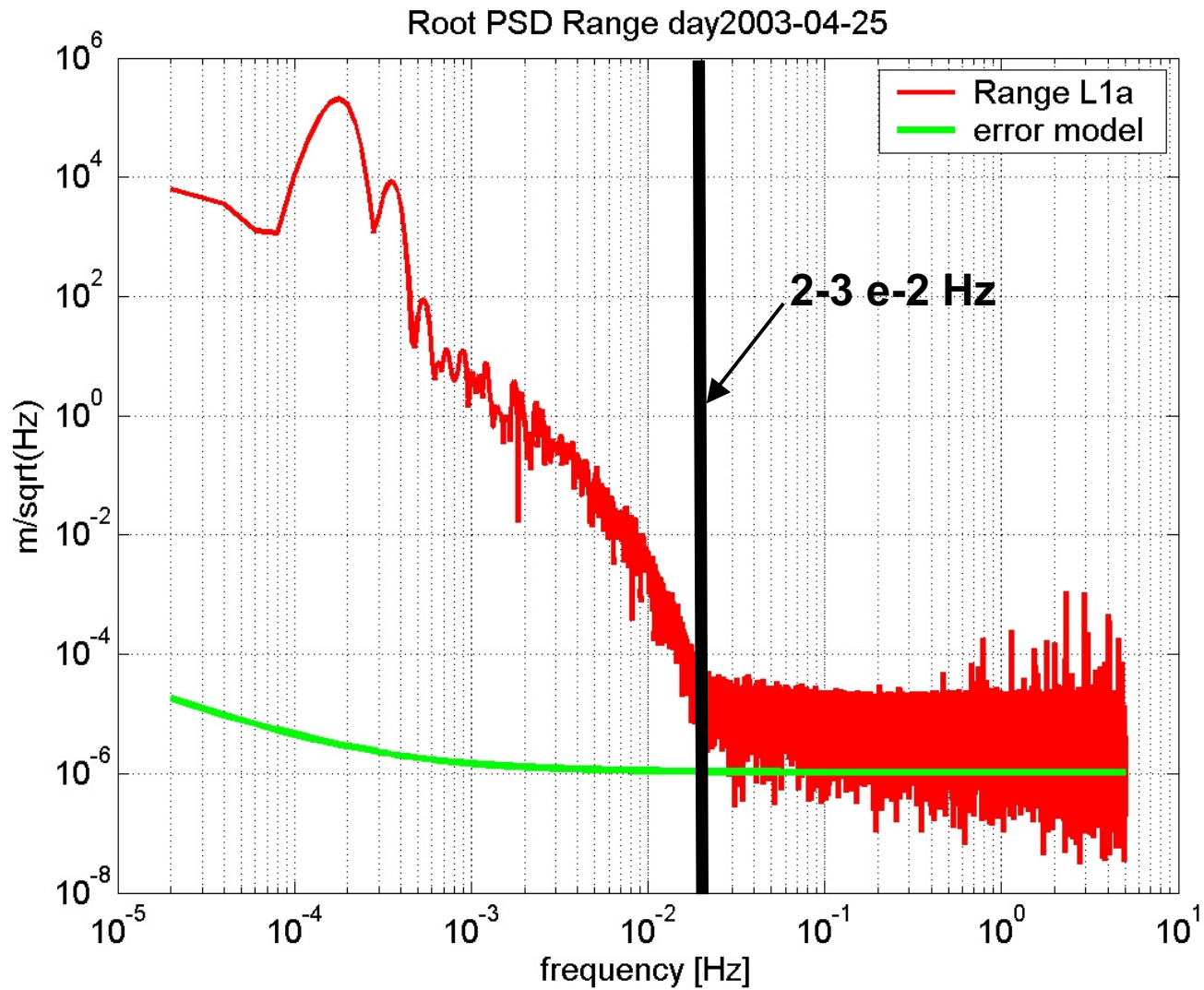

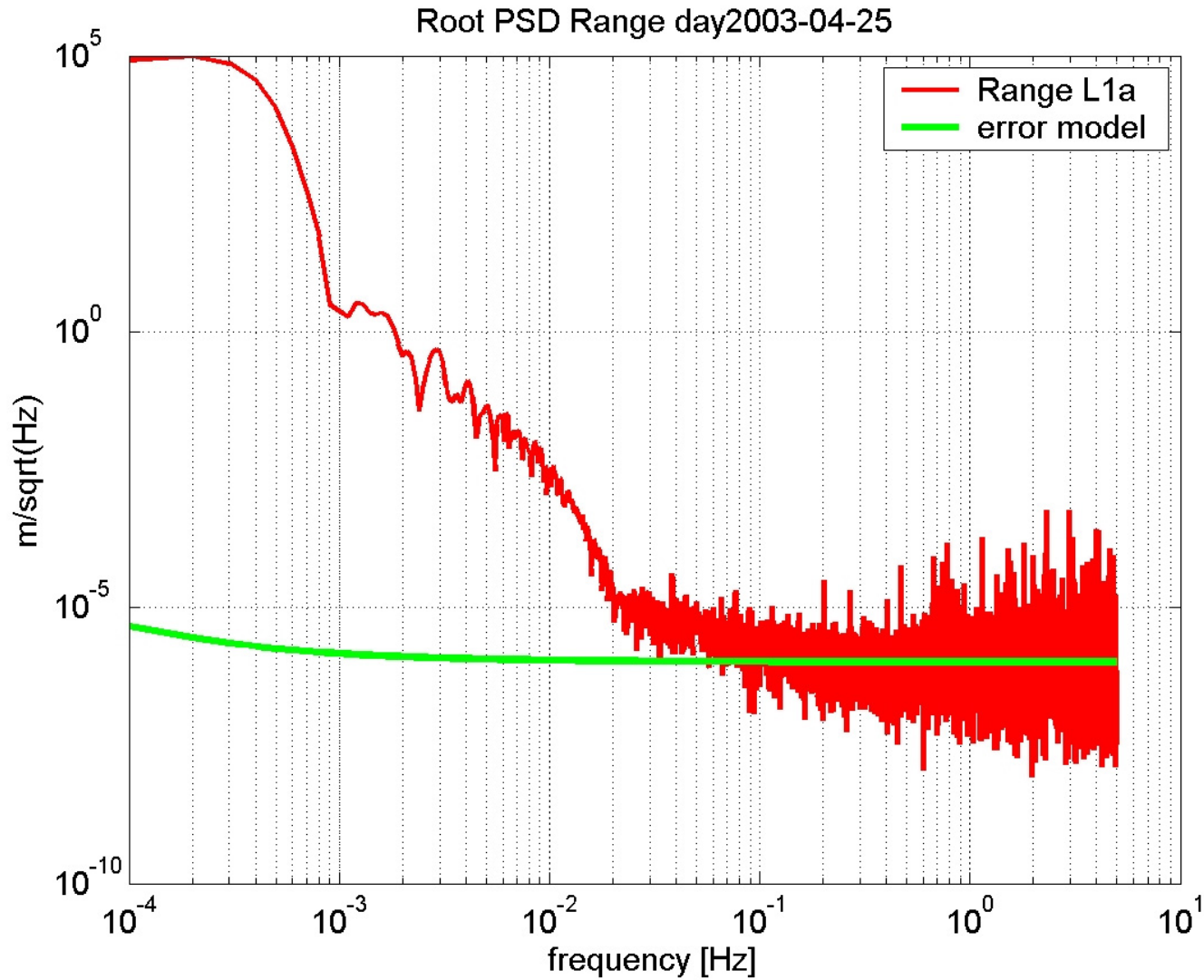

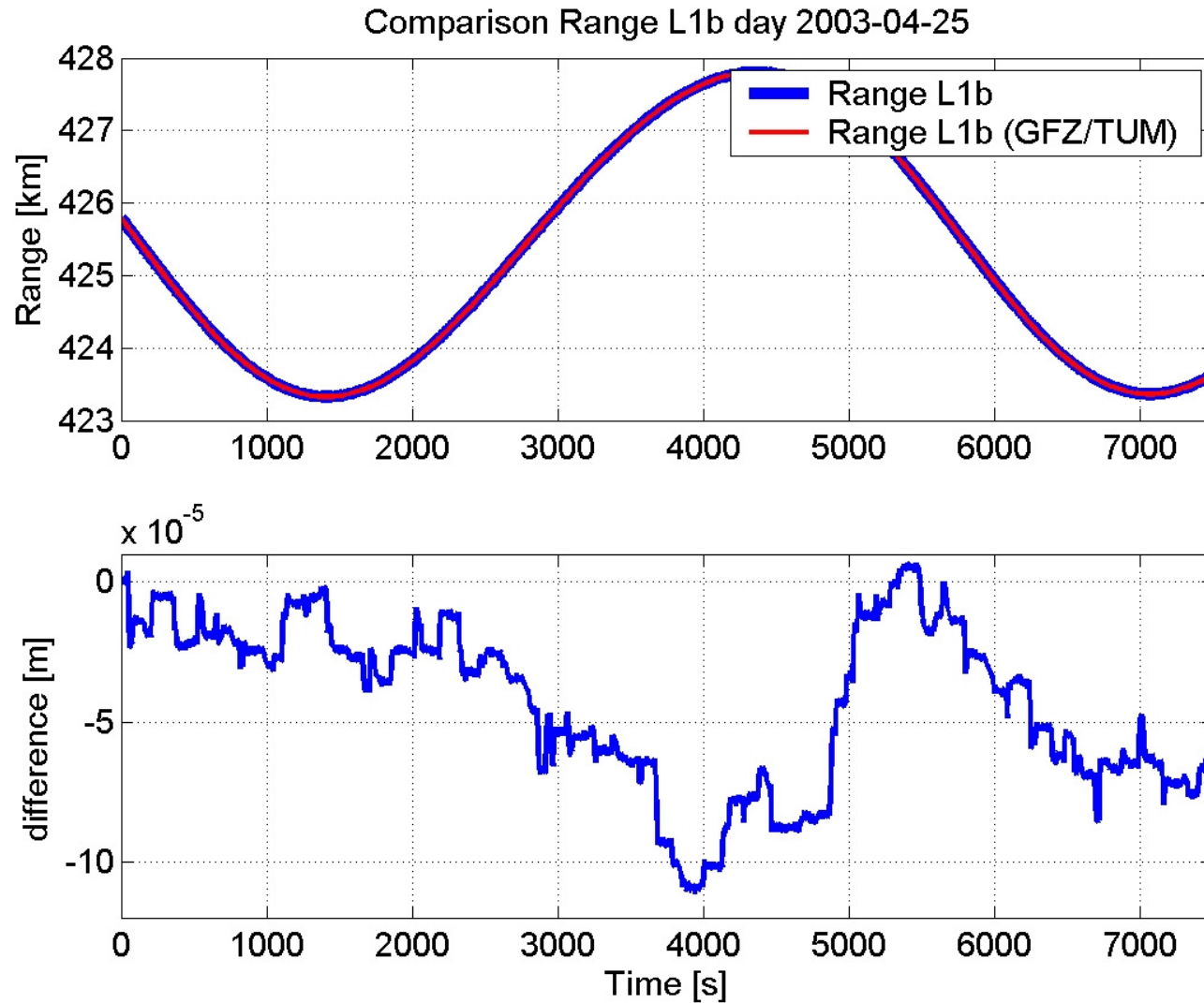

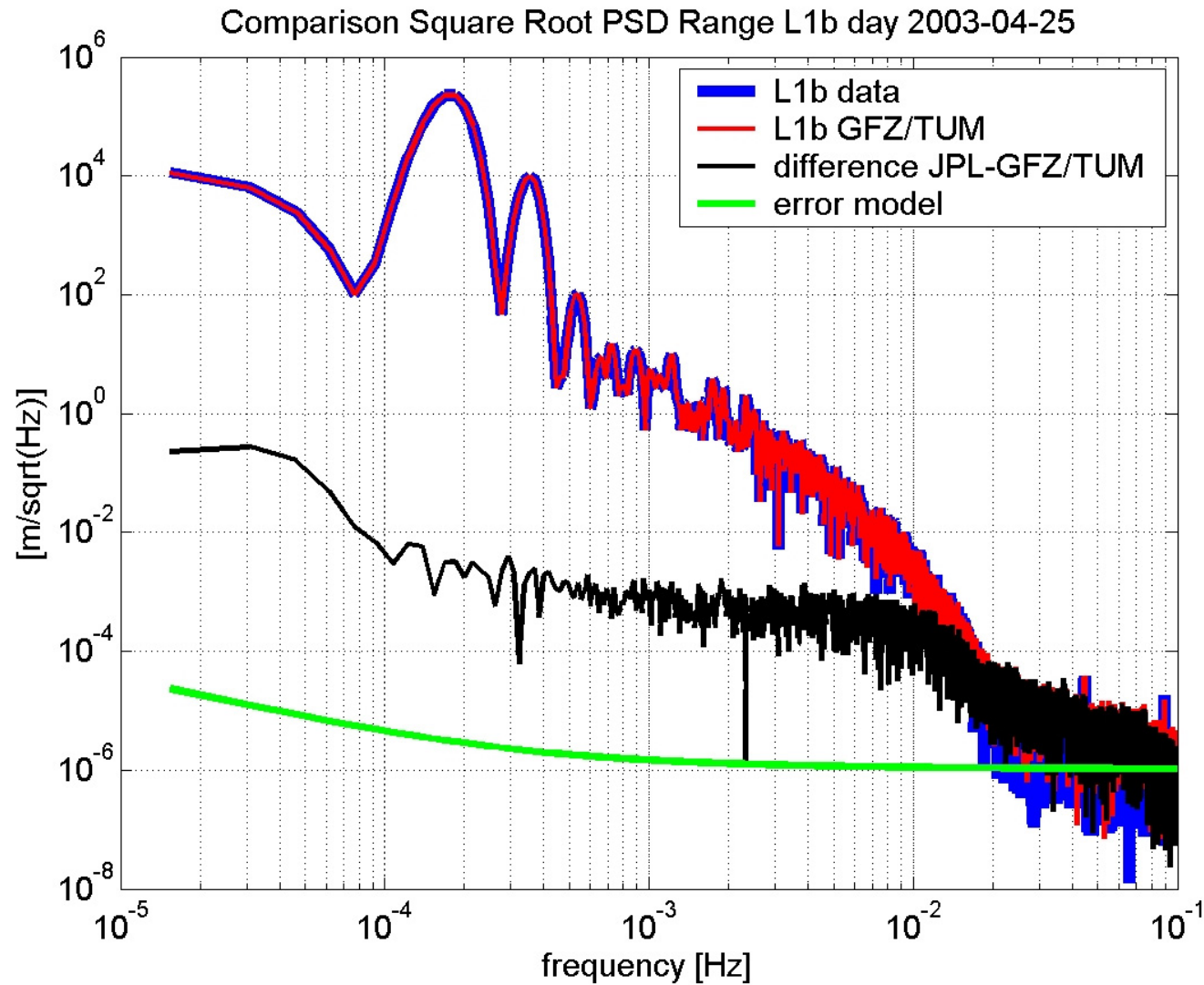

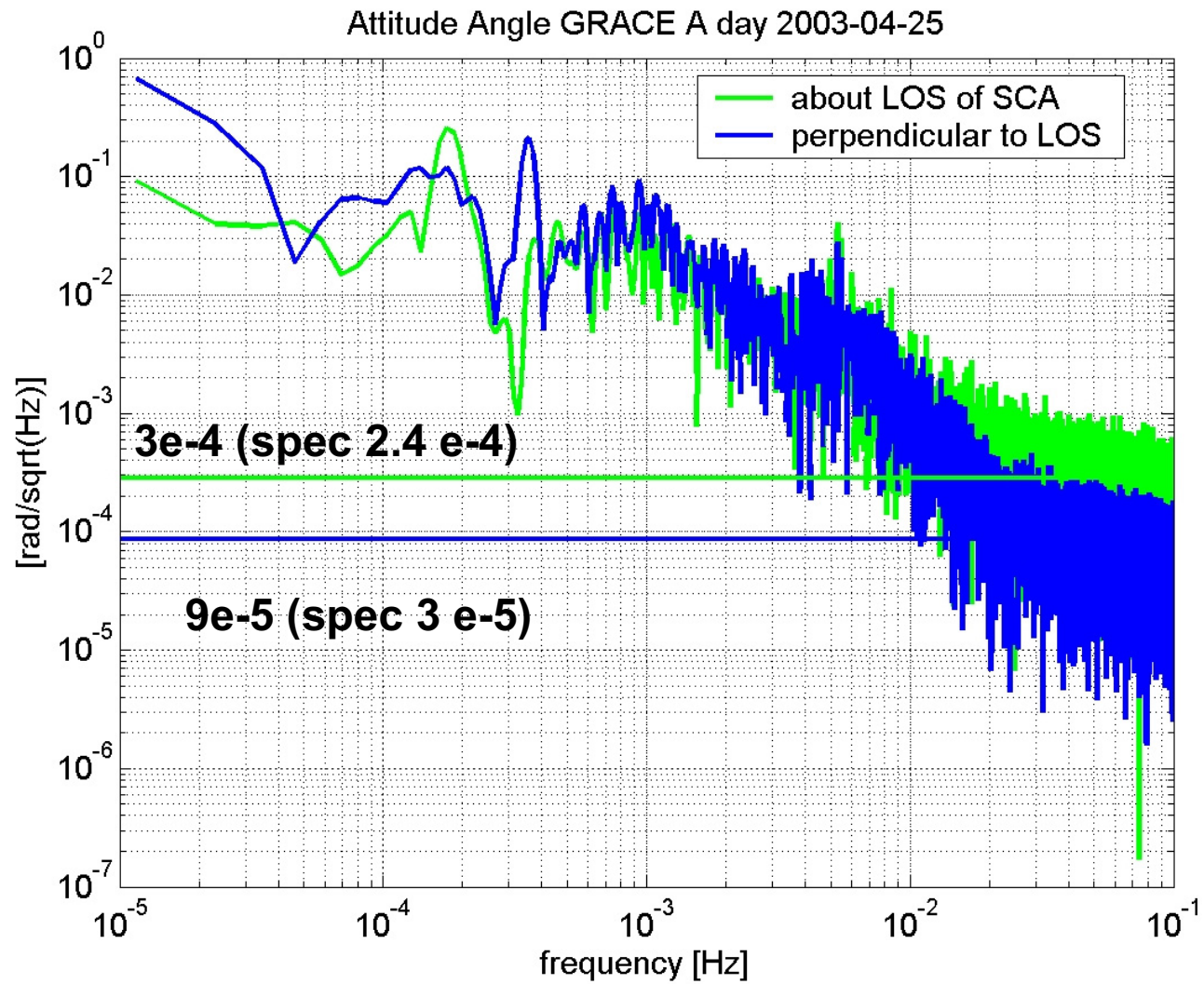

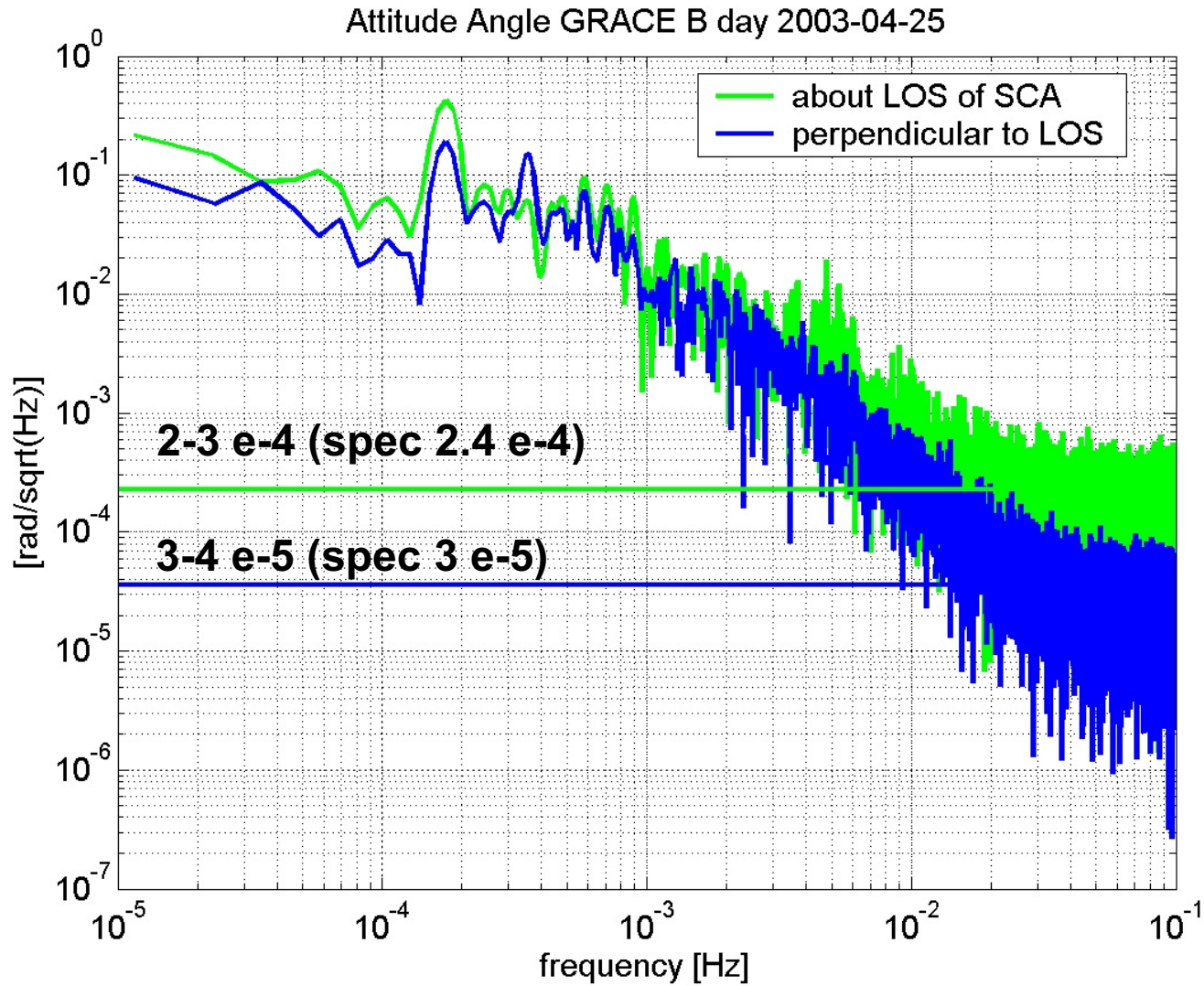

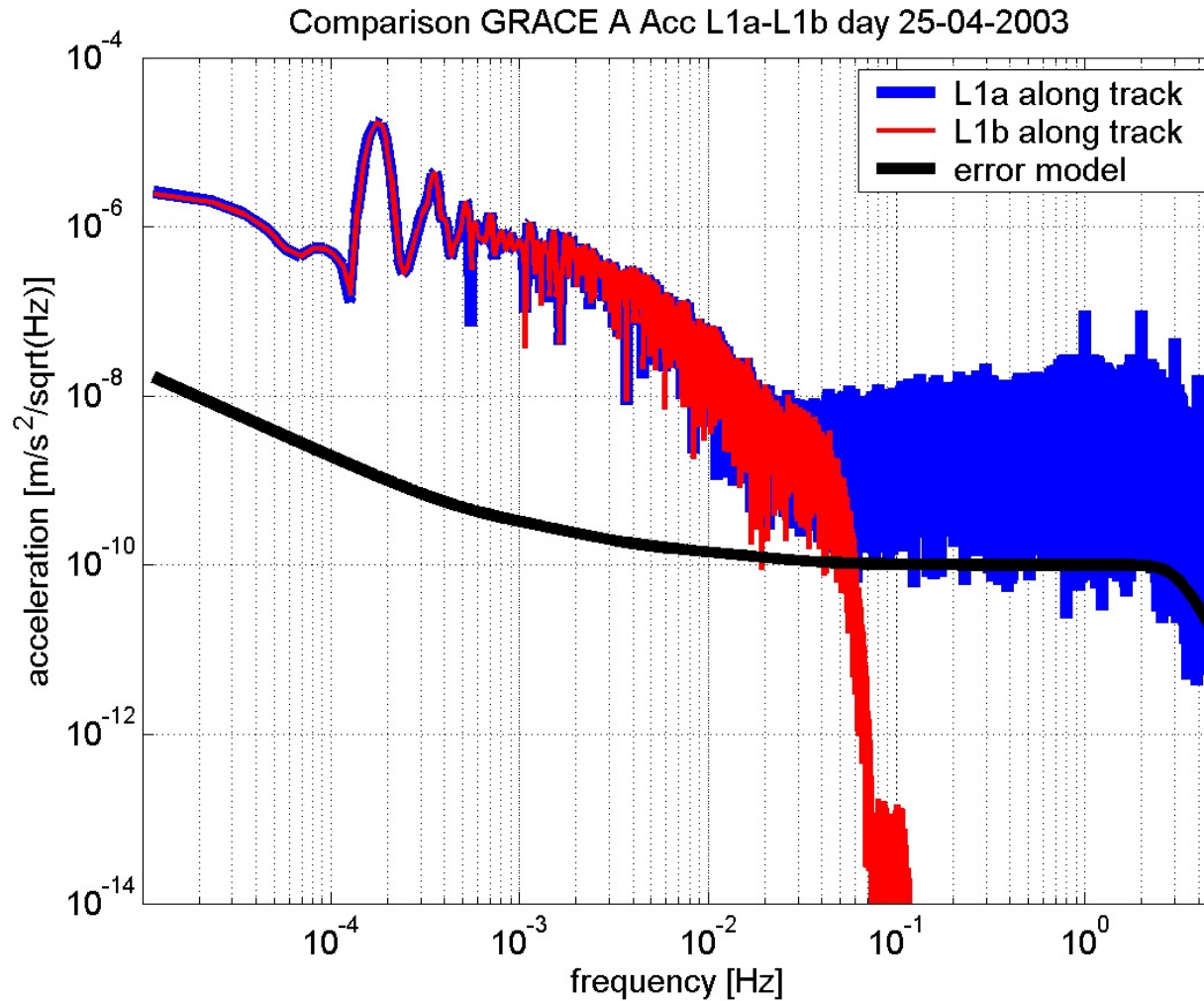

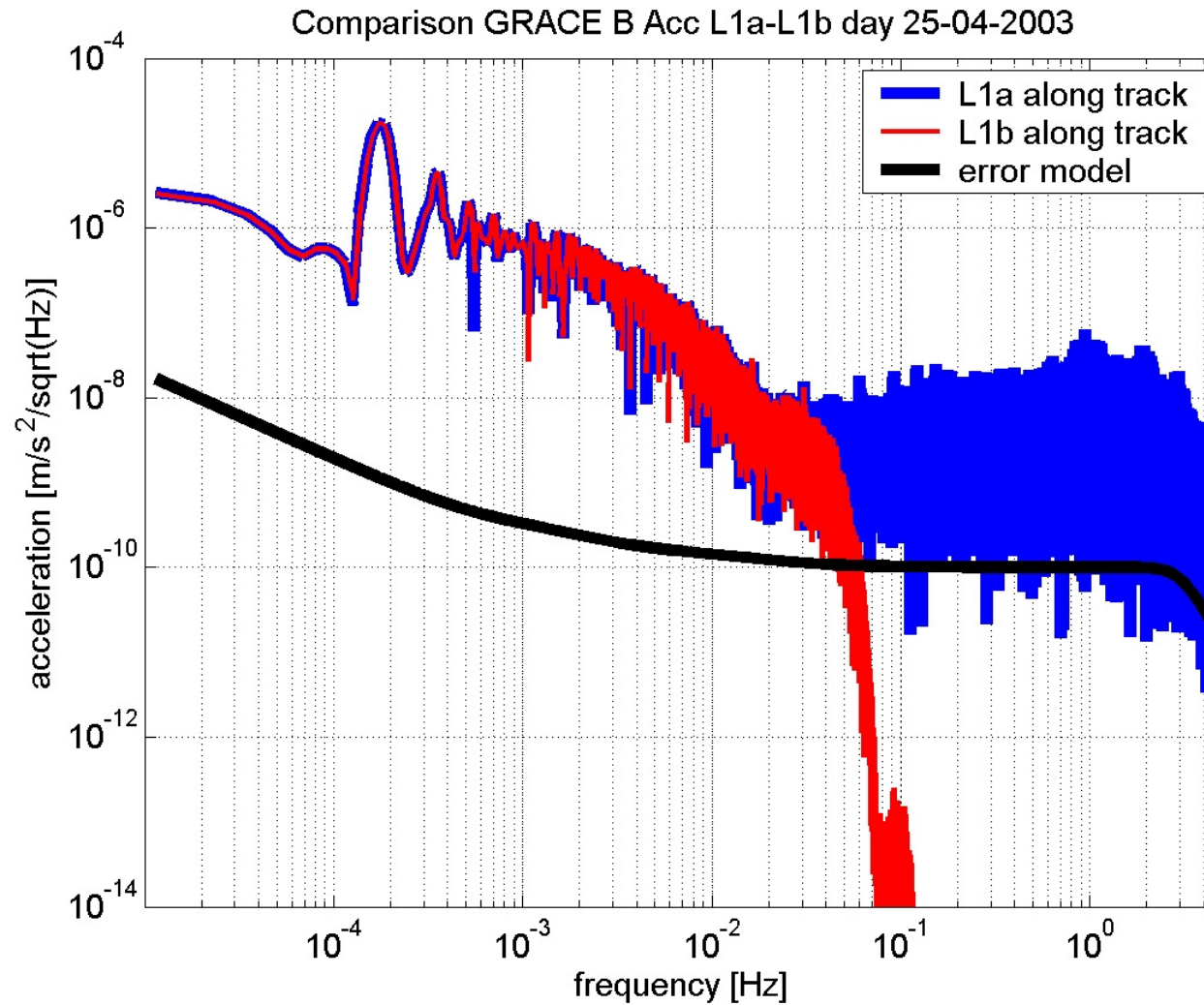



GRACE Combination of K-Band and Accelerometer

iapg

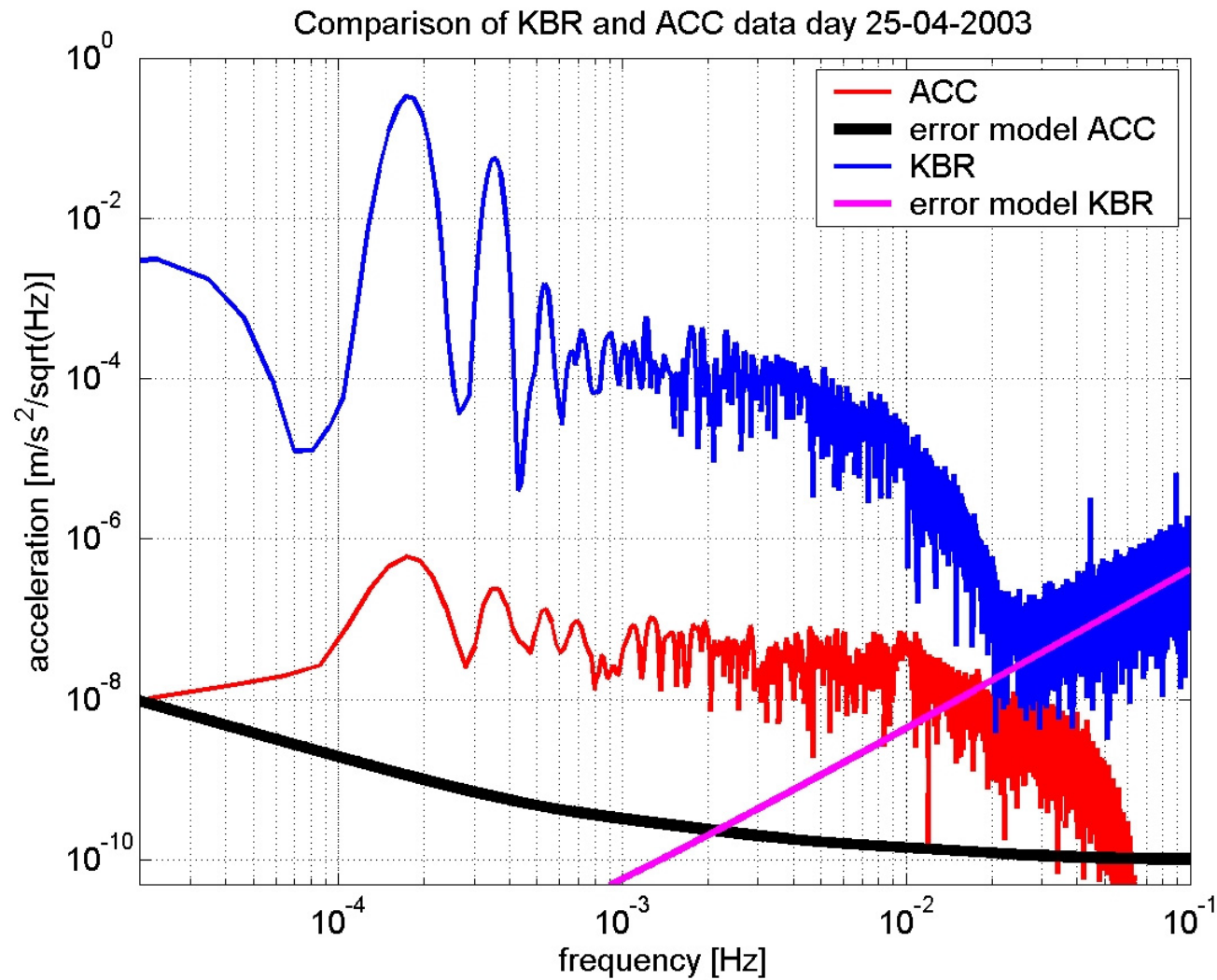

JPL



CSR



GFZ
POTSDAM

- **K-Band and SCA Performance agree with specifications**
- **Accelerometer noise level is to be determined**
- **At current orbit height K-Band accuracy limits Gravity Recovery accuracy**

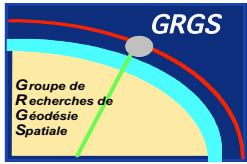

GRACE

Accelerometer data evaluation

G. Balmino & R. Biancale (GRGS)

Ch. Reigber & F. Flechtner (GFZ)

**Contribution to the derivation of
global Earth gravity field models
(both static and time variable)**

By direct processing of the GRACE observations

(GPS, laser ranging, accelerometers, plus ancillary data)

**+ Modeling of the Earth's upper atmosphere density
(thermosphere models)**

... as per the agreement of cooperation between GFZ and GRGS



In 2002-2003, at GRGS :
Implementation of the GRACE observation equations
in the OD and gravity model retrieval s/w (GINS)

Ambiguous range observation equation

Range-rate observation equation

} Based on J. Kim's PhD
dissertation (UTEX, 2000)

Acceleration observation equation : to be implemented later

Attitude (GRACE A and B quaternions)

GRACE SuperSTAR μ -Accelerometers :

- Update of the CHAMP-STAR data preprocessing s/w
- Comparison with physical models
- Comparisons SuperSTAR A vs SuperSTAR B

Tests with small data set recently provided



Preprocessing of the GRACE SuperSTAR μ -Accelerometer data

Attitude with respect to the RTN system

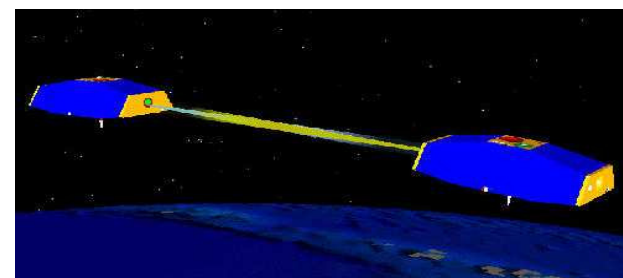

GRACE-A attitude according to nominal law (RTN)

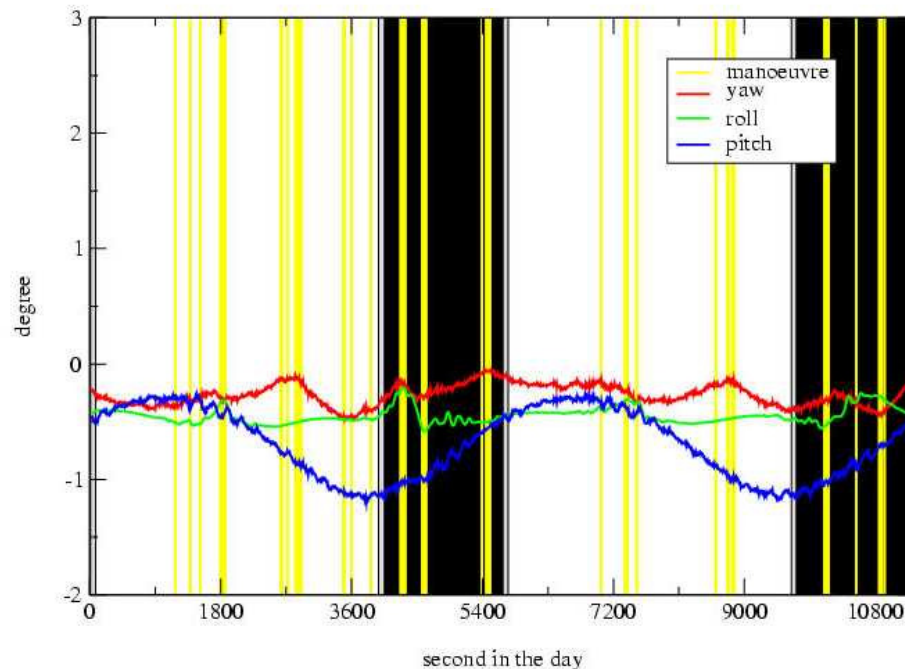

GRACE-B attitude according to nominal law (RTN)

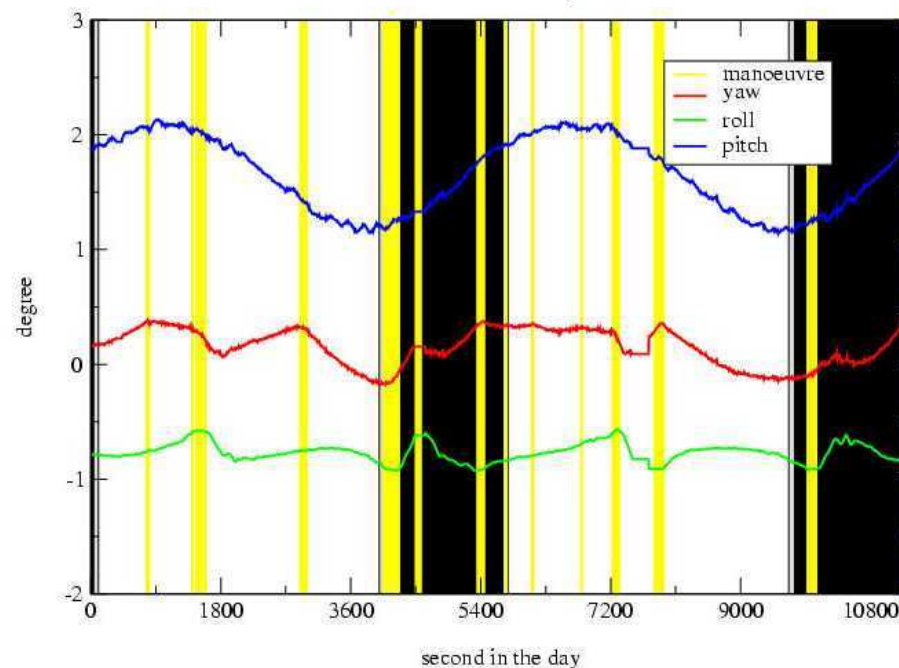

GINS attitude comparaison : GRACE-A, level A vs. level B

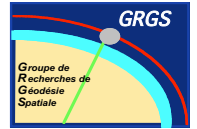

Pitch_(N)-(degree)_Rms:0.1986E+00

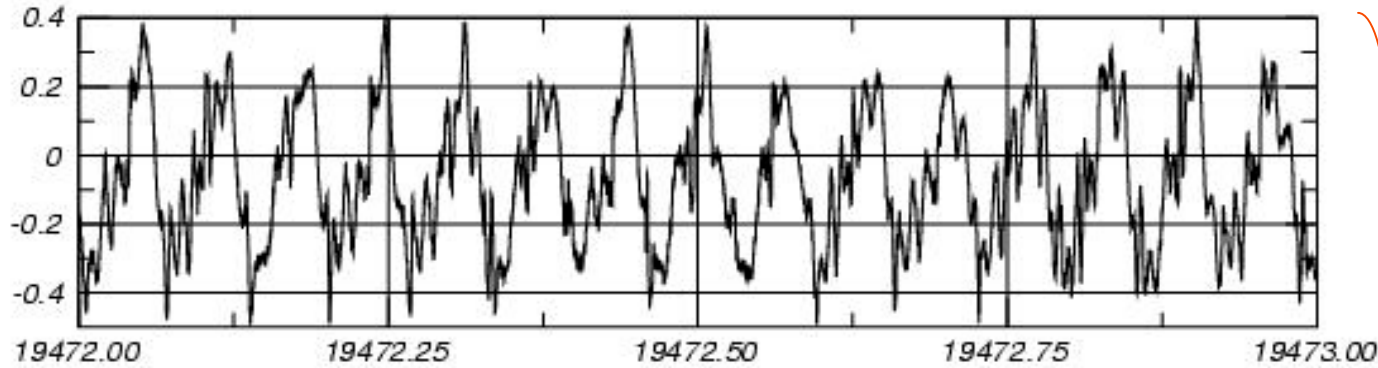

Roll_(T)-(degree)_Rms:0.2251E+00

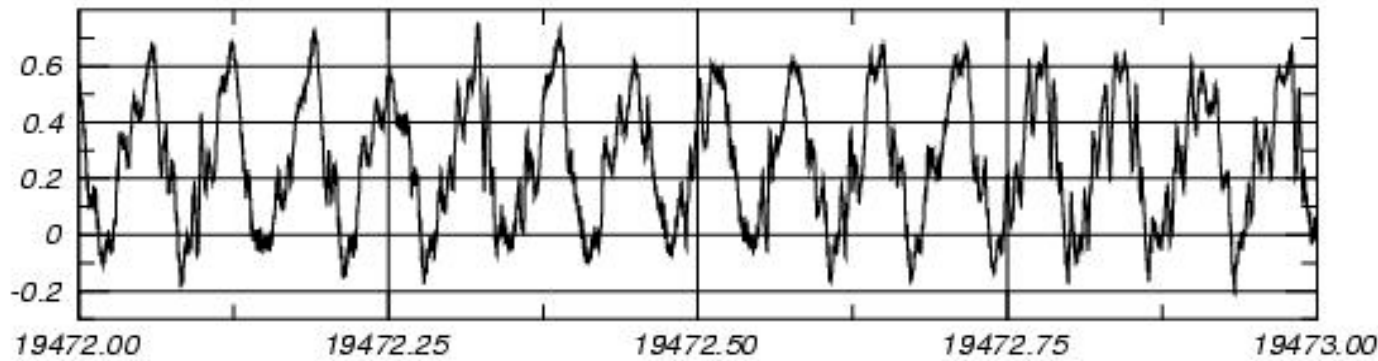

Yaw_(R)-(degree)_Rms:0.2792E+00

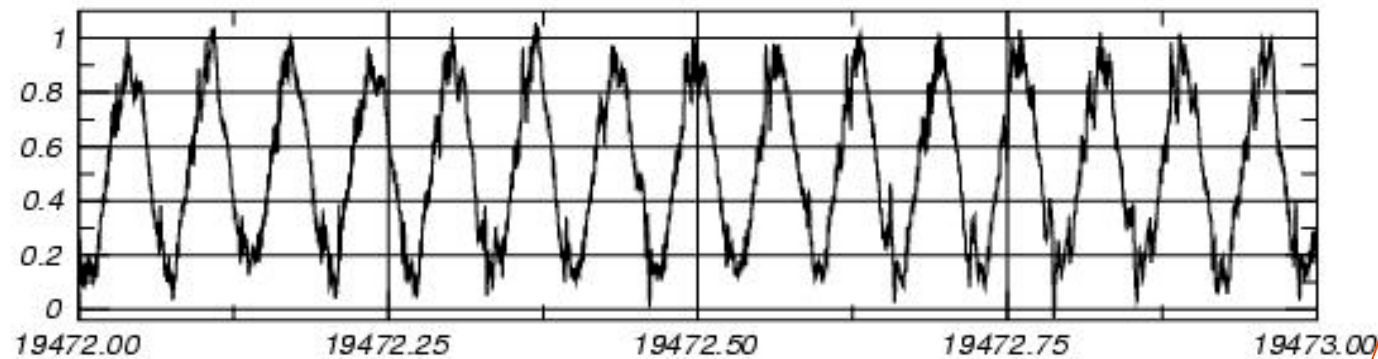

**Why
such differences
???**

*... but no significant
difference in
POD/KBR residuals
when taking the JPL
attitude correction*

0.1 sec. data



GRACE-A - Linear accelerations , April 25, 2003 (ve. 2.0)

mm/s²

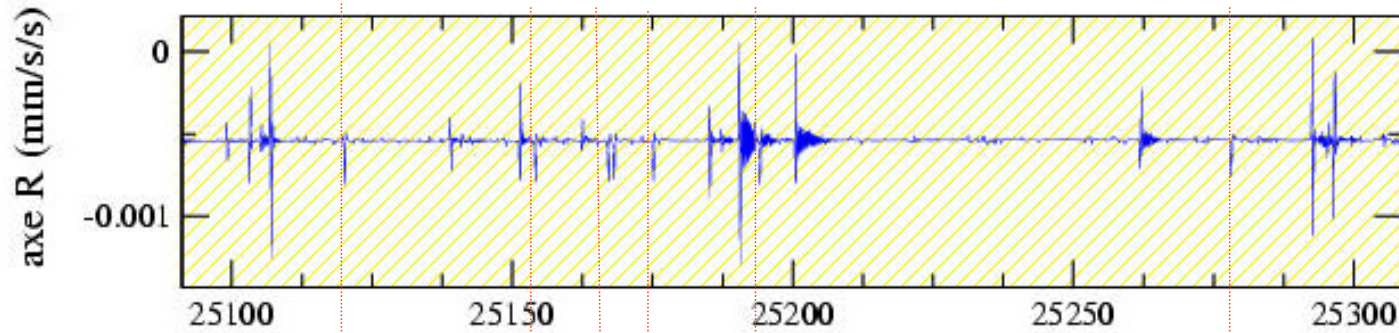

mean : -5.4 E-04
rms : 5.3 E-05

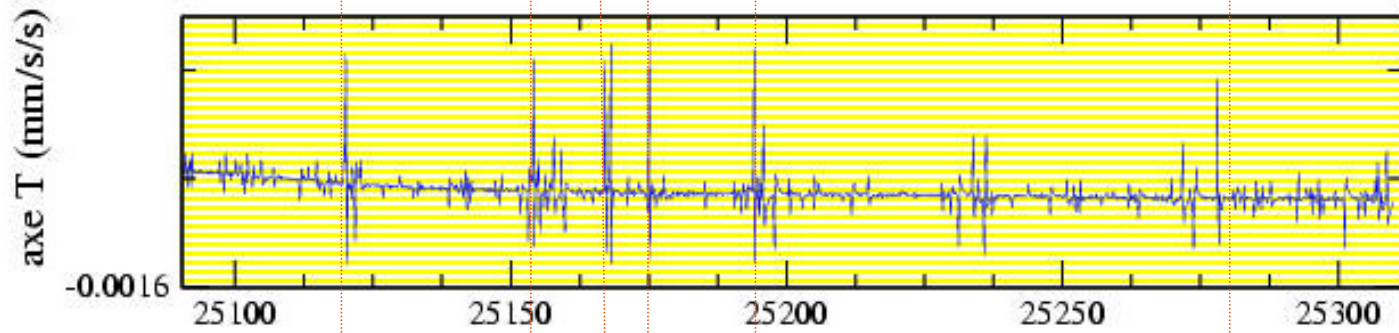

mean : -1.5 E-02
rms : 1.3 E-05

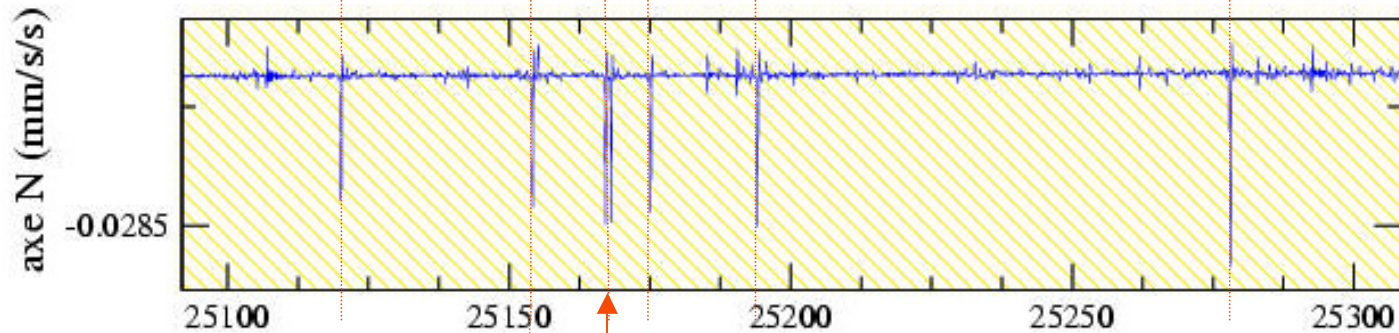

mean : -2.8 E-02
rms : 5.2 E-05

Time in seconds

manoeuvre (dated at xxx.7 sec)

1 sec. data (simple arithmetic mean of 0.1 sec measurements)



GRACE-A - Linear accelerations , April 25, 2003 (ve. 2.0) mm/s²

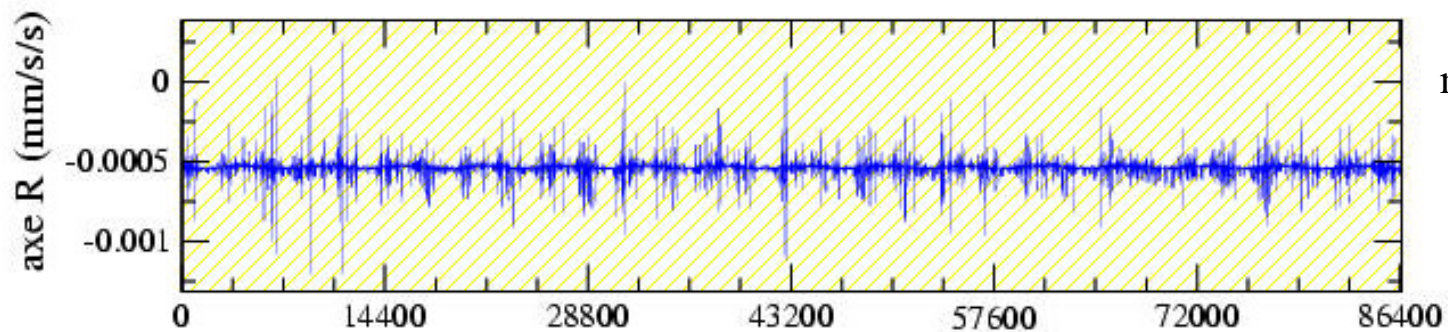

mean : $-5.4 \text{ E-}04$
rms : $2.1 \text{ E-}05$

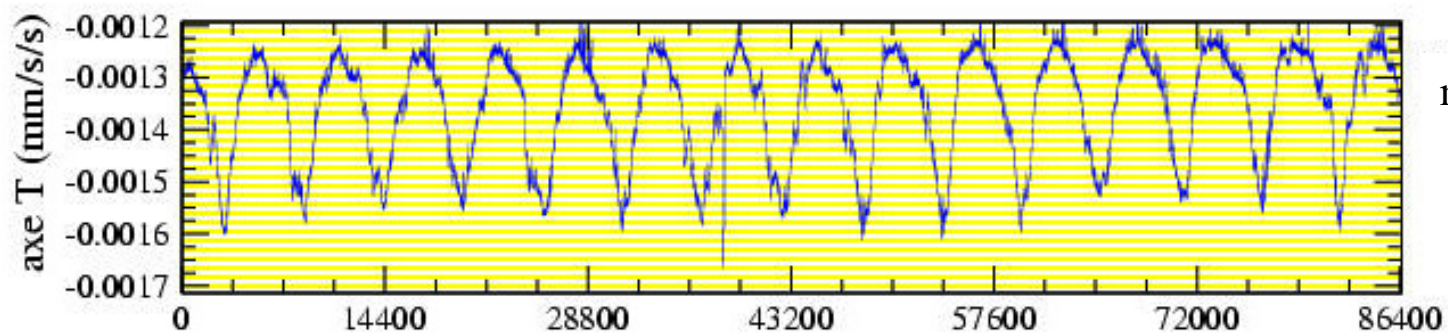

mean : $-1.4 \text{ E-}03$
rms : $1.0 \text{ E-}04$

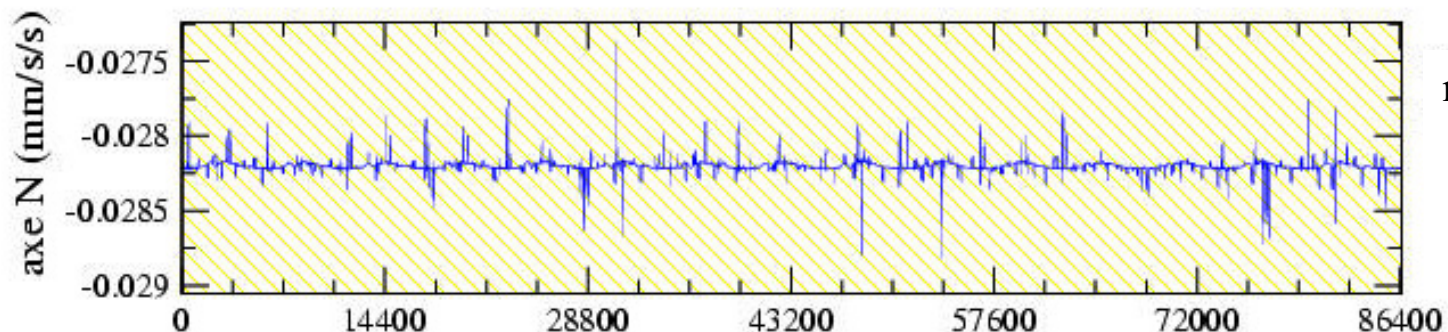

mean : $-2.8 \text{ E-}02$
rms : $6.1 \text{ E-}04$

Time in seconds

1 sec. data (simple arithmetic mean of 0.1 sec measurements)

GRACE-A - Angular accelerations , April 25, 2003 (ve. 2.0)

mrad/s²

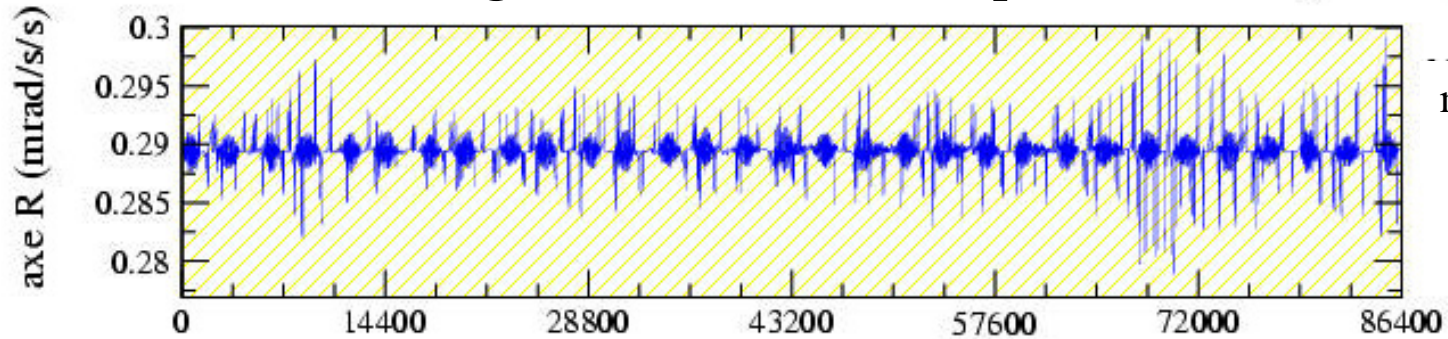

mean : +2.9 E-01
rms : 9.3 E-03

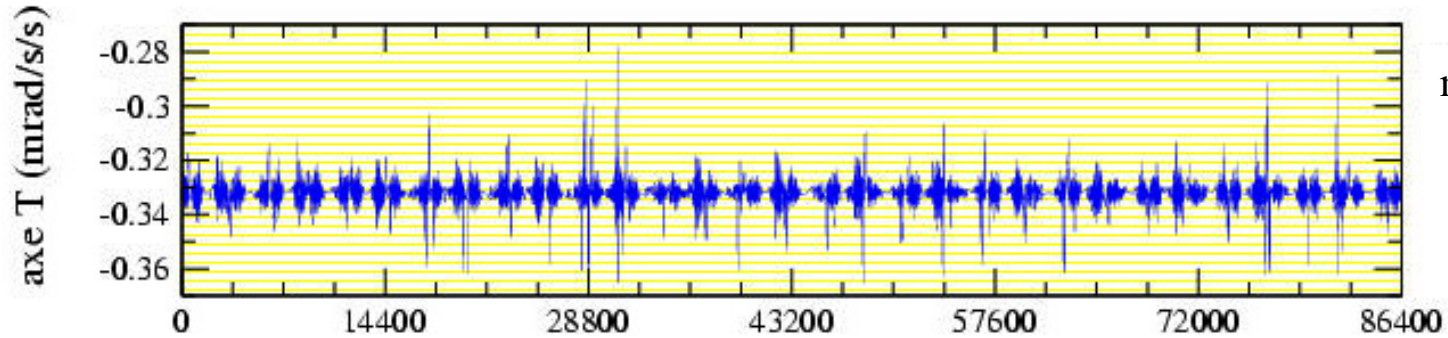

mean : -3.3 E-01
rms : 1.3 E-03

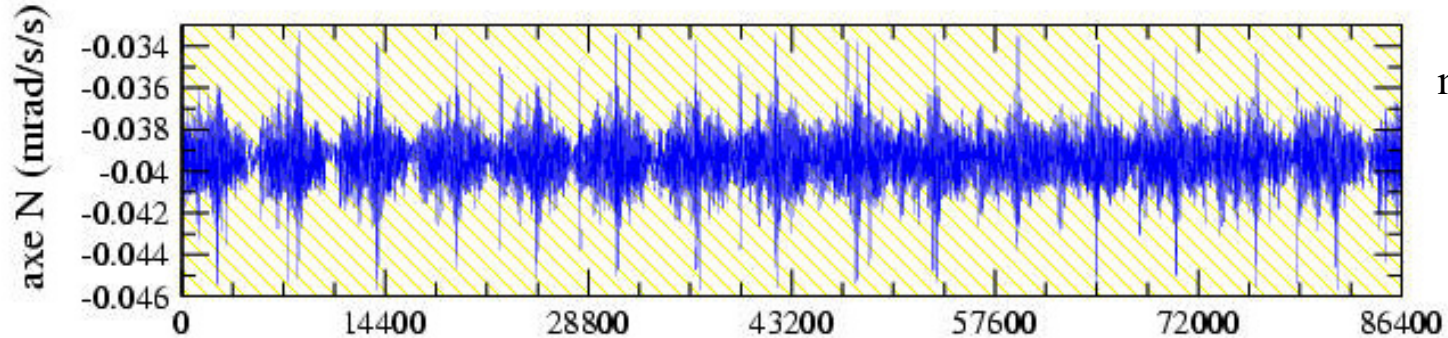

mean : -3.9 E-02
rms : 8.3 E-04

Time in seconds

⇒ Do we have an explanation for such pattern ?

Linear accelerations compared to models

Accelerations from Super-Star accelerometers compared to the sum of drag (DTM2000), solar pressure, Earth albedo and infra-red accelerations (ECMWF)

GRACE-A linear acceleration

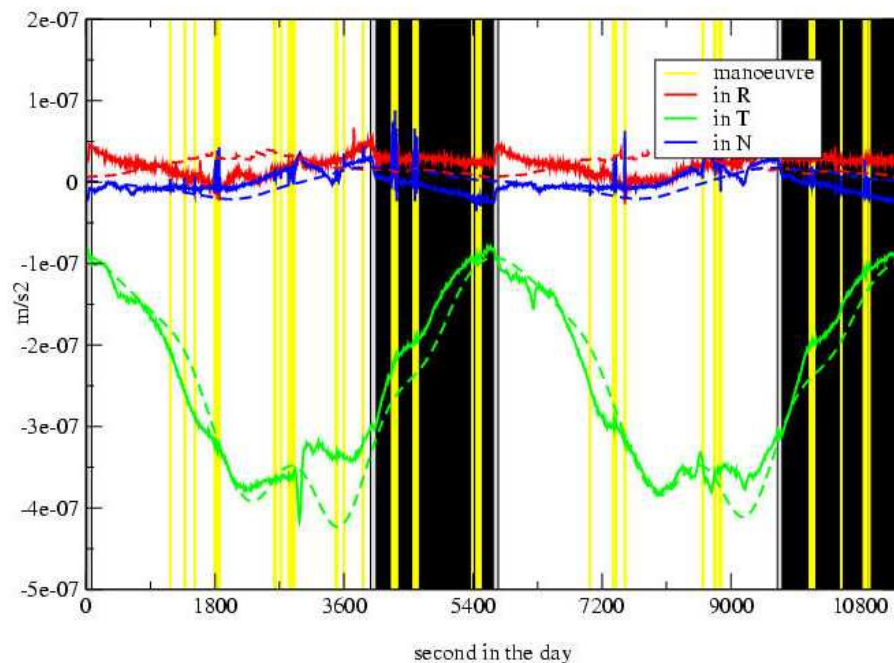

GRACE-B linear acceleration

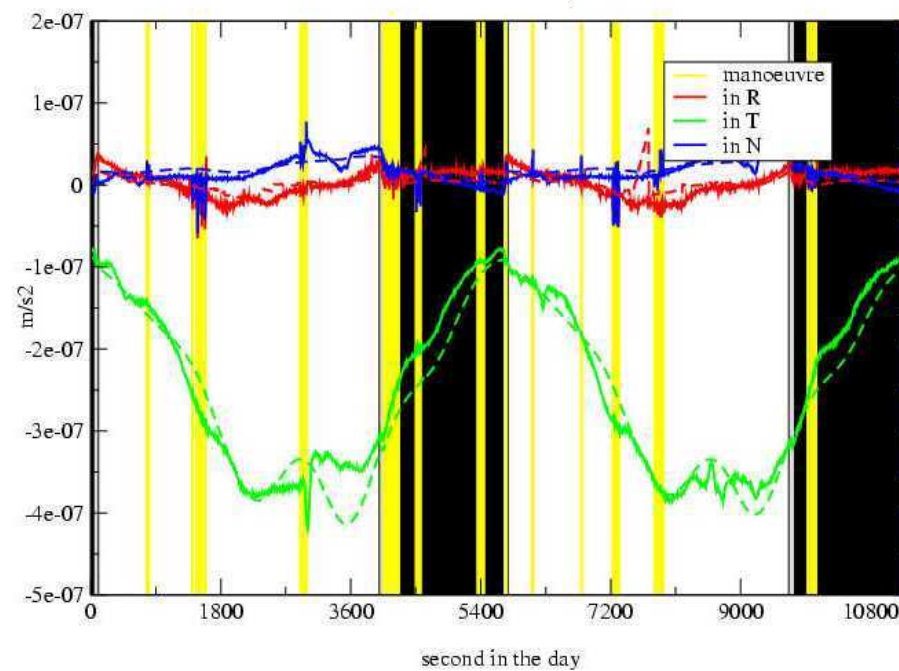

Editing & Smoothing

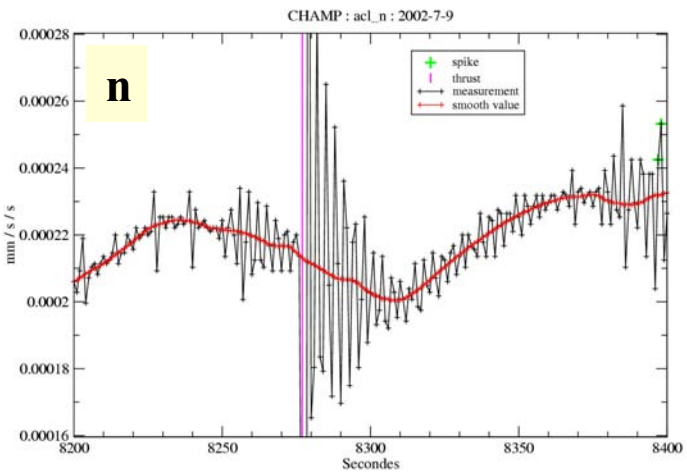
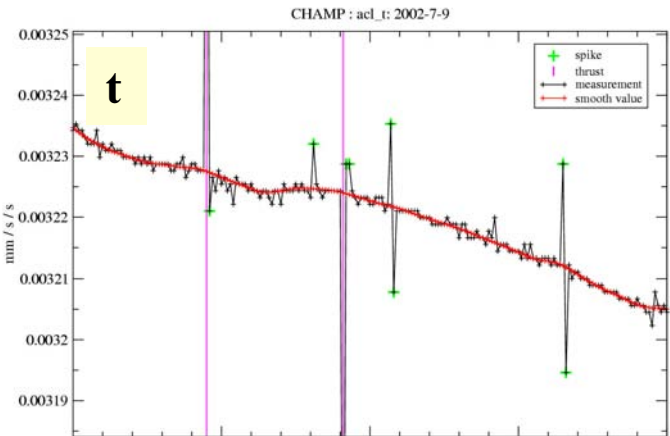
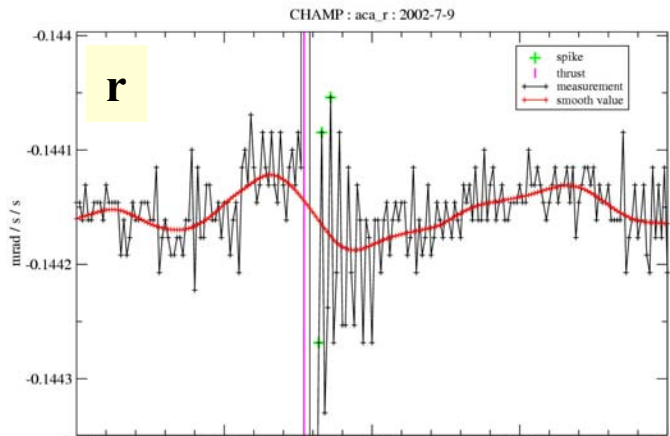

**C
H
A
M
P

S
T
A
R**

**G
R
A
C
E

S
u
p
e
r
-
S
T
A
R**

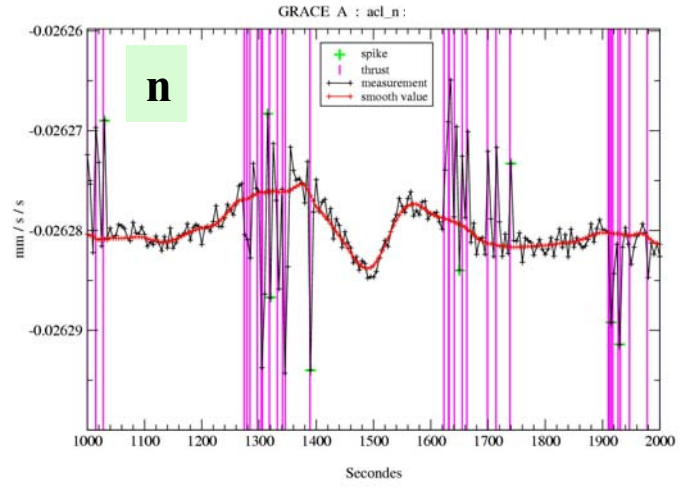
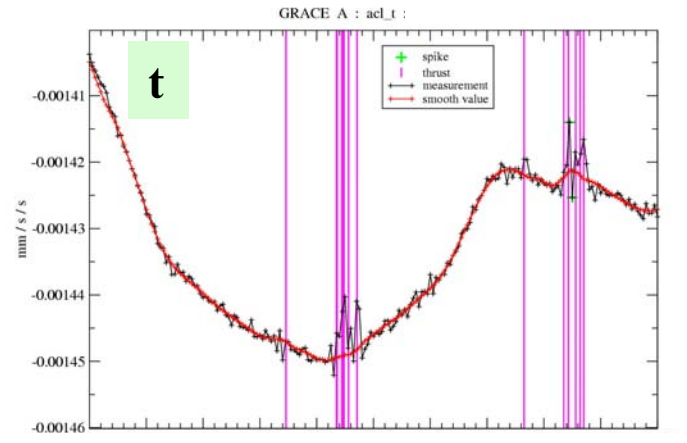
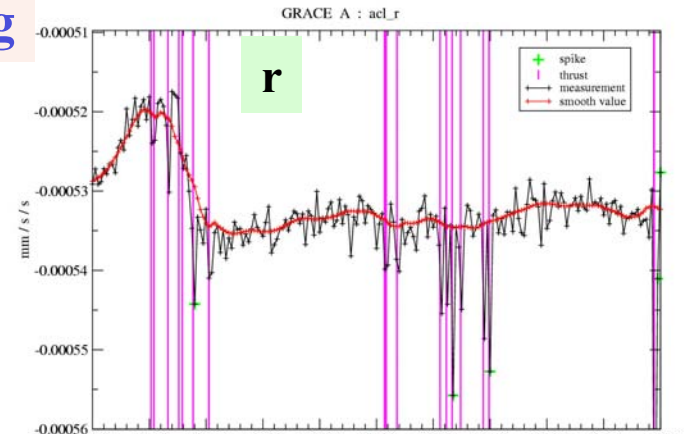

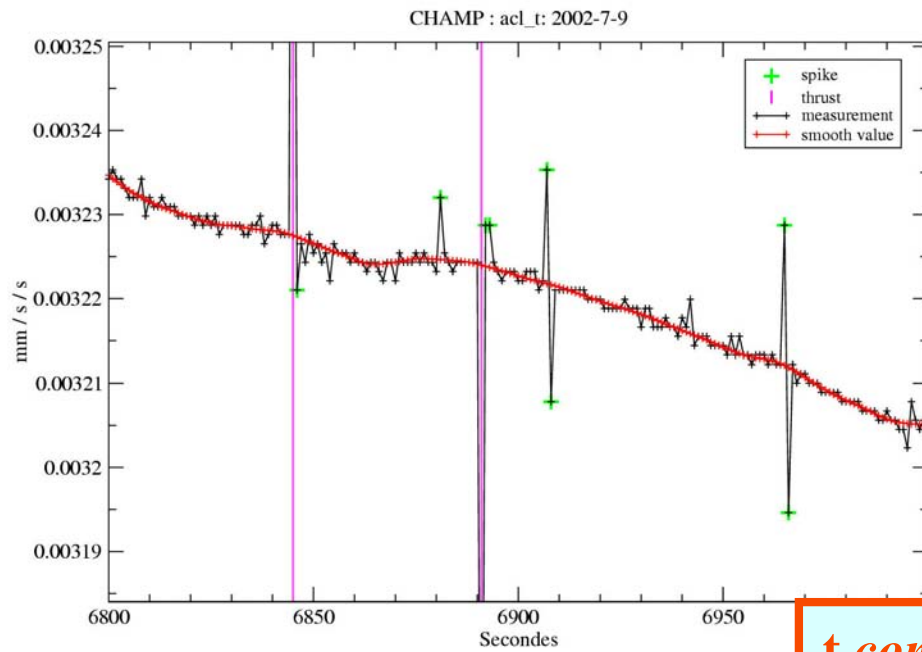

← CHAMP - STAR

t component

GRACE - Super STAR

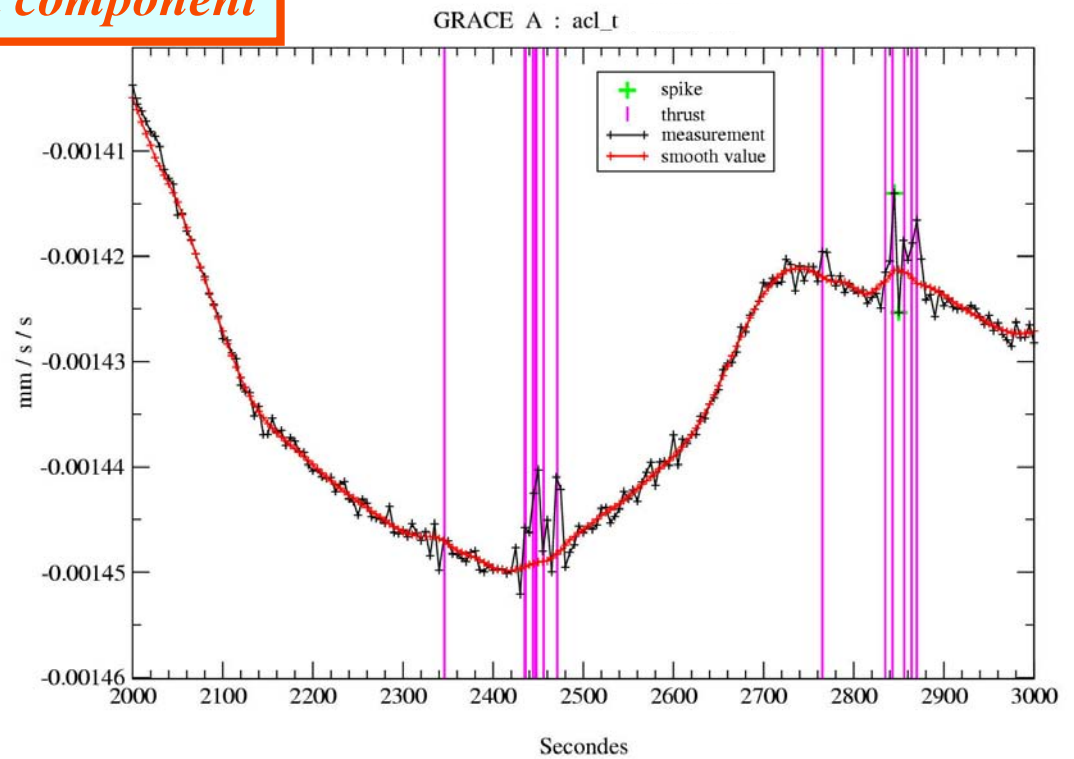
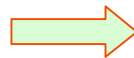

Smoothing and editing Super-STAR accelerometer data

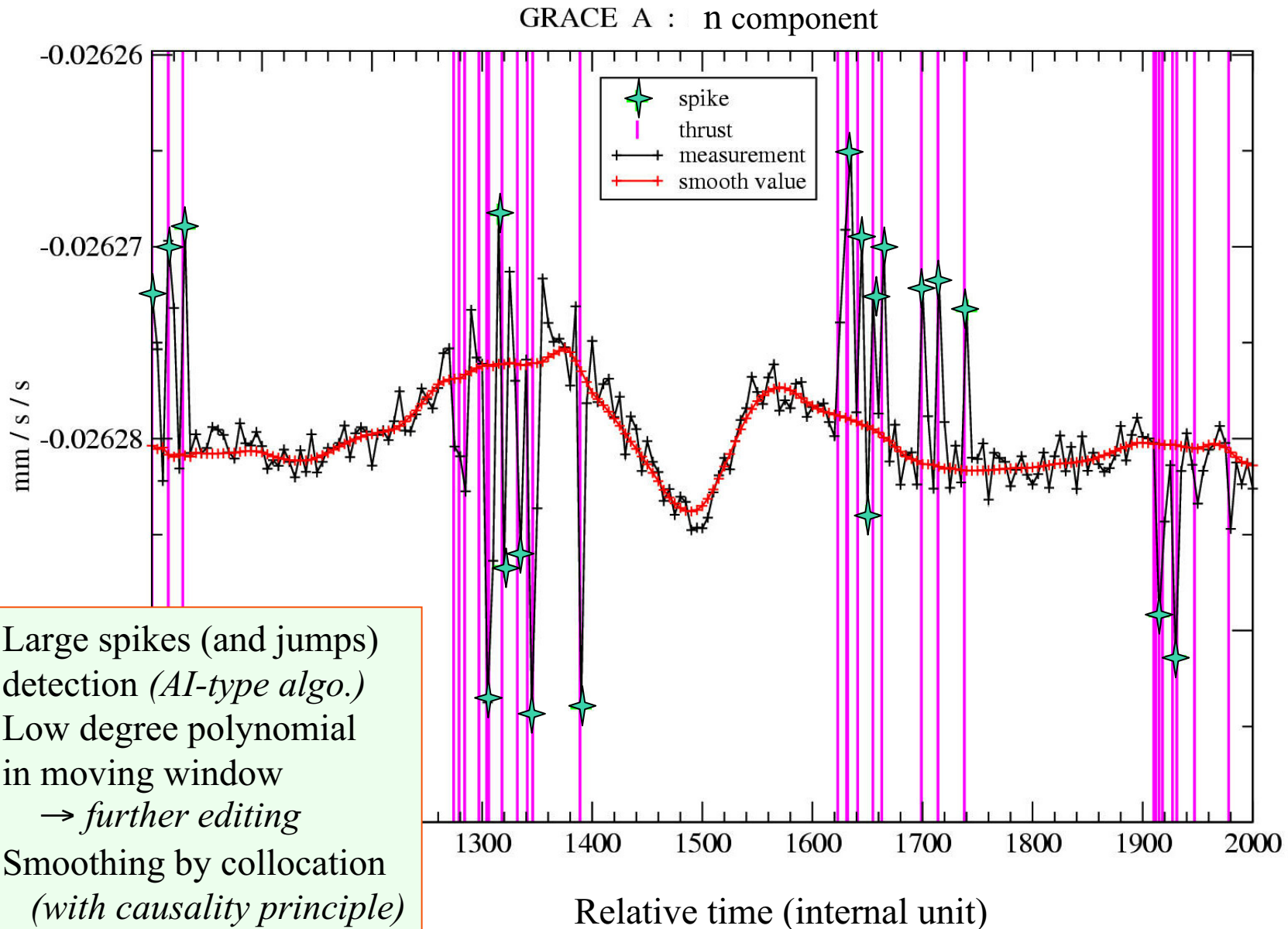

1 sec. data

Different ways of smoothing : GRGS-GFZ vs JPL

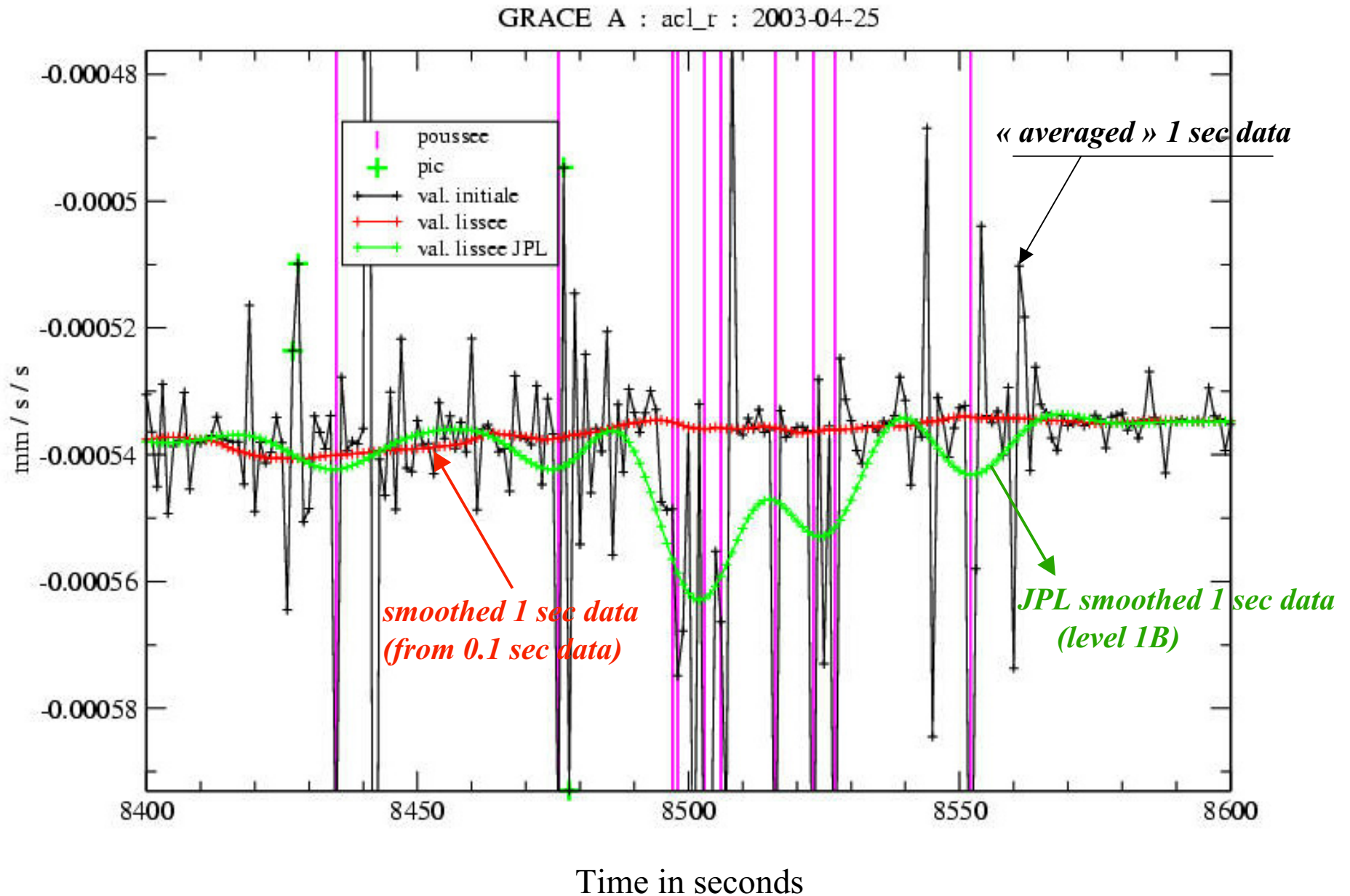

1 sec. data

Different ways of smoothing : GRGS-GFZ vs JPL

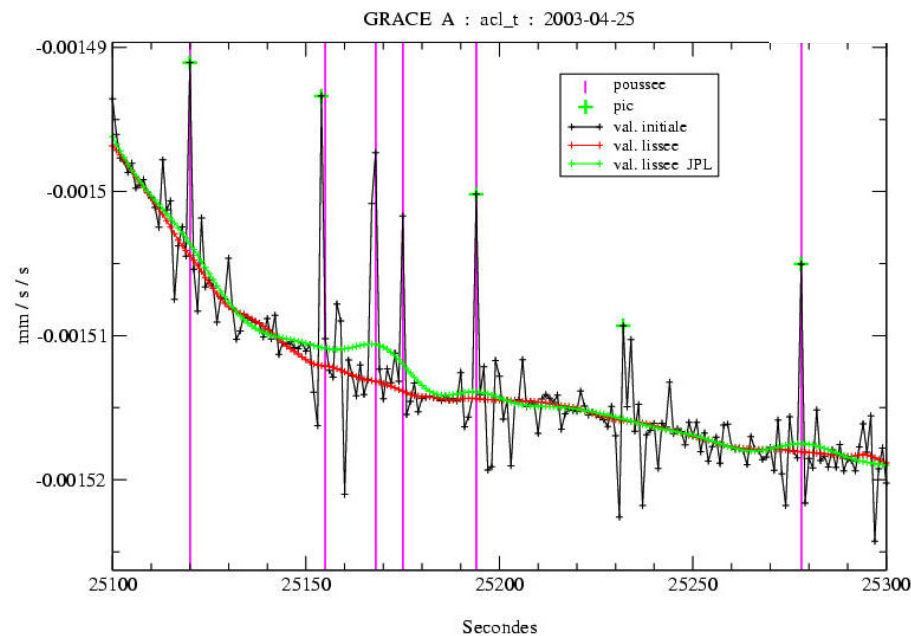
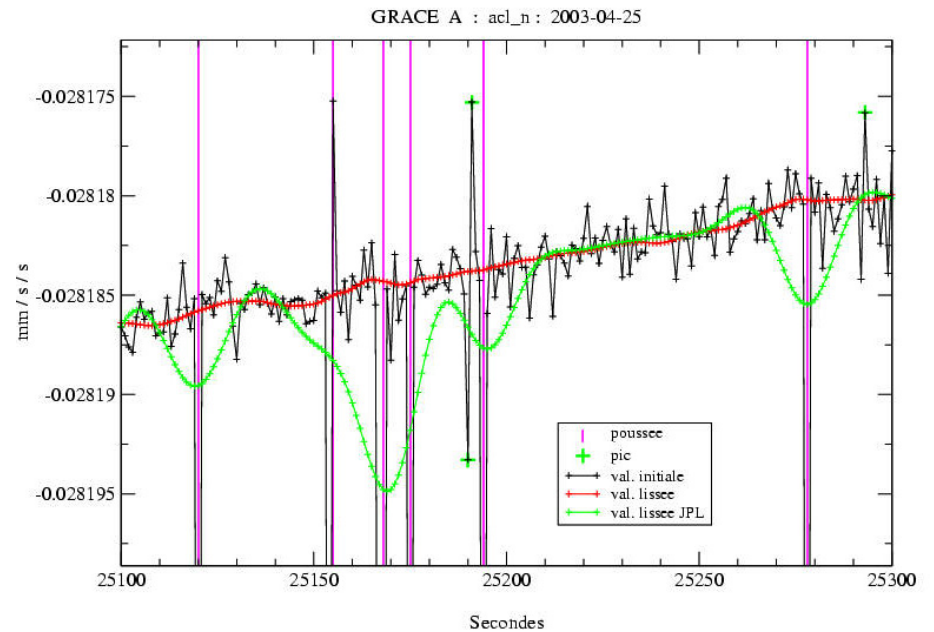
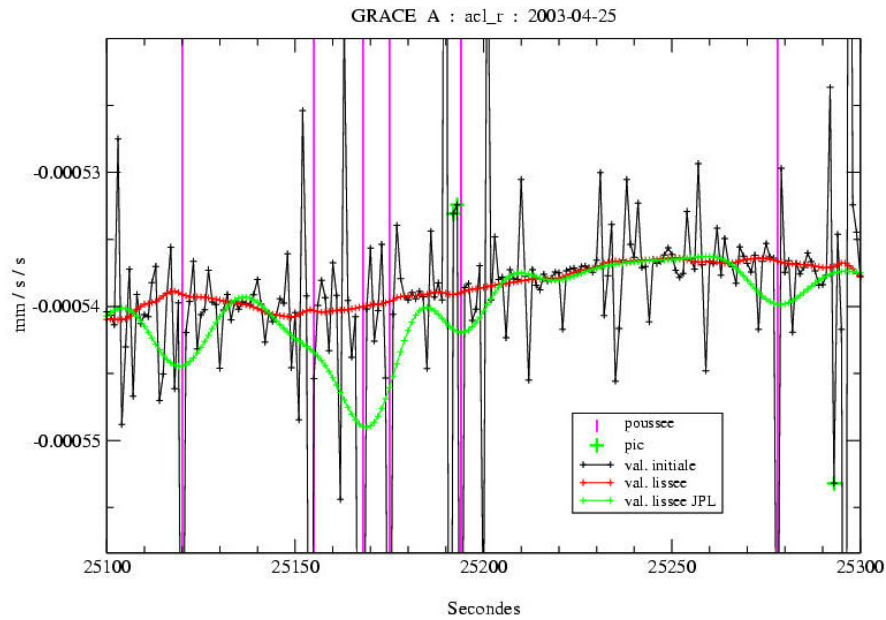
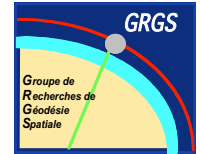

1. We keep for thermosphere modeling work
2. For POD and gravity modeling we add the integrated effect of the peaks following a manoeuvre (*at numerical integration node(s) after the manoeuvre*)

1 sec. data, one day (2003-04-25)

PSD

Spectrum of linear acceleration

— GRACE B
— GRACE A

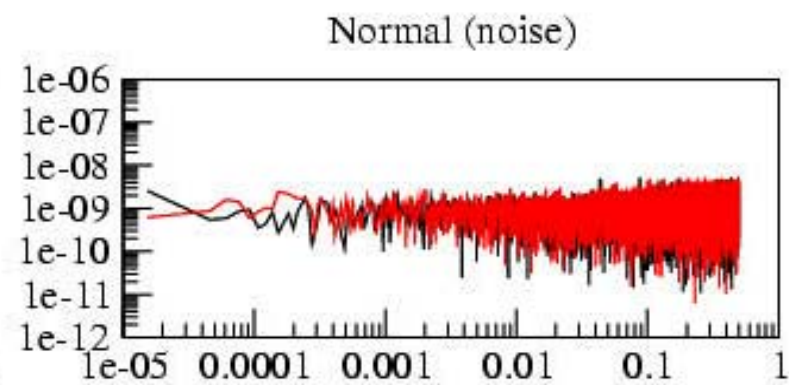
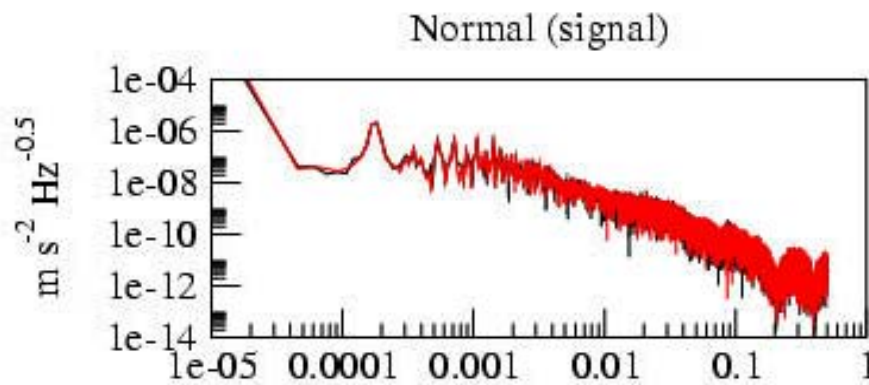
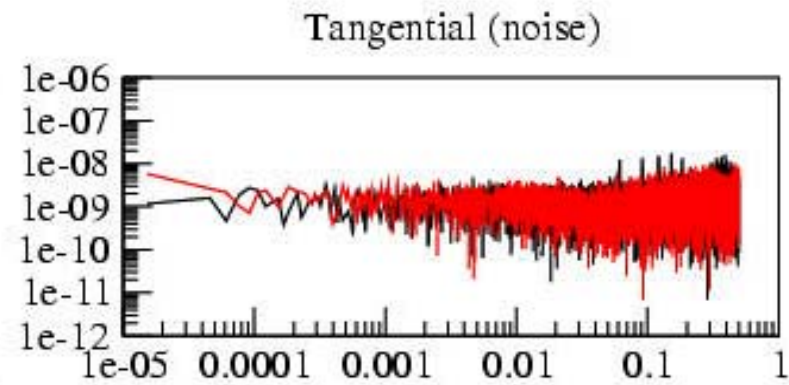
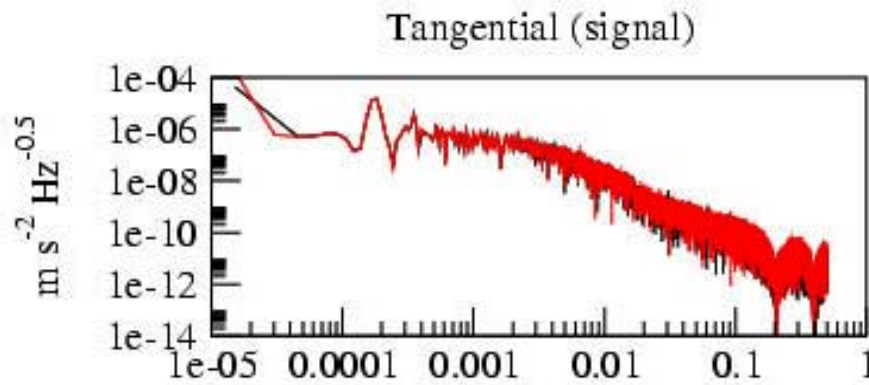
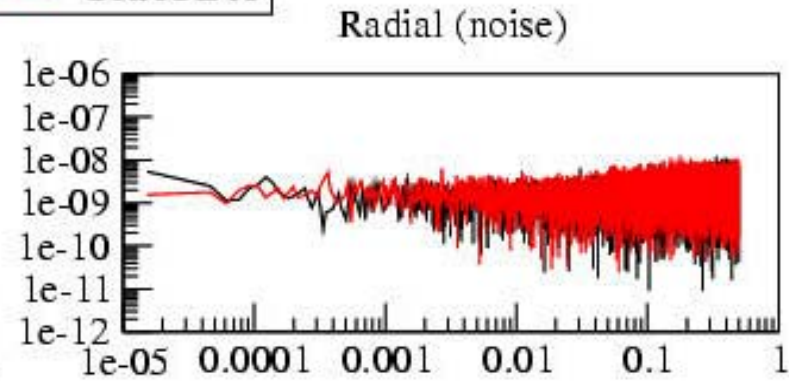
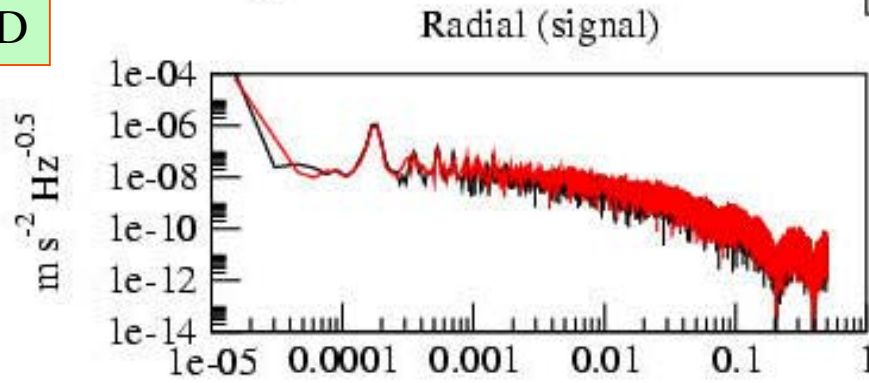

frequency (Hz)

frequency (Hz)

PSD

1 sec. data, one day (2003-04-25)

Spectrum of differences of linear acceleration (**GRACE-A vs. GRACE-B shifted by 24 sec**)

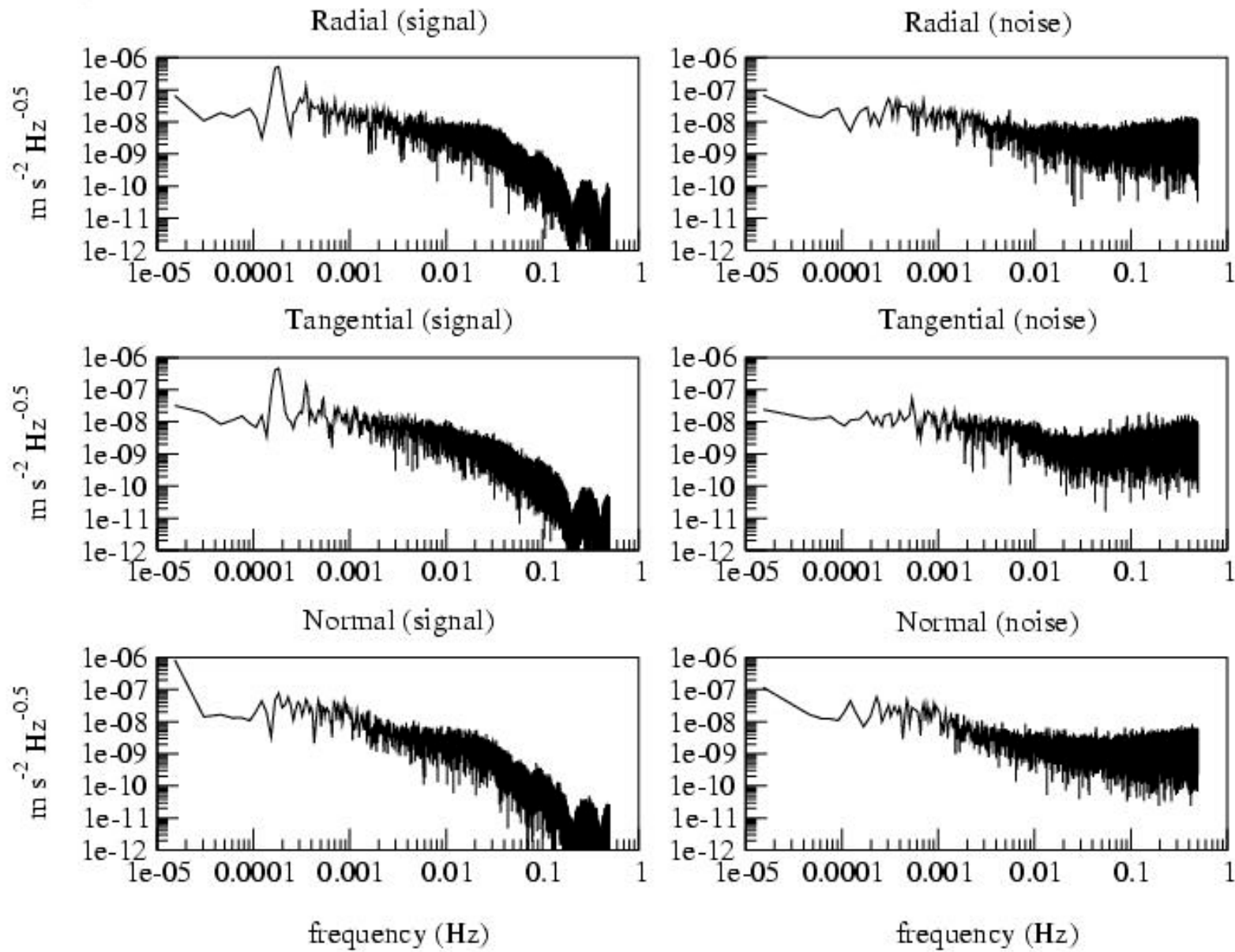

Comparison GRACE-CHAMP : 1 sec. data

— Grace B
— CHAMP
one day

PSD

Spectrum of linear acceleration

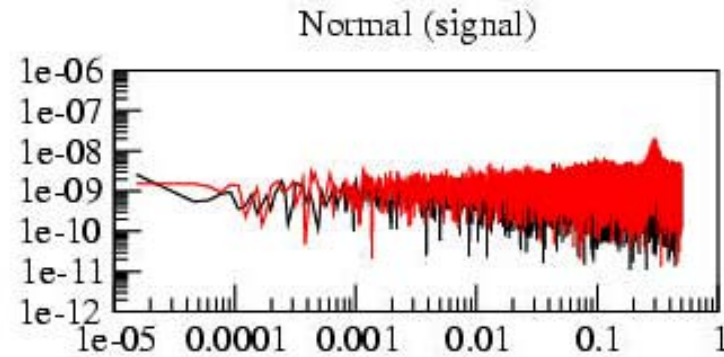
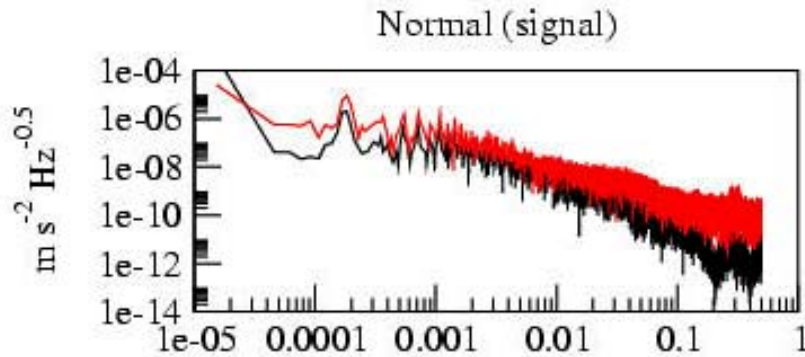
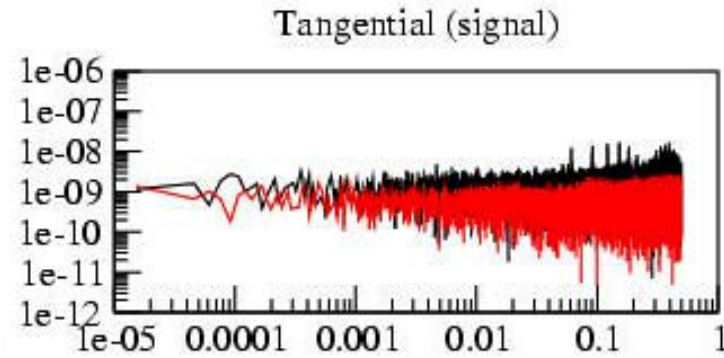
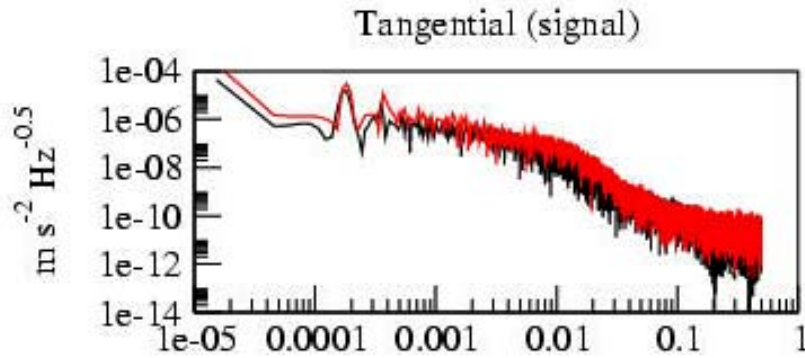
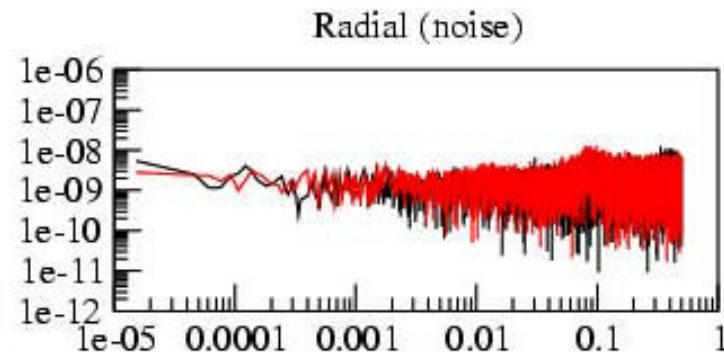
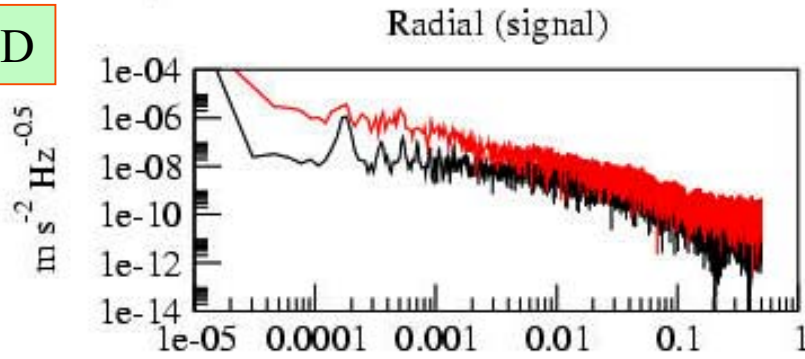

frequency (Hz)

frequency (Hz)

NEAR FUTURE ACTIVITIES

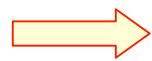
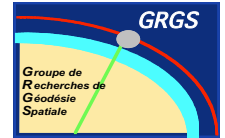

- Continue investigation on accelerometer noise level
Our results to-day show (too) large value

- Processing of GPS - GRACE A/B data
... in DD formulation (*at GRGS*)

- Implementation of relative acceleration observation equation

- Augmented (empirical) parameterization of the KBR observation equations (*pb. of measurement bandwidth*)

- Further comparisons between GFZ and GRGS s/w

- Continue processing Laser satellite data (*long λ of models*)

- Use of μ -Accel. data (CHAMP + GRACE)
for thermosphere models

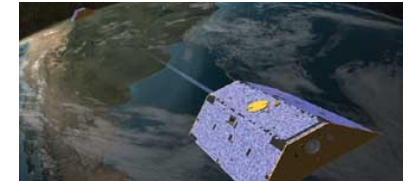

Unique approaches to addressing time variable gravity from GRACE

PI: F. G. Lemoine, (NASA/GSFC)

Co-I's: D. D. Rowlands, R. D. Ray, S. B. Luthcke (NASA/GSFC)

S. M. Klosko, C. M. Cox (RITSS)

OBJECTIVE:

(1) Short-arc analysis of intersatellite tracking for gravity recovery [*Rowlands et al.*, 2002].

(2) Recovery of temporal variations in the geopotential through estimation of surface anomaly blocks [*Kahn et al.*, 1982].

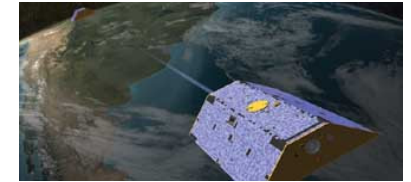

Unique approaches to addressing time variable gravity from GRACE (2)

Short-arc analysis summary [*Rowlands et al.*, 2002]

1. Gravity information can be recovered in arcs as short as 15 minutes.
2. Intersatellite measurements can be decoupled from the GPS measurements.
3. Facilitates analysis on a regional basis.
- 4A. It is useful to reformulate the initial state of the two satellites into parameters describing the midpoint of the satellite system, and the baseline between the two satellites.
- 4B. If one starts with an accurate orbit (e.g. reduced-dynamic based on GPS) only a few of these epoch parameters need to be adjusted.

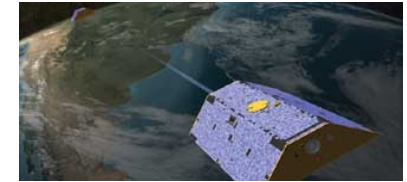

Formal errors from GRACE gravity simulations employing short arcs (a), and long arcs (b).

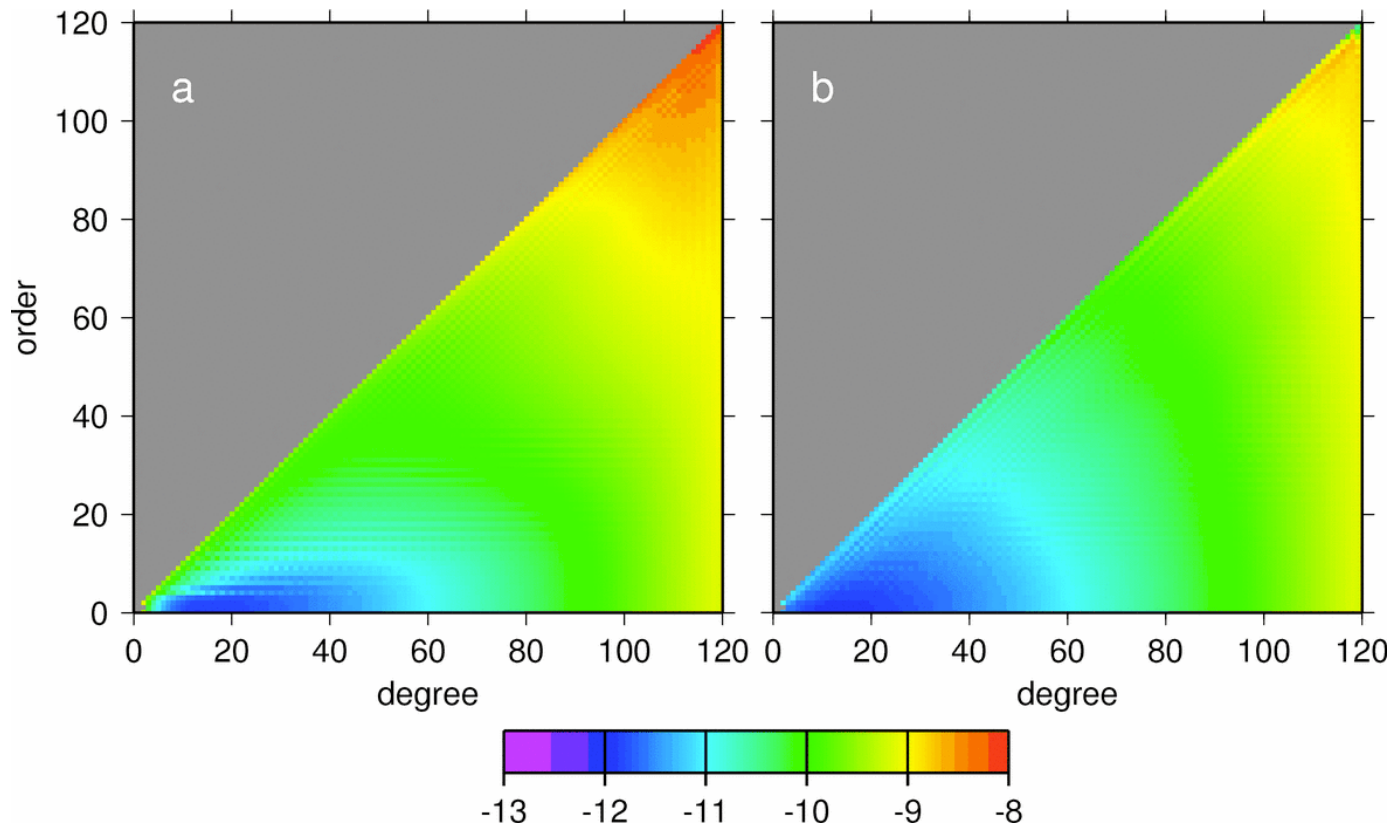

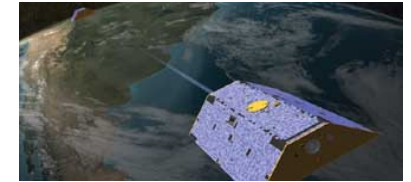

Results of 1-week validation study

- 1. Precise orbits (Product GPS1B) are good.**
Can be used to reduce range data with only minor adjustments.
- 2. Accelerometry appears good at long wavelengths.**
Some questions about filtering of thrusting events.
- 3. GGM01C gravity model greatly reduces fits to intersatellite range data relative to pre-GRACE gravity models.**
- 4. Noise in 5-sec range satellite ranging data is $\sim 1 \mu\text{m}$.**
- 5. Noise in range-rate data (5-sec counting interval) $\sim 0.3 \mu\text{m/s}$.**
What is noise in 1-Hz data?
- 6. Documentation is easy to use.**



Geometric Accelerometry
Analysis (X in SRF)

GRACE A

GRACE A Macro-model

Orbit held fixed to precise orbit

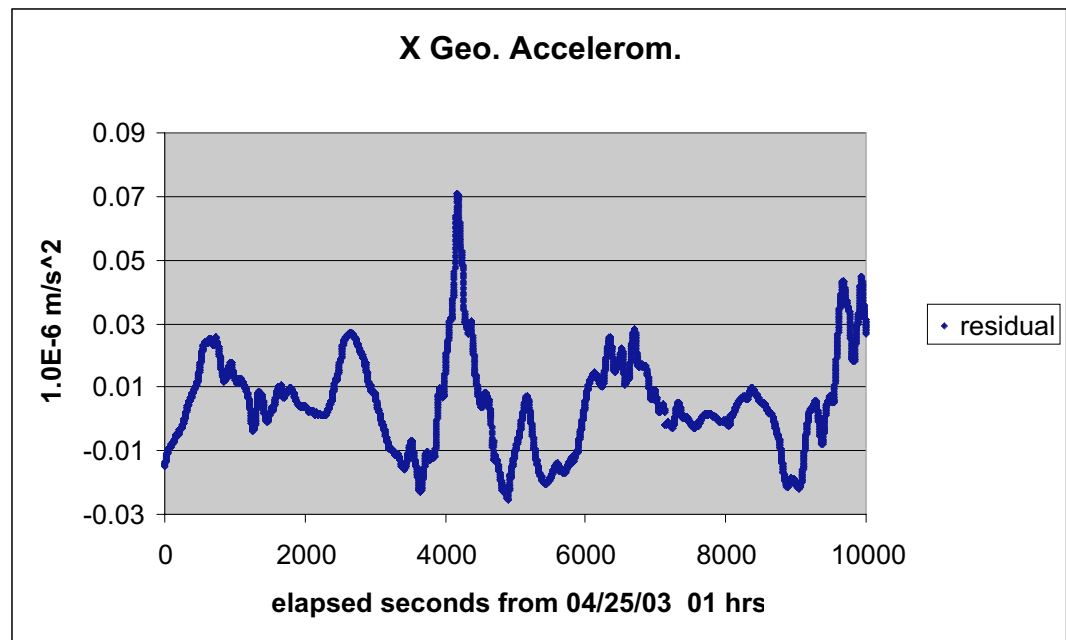
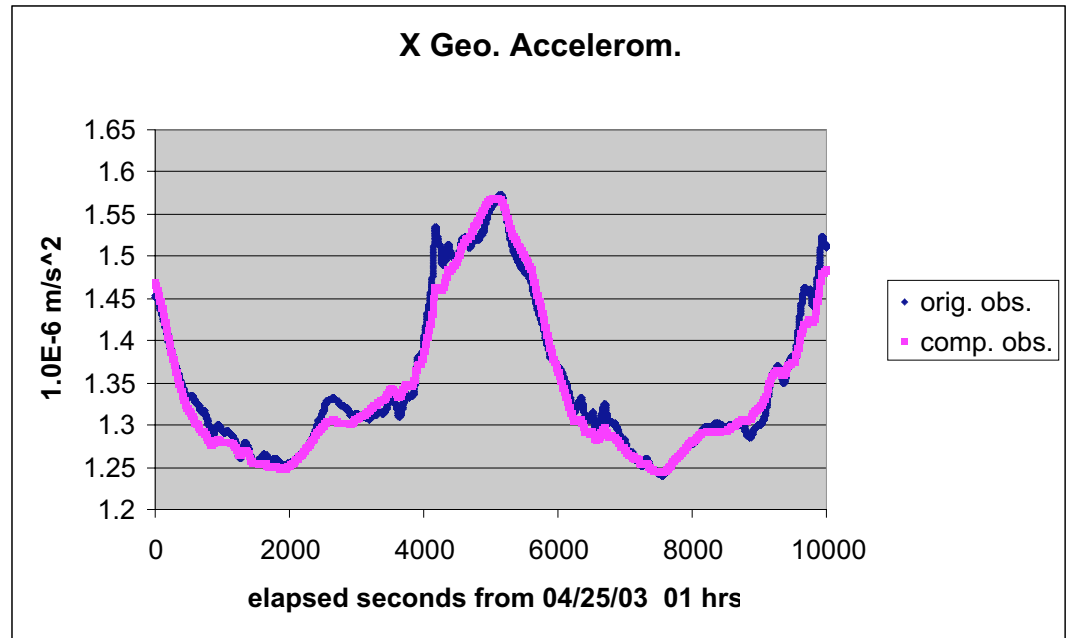



X-Accelerom. Resid Diff. (GraceA resid - GraceB resid)

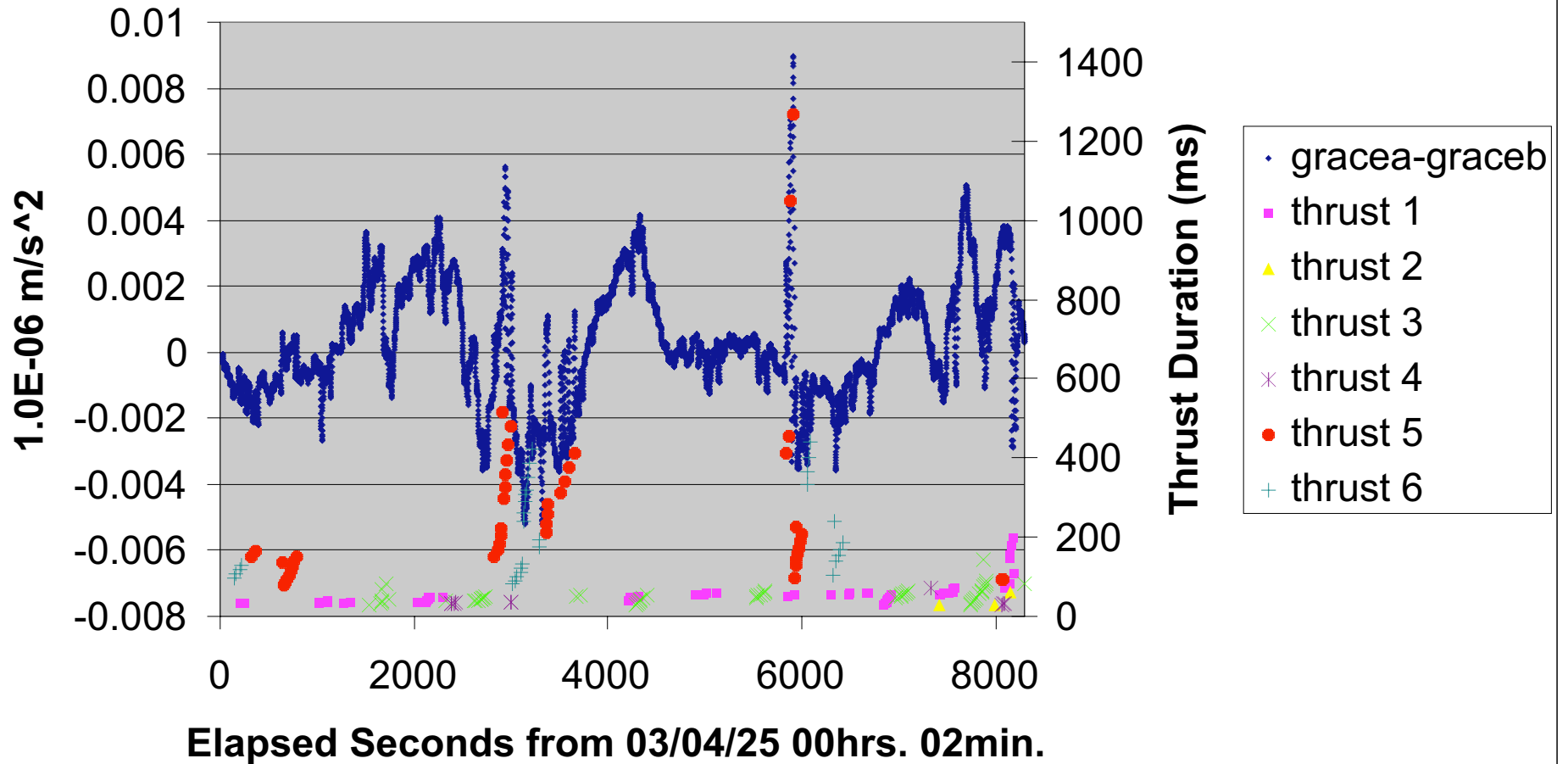

GRACE Geoid & GPS Leveling

J. Huang and M. Véronneau

(presented by Ch.Reigber/GFZ)

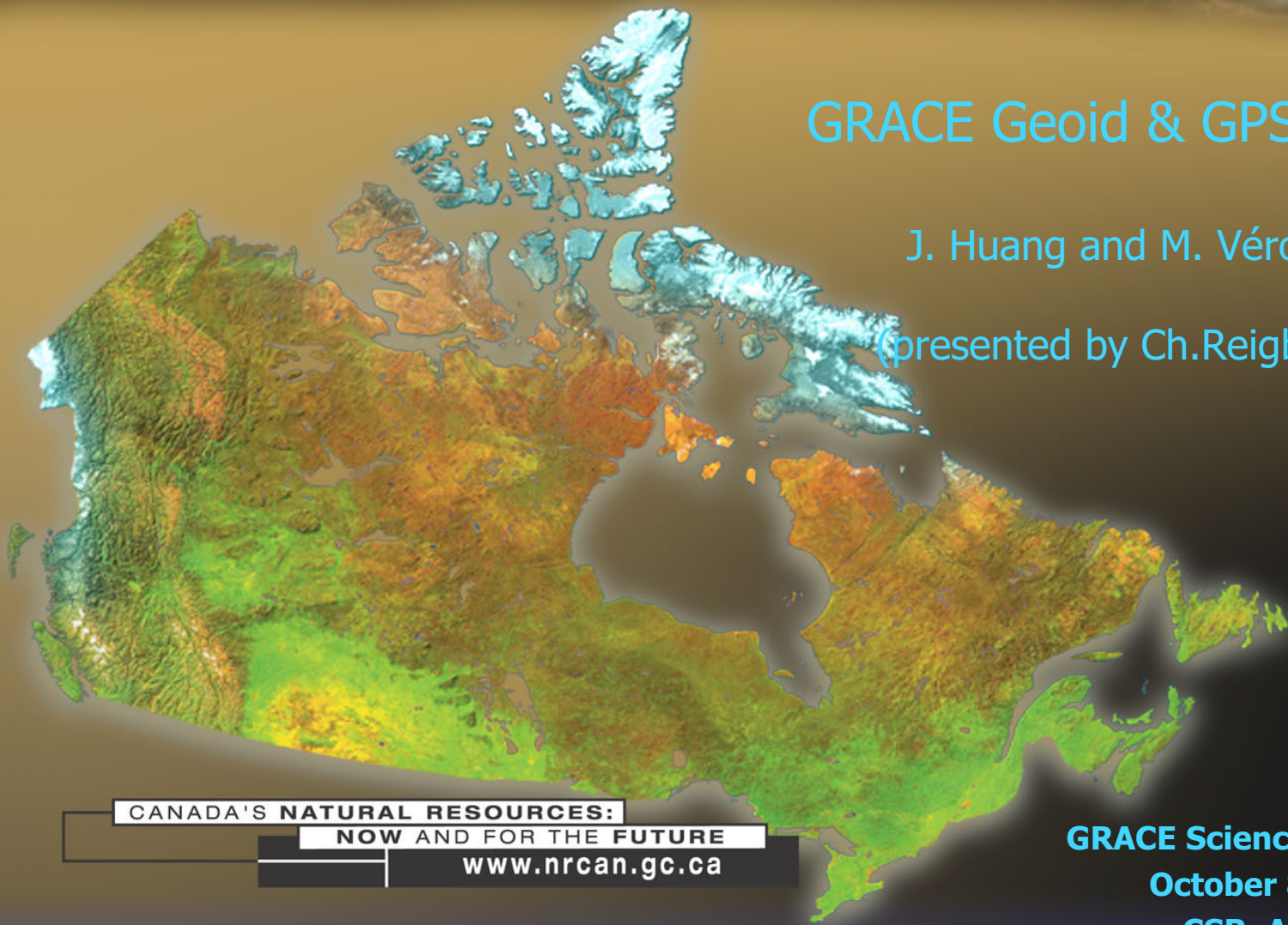

CANADA'S NATURAL RESOURCES:
NOW AND FOR THE FUTURE
www.nrcan.gc.ca

GRACE Science Team Meeting
October 8-10, 2003
CSR, Austin, TX



Natural Resources
Canada

Ressources naturelles
Canada

Canada

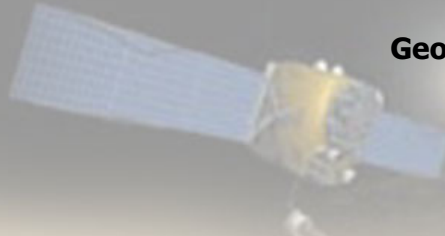

Outlines

- The degree-banded Stokes-Helmert technique
- Validation of GRACE models by GPS-Leveling in Canada
- Preliminary calibration of GRACE models by GPS-Leveling in Canada
- Future plan



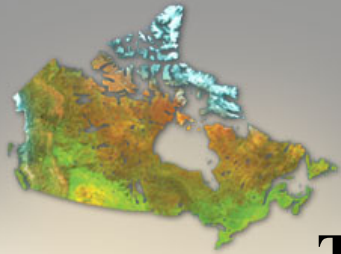

The degree-banded Stokes-Helmert technique

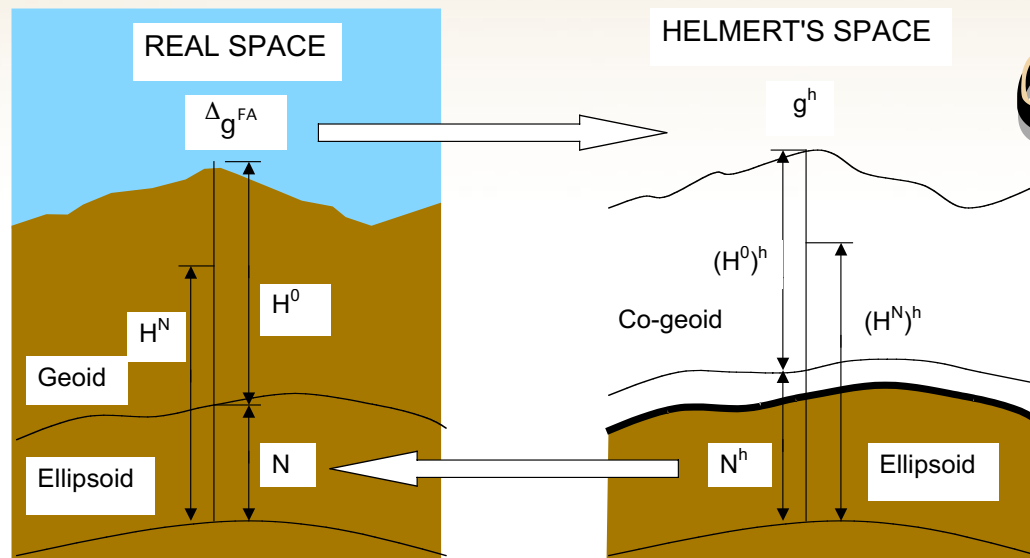

This technique combines a satellite gravity (SG) solution with terrestrial gravity data for determination of the geoid, i.e., the satellite solution defines the low-degree geoid components while the terrestrial data give details of the geoid.

$$N^h = N_{h,2\sim l}^{SG} + N_{h,l+1\sim m_{SG}}^{SG} + \frac{R}{4\pi\gamma} \int_{\Omega_0'} S_{DB}(\psi) (\Delta g^h - \Delta g_{h,2\sim l}^{SG} - \Delta g_{h,l+1\sim m_{SG}}^{SG}) d\Omega' + c_e$$

A high-pass operator to the geoid components

$$S_{DB}(\psi) = \sum_{n=l+1}^{m_{TG}} \frac{2n+1}{n-1} P_n(\cos\psi) \quad \longrightarrow \quad N = N^h + PITE$$

The degree-banded Stokes kernel

The primary indirect topographic effect.



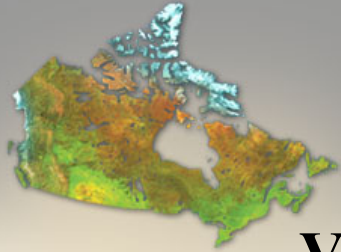

Validation of GRACE models by GPS-Leveling

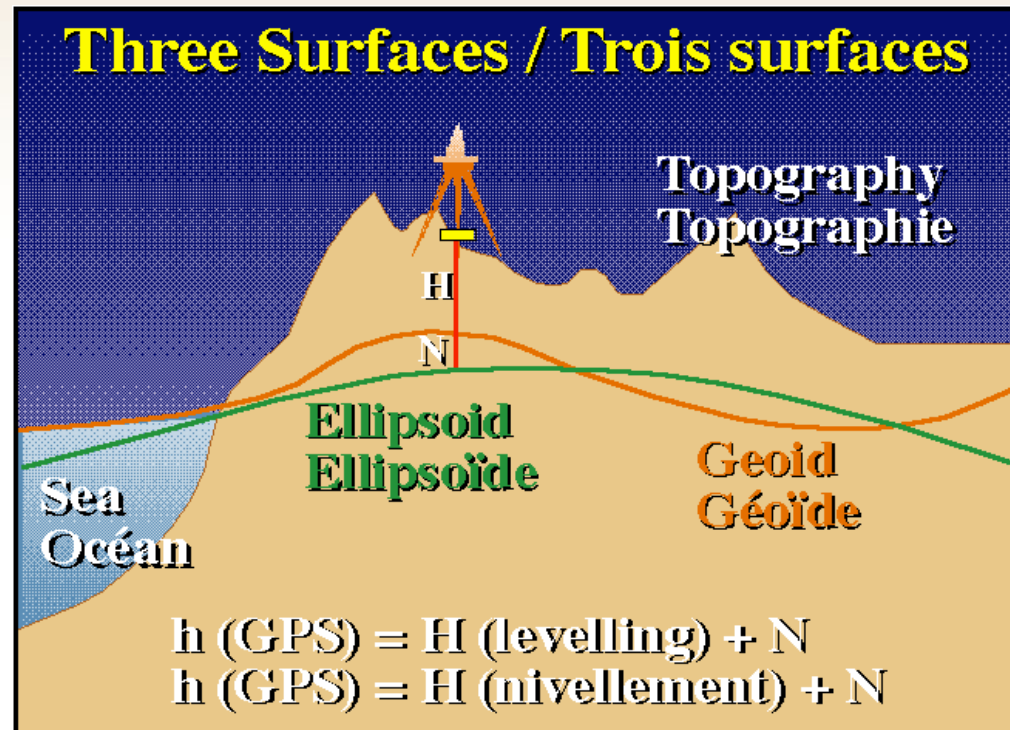

The GPS and leveling data provide the best external ground 'truth' available to validate a gravimetric geoid model.





GPS-Leveling network (Level A)

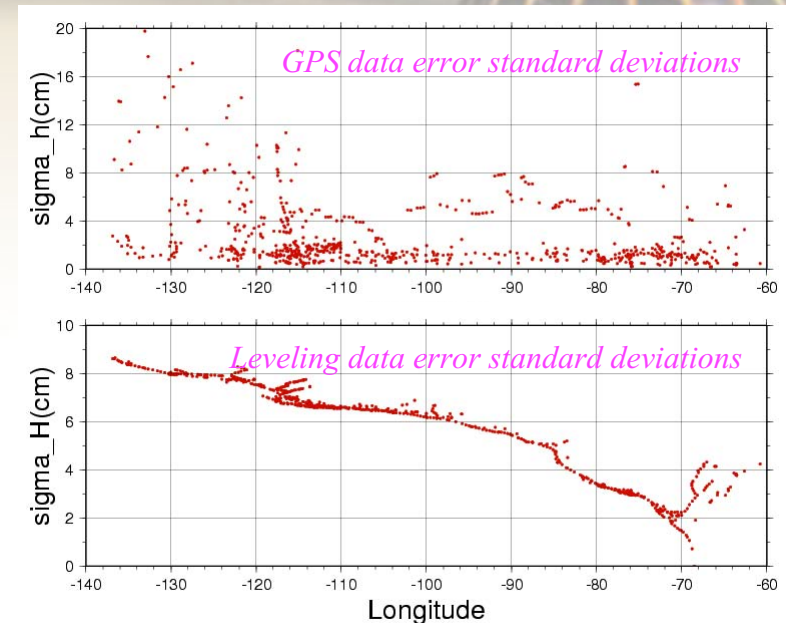
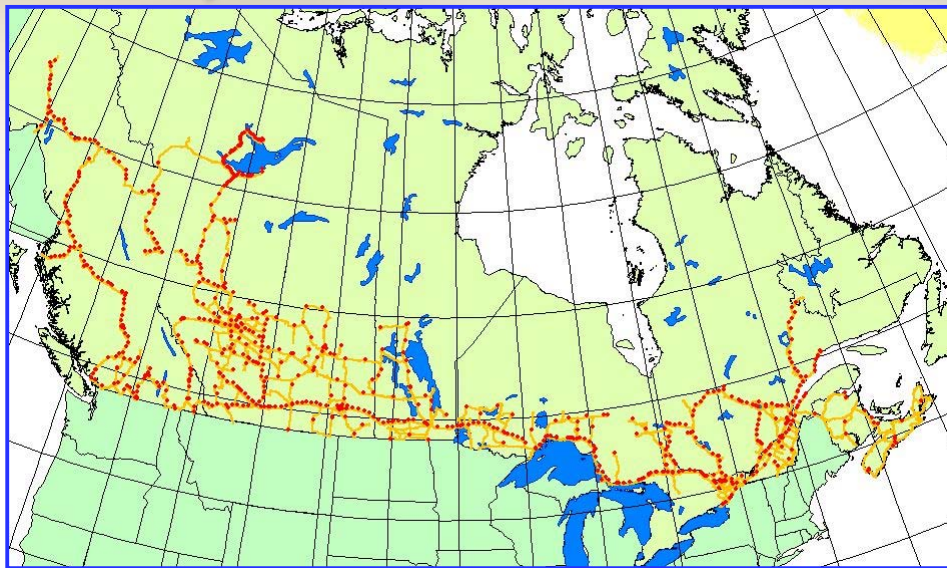

The GPS-Leveling network in Canada.

- A minimum constraint (one point held fix in Rimouski, Quebec) adjustment of geopotential number differences of leveling observations between 1982 and 2002;
- A few extra observations were used from the 70's in order to complete coast to coast connections and closure of some large loops;

- The leveling observations were corrected for four types of systematic errors;
- This adjustment indicates that the water level next to Vancouver is 80 cm higher than the water level next to Halifax. (systematic errors, SST or a mixture of both ?);
- The GPS data were observed between 1986 and 2002 integrated into ITRF97.





Grace gravity models

- GGM01S (CSR, 2003) : The gravity field model derived from 111 days of data without Kaula's constraint, and complete to degree and order 120.
- GGM01C (CSR, 2003) : The combination of GGM01S and TEG4, and complete to degree and order 200.
- GRACE01S (GFZ, 2003): The gravity field model derived from 39 days of data with Kaula's constraint beginning at degree 70 with very low weight, and complete to degree and order 120, plus selected coefficients up to degree 140.
- GRACE01Sup (GFZ, 2003): The gravity field model derived from 62 days of data, complete to degree and order 120 plus selected coefficients up to degree 140.



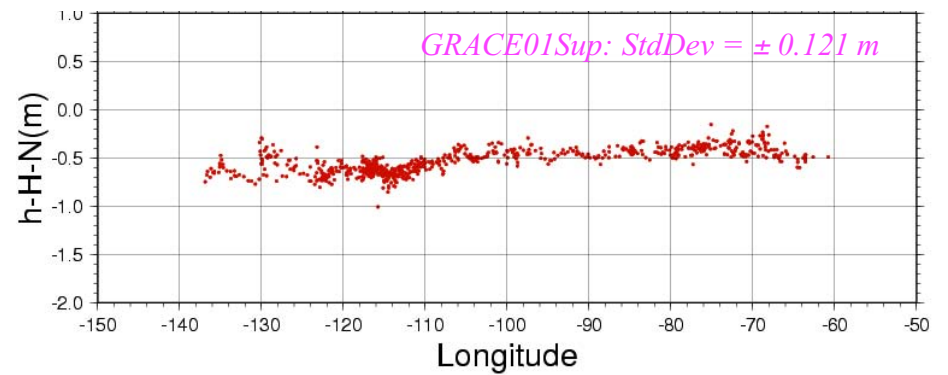
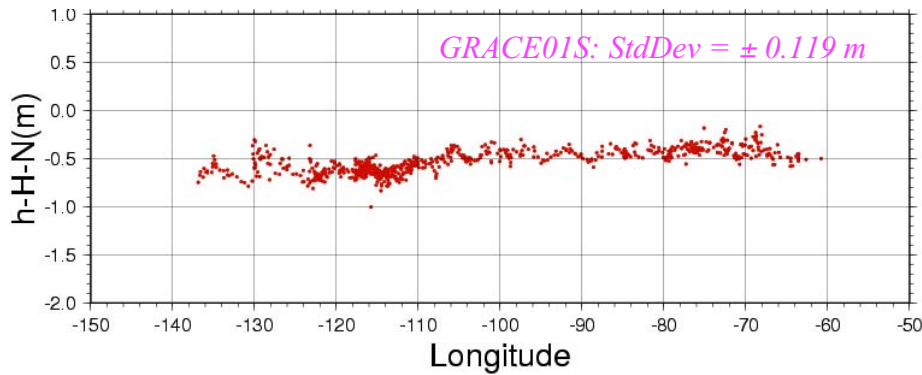
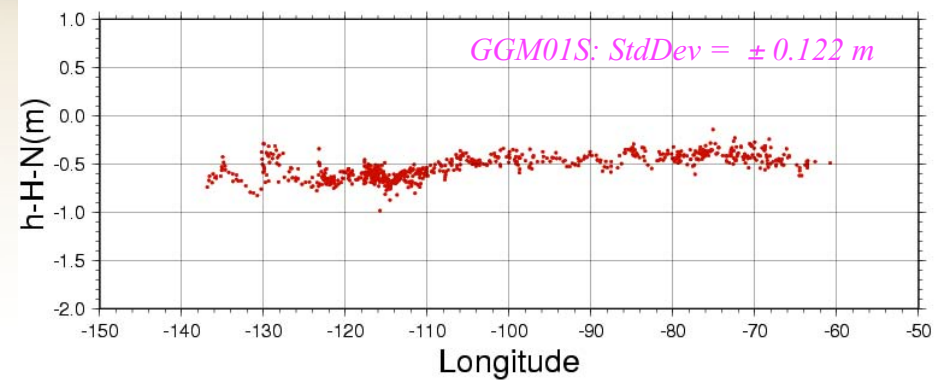
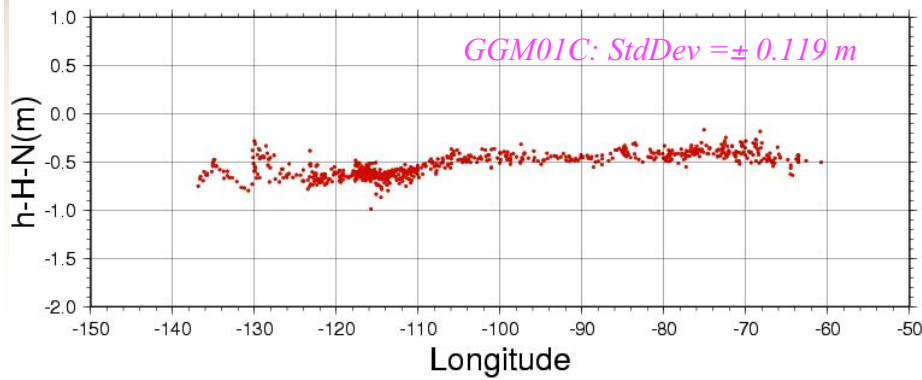
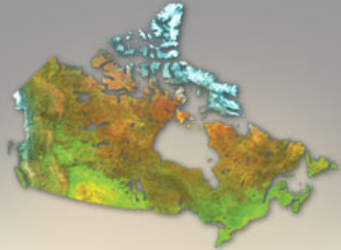

The validation results for degree 30



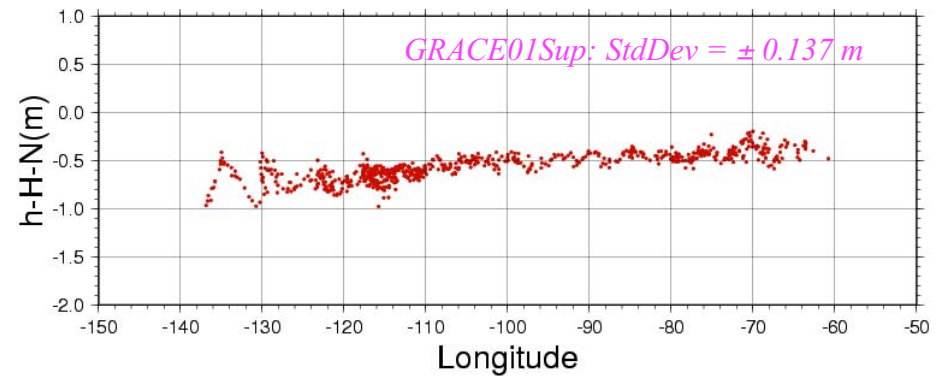
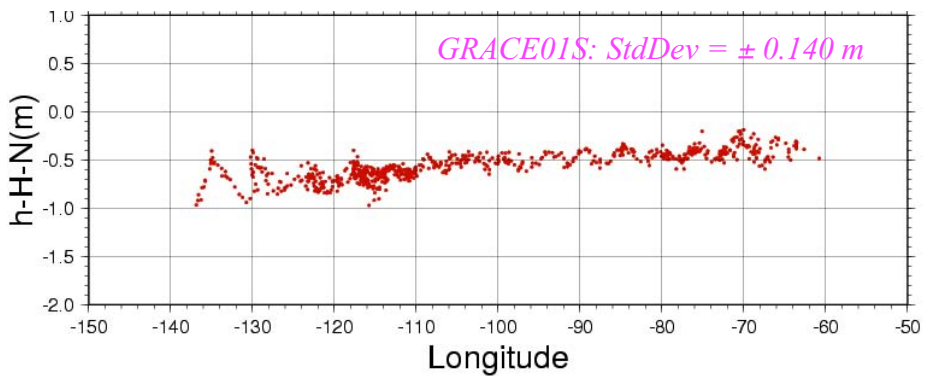
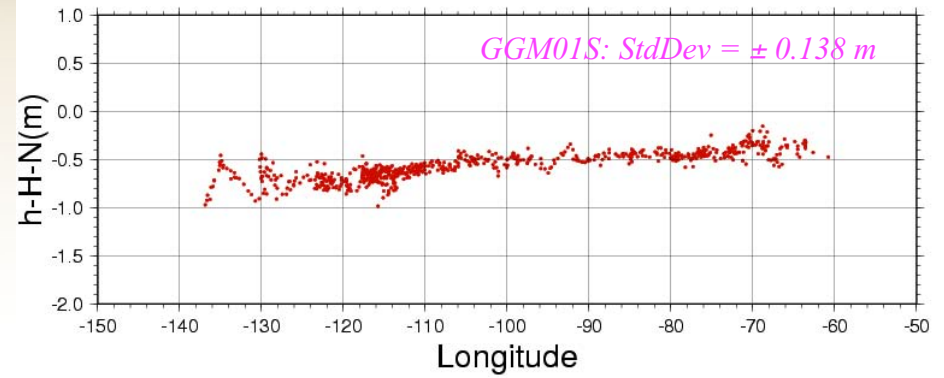
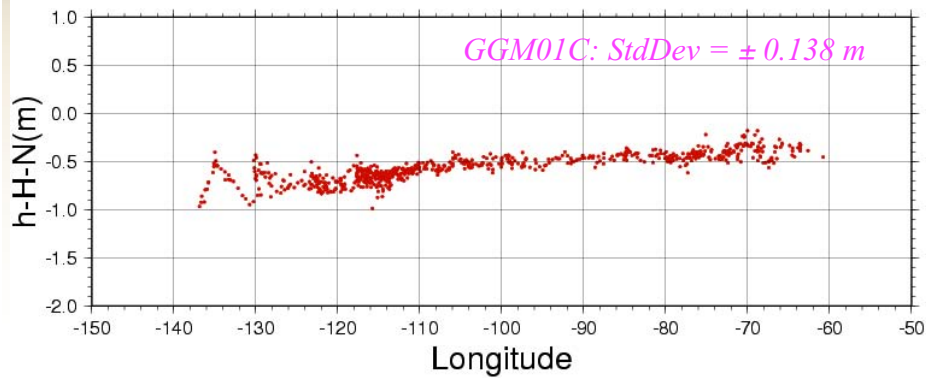

The validation results for degree 60



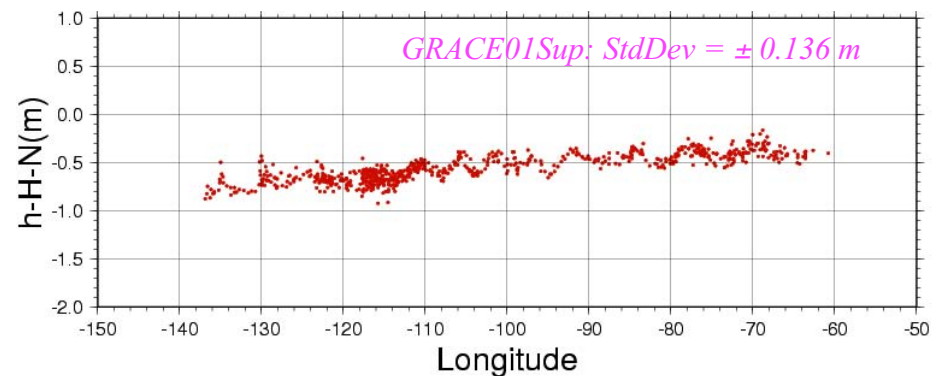
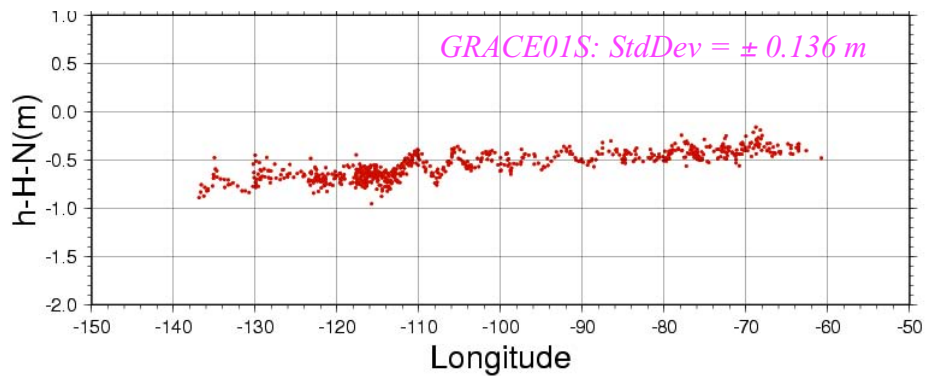
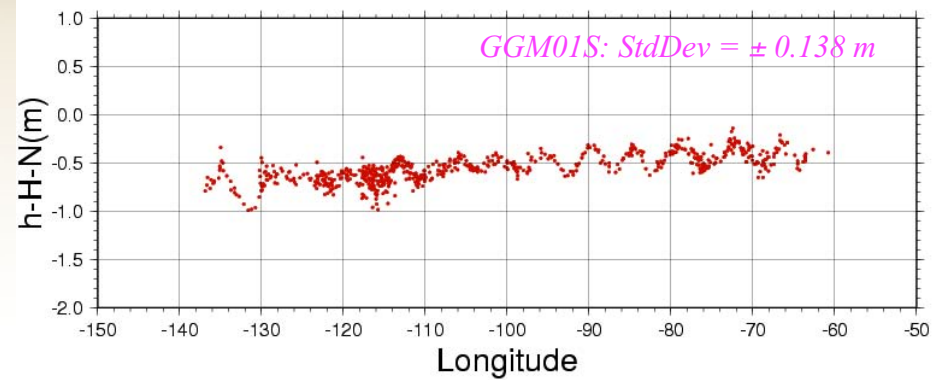
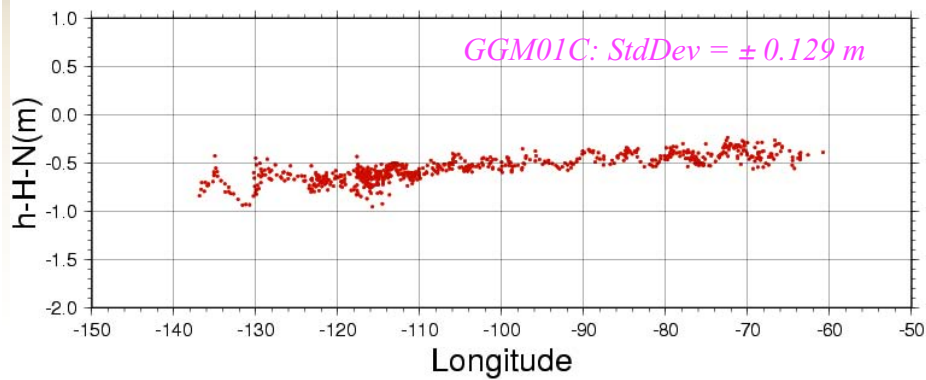
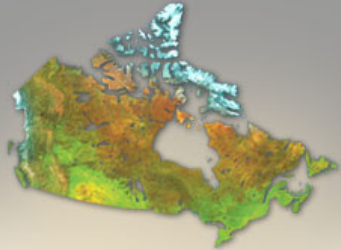

The validation results for degree 90



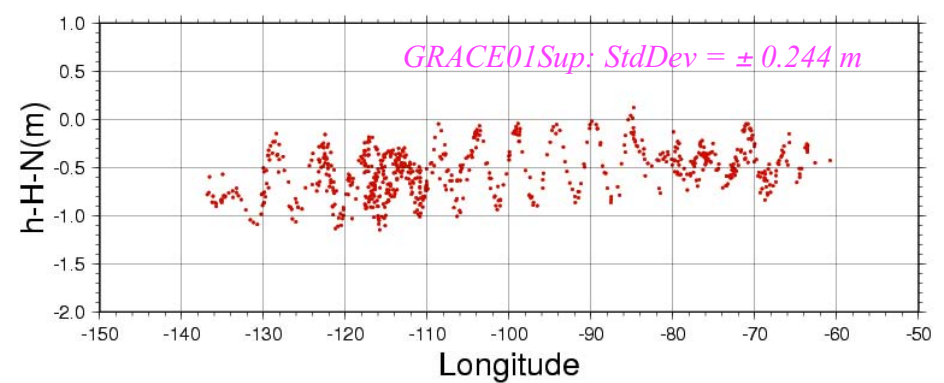
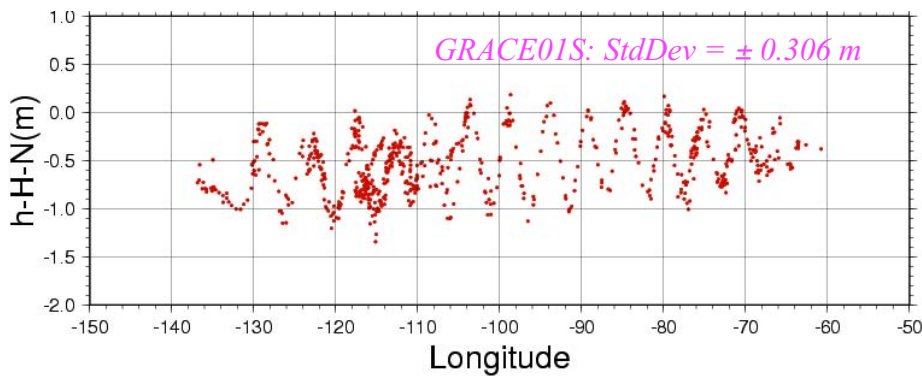
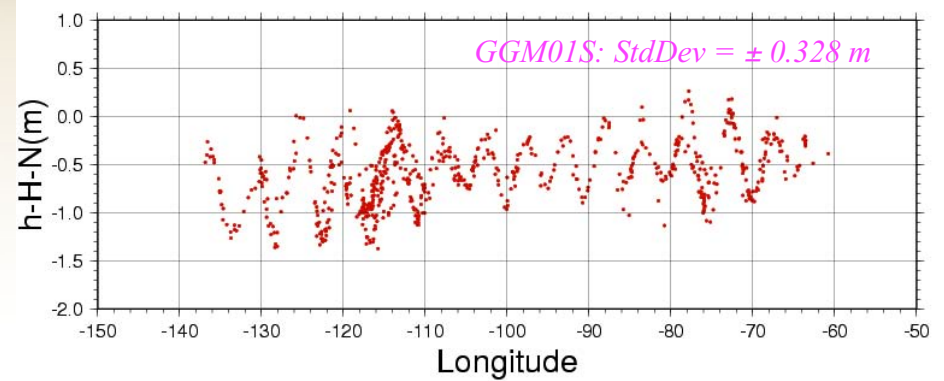
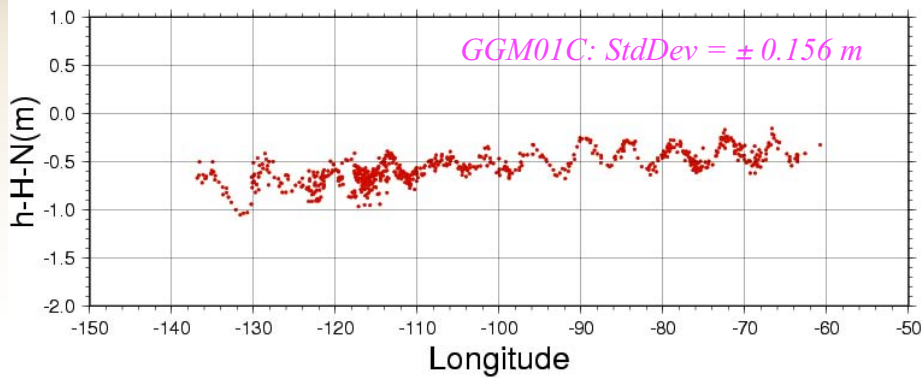

The validation results for degree 120





Preliminary calibration of GRACE models by GPS-Leveling

The differences w between the GPS-Leveling derived geoid heights and the gravimetric geoid heights can be split into :

$$w = v_h - v_H - v_N + Ax \quad v_h, v_H \text{ and } v_N \text{ are random errors; } Ax \text{ stands for biases}$$

$$\Sigma_w = \Sigma_h + \Sigma_H + \Sigma_N \quad \text{Co-variance matrices for } w, h, H \text{ and } N$$

$$v_N = \frac{R}{2\gamma} \sum_{n=2}^l \left(\frac{2}{n-1} + Q_n^{DB} \right) \epsilon_n^{SG} + \frac{R}{2\gamma} \sum_{n=l+1}^{m_{SG}} Q_n^{DB} \epsilon_n^{SG} + \frac{R}{4\pi\gamma} \int_{\psi_0} S_{DB}(\psi) \epsilon_n^{TG} d\Omega' \quad \text{The geoid error}$$

$$v_N = BE_{SG} + SE_{TG} \quad \text{A matrix form for the equation above}$$

$$\Sigma_N = B\Sigma_{SG}B^T + S\Sigma_{TG}S^T \quad \text{The co-variance matrix for } N$$



Given the co-variance matrices for h and H , a prior co-variance matrix for N , the variance factor (or component) for N can be estimated by the Almost Unbiased Estimation (AUE) by Horn et al. (1975) and Lucas (1985).



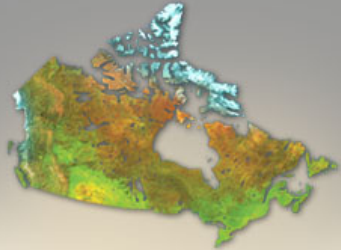

- The total geoid error RMS (black),
- The geoid error RMS from the terrestrial data (green)
- The geoid error RMS from the satellite data (brown).

Unit: cm

Model	Degree 30			Degree 60			Degree 90		
GGM01C	5.6	3.7	4.3	5.7	5.0	2.6	5.4	2.6	4.8
GGM01S	6.6	4.0	5.2	5.7	4.8	3.1	8.0	3.3	7.3
GRACE01S	6.3	3.2	5.4	6.8	5.8	3.5	5.3	1.0	5.2
GRACE01Sup	6.3	3.7	5.2	6.2	5.3	3.2	5.2	1.2	5.1

- For the first calibration test, the off-diagonal elements in the co-variance matrices have been excluded from the computation.
- The degree 30 results are inconsistent because the satellite errors contain an aliasing error coming from systematic biases in the terrestrial data. However, the effect of the biases decreases when using additional (higher degree) satellite signals.



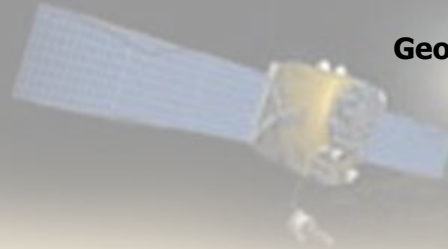

Future Plan

- Remove the systematic biases in the terrestrial gravity data (in progress);
- Take the full co-variance matrices for h , H and N into consideration;
- Calibrate the GRACE gravity models one by one degree;
- Automate the calibration procedure to reduce the turn-around time;
- Refine the method for the geoid determination to reduce possible computational errors (e.g., far zone contribution).



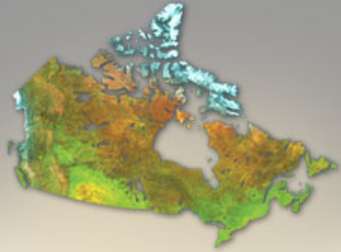

Acknowledgements

- Dr. Chris Reigber, Dr. Peter Schwintzer and Dr. Frank Flechtner from GFZ provided the GRACE models and error information.
- Dr. M. K. Cheng from CSR provided the error information for the GGM01S and GGM01C.
- The GGM01S and GGM01C models were released by CSR.
- Discussions with Ms. Georgia Fotopoulos and Dr. Chris Kotsakis from University of Calgary brought new ideas for the calibration.



***Analysis of Surface Gravity and
Satellite Altimetry Data for Validation
of and Combination with GRACE
Information***

**PI: Nikolaos K. Pavlis (Raytheon ITSS Corp.)
co-I: Steve Kenyon (NIMA)**

npavlis@atlas.stx.com

GRACE Science Team Meeting
UT/CSR
Austin, TX, October 8-10, 2003

Scope

To conduct a comprehensive analysis of up to date detailed surface gravity information, and satellite altimetry data, so that these data sources can be used for:

1. The calibration and validation of the gravitational information acquired from GRACE.
2. The combination of the information contained within these data sources, with the GRACE information, for the development of comprehensive solutions for the geopotential.

General Approach

1. Create normal equations from surface gravimetric data, which will include also systematic bias terms.
2. Create normal equations from satellite altimetry data, which will include Dynamic Ocean Topography (DOT) terms.
3. Combination of the above two sets of normal equations with the normal equations from GRACE data only, will allow one to solve simultaneously for:
 - (a) Geopotential harmonic coefficients.
 - (b) DOT harmonic coefficients.
 - (c) Surface gravity systematic bias terms.

Data Processing Highlights

1. Exploit the *geometric* mapping of the Earth's surface (e.g., from SRTM and ICESat), and the fact that NIMA has access to the original point gravity measurements, to form area-averages ($1^{\circ} \times 1^{\circ}$, $30' \times 30'$) of gravity disturbances. These values are independent of vertical datum inconsistencies.
2. Approximately 13 million point gravity measurements are currently available within NIMA, *in addition* to the 30 million values available when EGM96 was developed.
3. Satellite altimetry in the form of a gridded Mean Sea Surface (MSS) offers the most economic means of incorporating altimetry into combination solutions, without compromising the accuracy of the resulting model.

First Year Plan

1. Analyze existing gravity anomaly ($1^\circ \times 1^\circ$) and MSS data, and form the corresponding normal equations.
2. Perform preliminary combination solutions with existing GRACE information, to investigate issues of DOT and surface gravity bias terms resolution versus estimability.
3. The error covariance matrix from one of the currently available GRACE-only models (e.g., GGM01S) is required to investigate the issues described in (2).
4. Begin the prediction of gravity disturbance area-mean values.
5. Preliminary results from the evaluation of the GGM01 models are available via anonymous ftp to: [atlas.stx.com](ftp://atlas.stx.com) under the directory: [pub/dist/nikos/GRACE/ggm01](ftp://pub/dist/nikos/GRACE/ggm01)

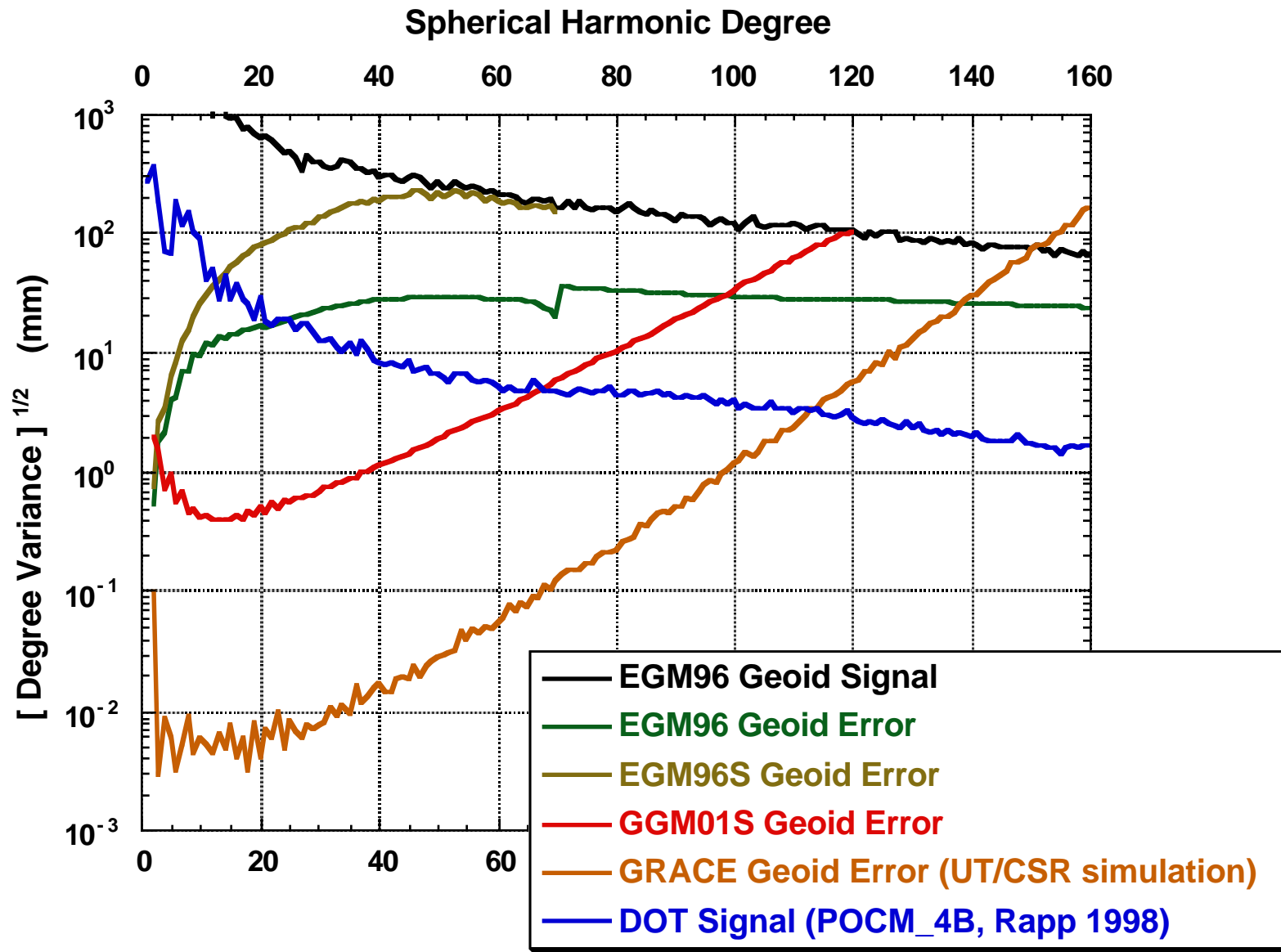
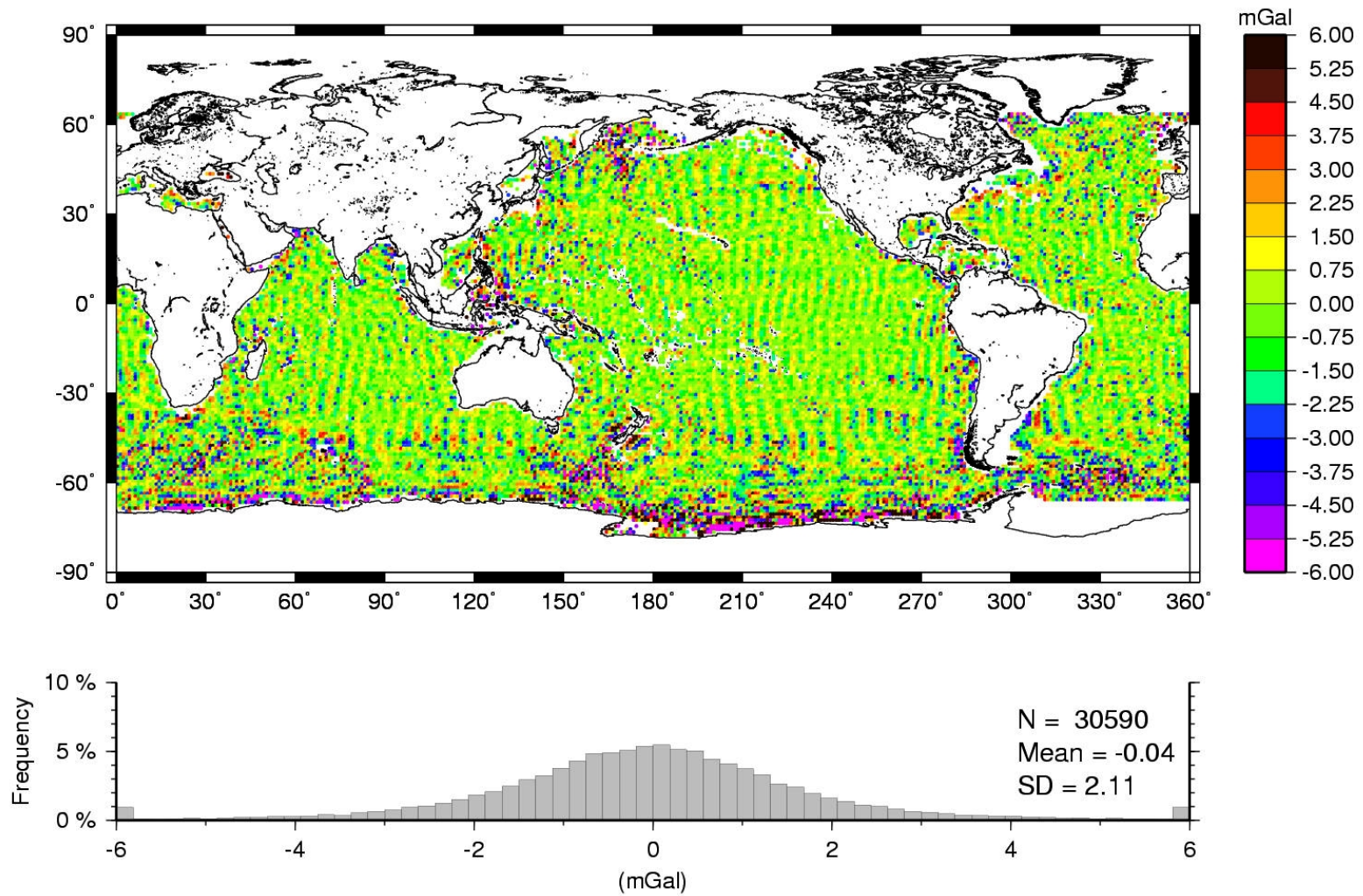
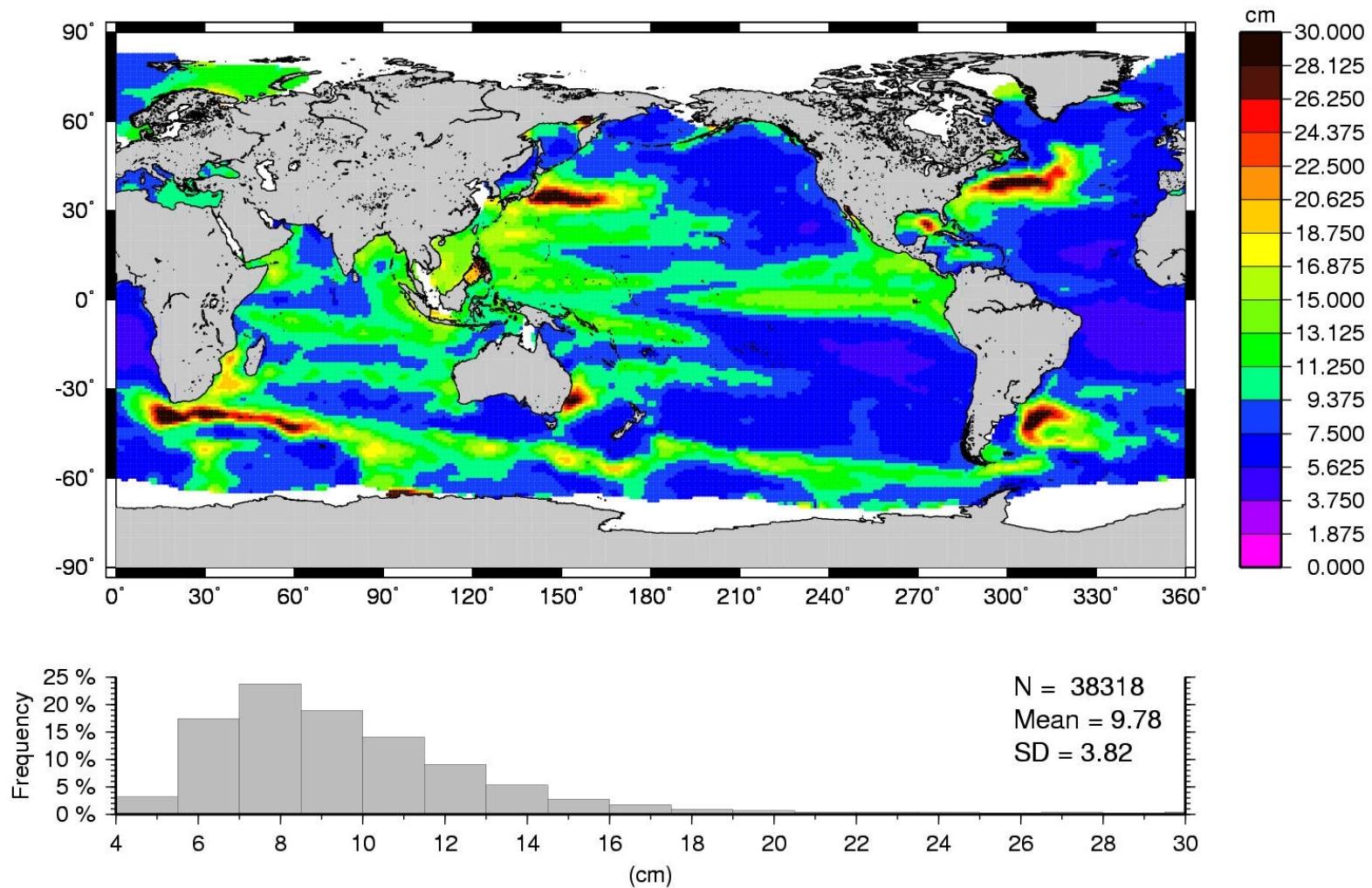

Figure 1. Degree Amplitude Spectra.

Gravity Anomaly Diff. Altimetry - GGM01S (Nmax=90)



1 Deg. T/P + ERS-2 Sea Surface Height Variability



Edited Gravity Anomaly Diff. Altimetry - GGM01S (Nmax=90)

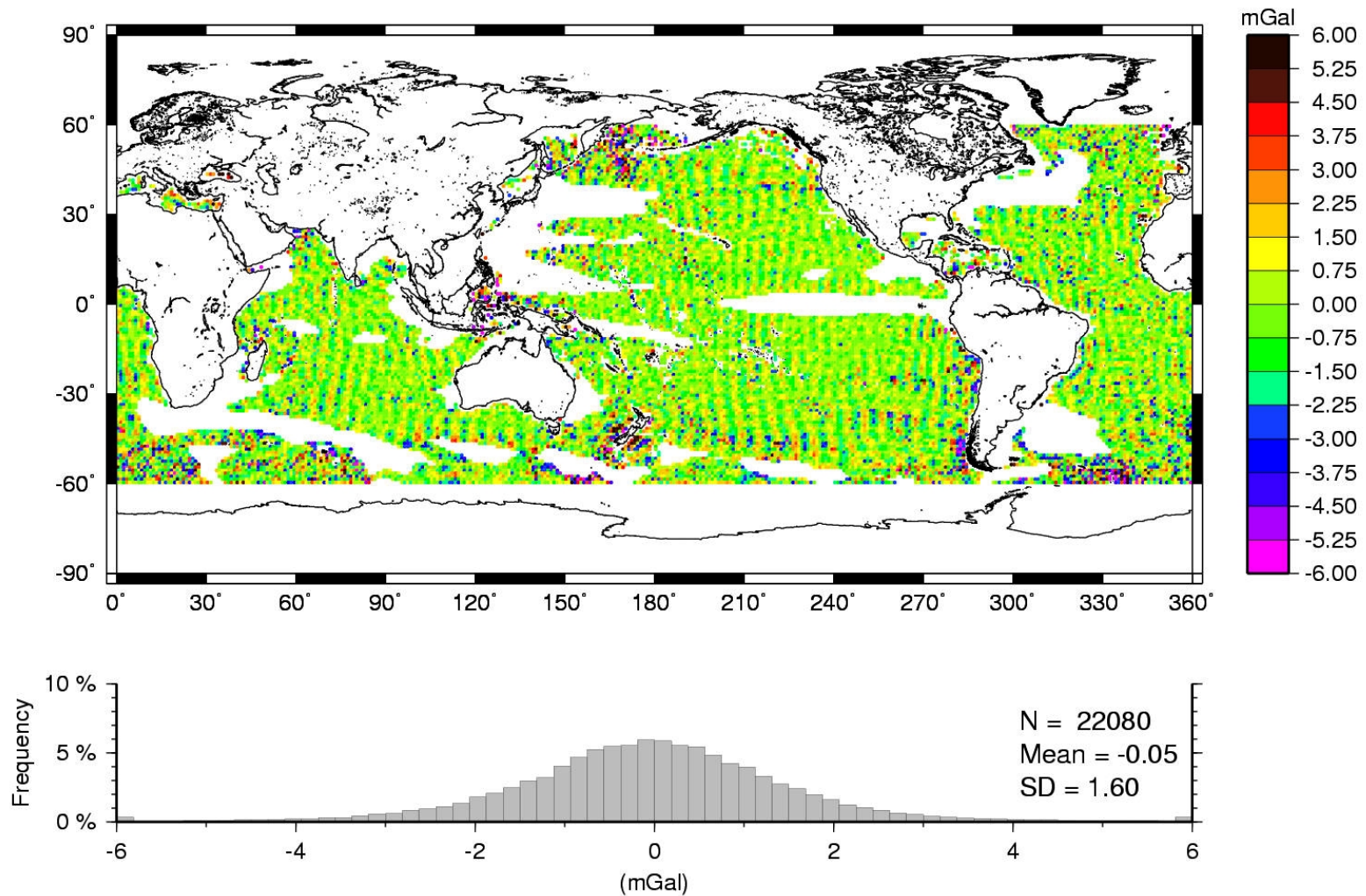

Gravity Anomaly Differences (1°x1° Mean Values)
Sampled Along a Parallel at: $\phi = -25.50^\circ$
Altimetry - GGM01S (Nmax=90)

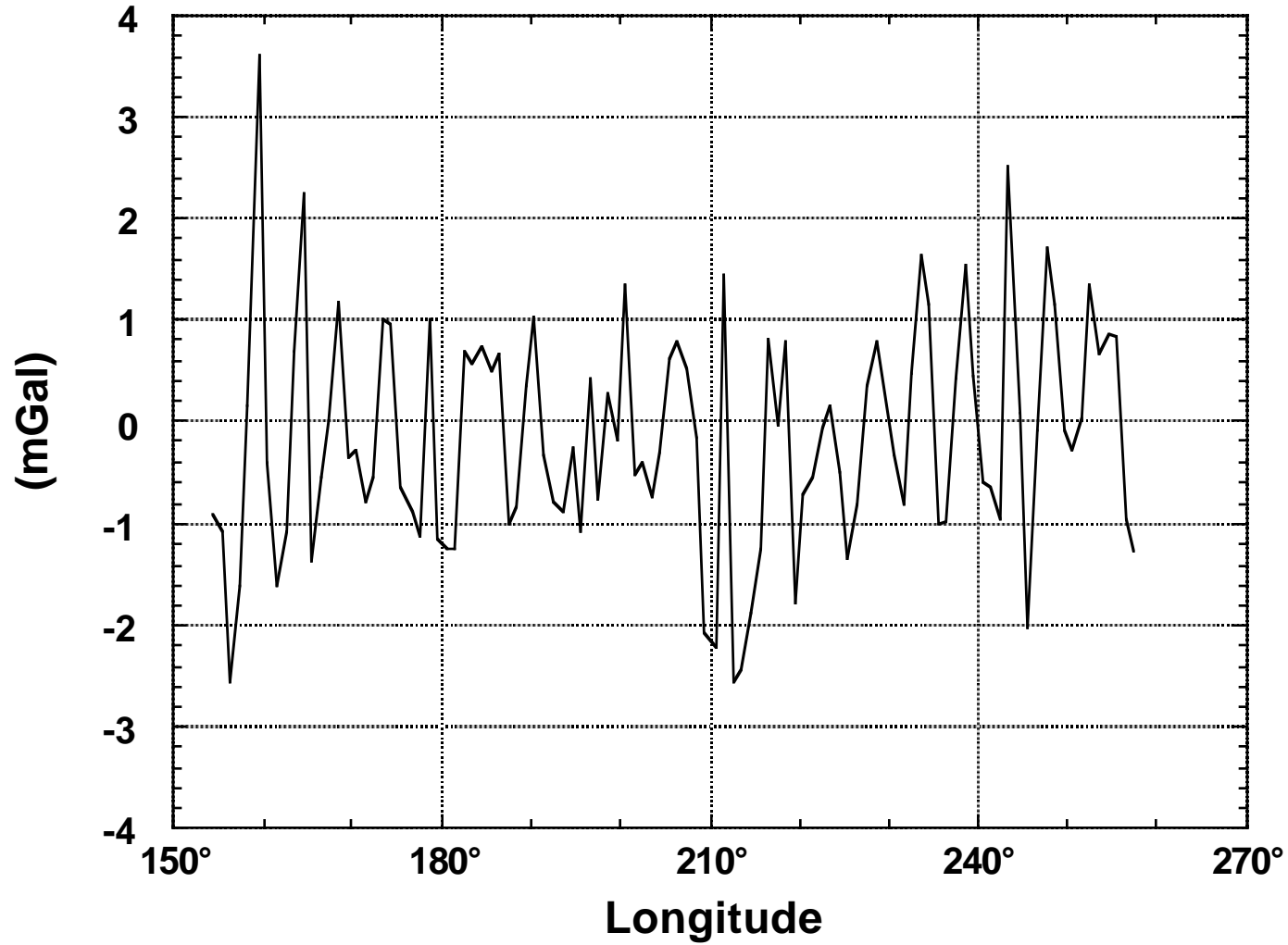

Geoid Undulation Differences (30'x30' Mean Values)
Sampled Along a Parallel at: $\phi = -25.25^\circ$
EGM96 - GGM01S (Nmax=90)

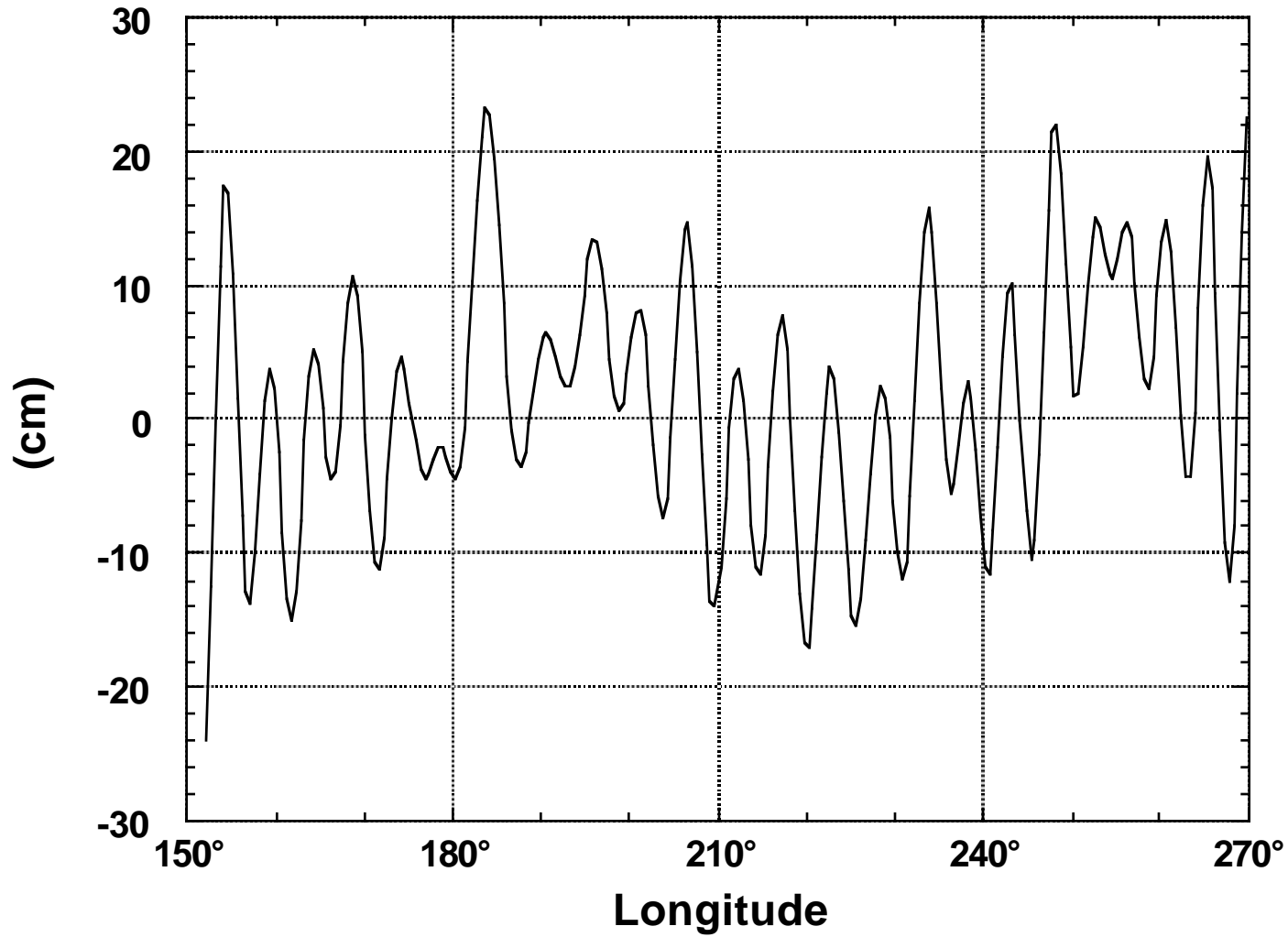

Comparison With 22080 1°x1° Altimeter-Derived Δg
 Corrected for Truncation Effects Above the Maximum Degree
 of the Model Tested (N_{max})

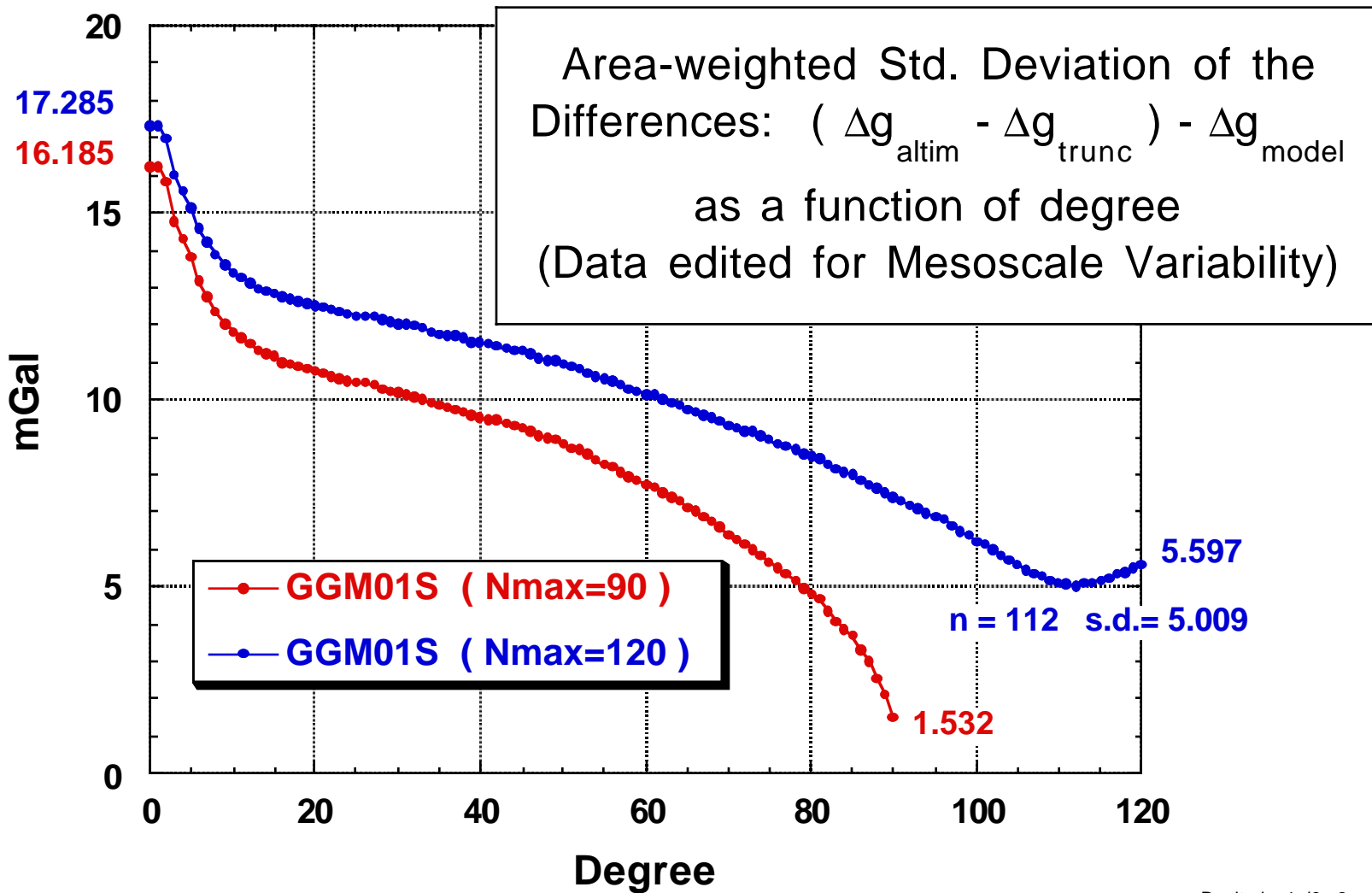

A Preliminary Error Calibration of GGM01S

The $1^\circ \times 1^\circ$ altimetric Δg comparison permits also some inferences to be made about the error calibration of the GGM01S model as follows.

1. An estimate of the GGM01S-implied cumulative global RMS error in $1^\circ \times 1^\circ$ area-mean Δg can be obtained from its coefficient errors, using the Pellinen smoothing operators (β_n) that correspond to a 1° capsize. Up to degree and order 90, this computation yields **± 0.643 mGal**.
2. Since the GRACE-only GGM01S model does not discriminate between land and ocean, this error estimate should be a fairly accurate indicator of the propagated error that the GGM01S model implies for $1^\circ \times 1^\circ$ area-mean Δg over the area of our altimetric Δg comparisons. (A more precise computation requires propagation of the GGM01S error covariance matrix to degree 90, onto $1^\circ \times 1^\circ$ area-mean Δg .)
3. The standard deviation of the differences between our $1^\circ \times 1^\circ$ area-mean altimetric Δg and **independent** marine $1^\circ \times 1^\circ$ area-mean Δg from NIMA was **± 0.912 mGal**.

4. Therefore, a rather pessimistic estimate (since the NIMA marine data are not error-free) of the RMS error of our 1°x1° altimetric Δg may be **±0.9 mGal**.
5. The results of our altimetric comparison (to degree 90, using the 22080 altimetric Δg that were edited for mesoscale variability), and the above reasoning, imply that the GGM01S error in 1°x1° area-mean Δg (to degree 90) may be approximately:

$$\sqrt{1.532^2 - 0.9^2} = \pm 1.24 \text{ mGal}$$

This implies that the cumulative global RMS error in 1°x1° area-mean Δg that is predicted by the GGM01S error estimates may be too optimistic by approximately a factor of two (1.24/0.64).

Caution: This assessment is preliminary!

Additional work is needed to calibrate/validate the error estimates of GGM01S.



*Goddard
Space
Flight
Center*

Current and Future Satellite Mission Data Analysis for Gravity Field and Reference Frame Implementation

Erricos C. Pavlis

Joint Center for Earth Systems Technology - JCET
University of Maryland Baltimore County - UMBC

JCET

10/09/2003

GRACE Science Team Meeting,
CSR, Texas



1



Geoid Error Spectra



Goddard
Space
Flight
Center

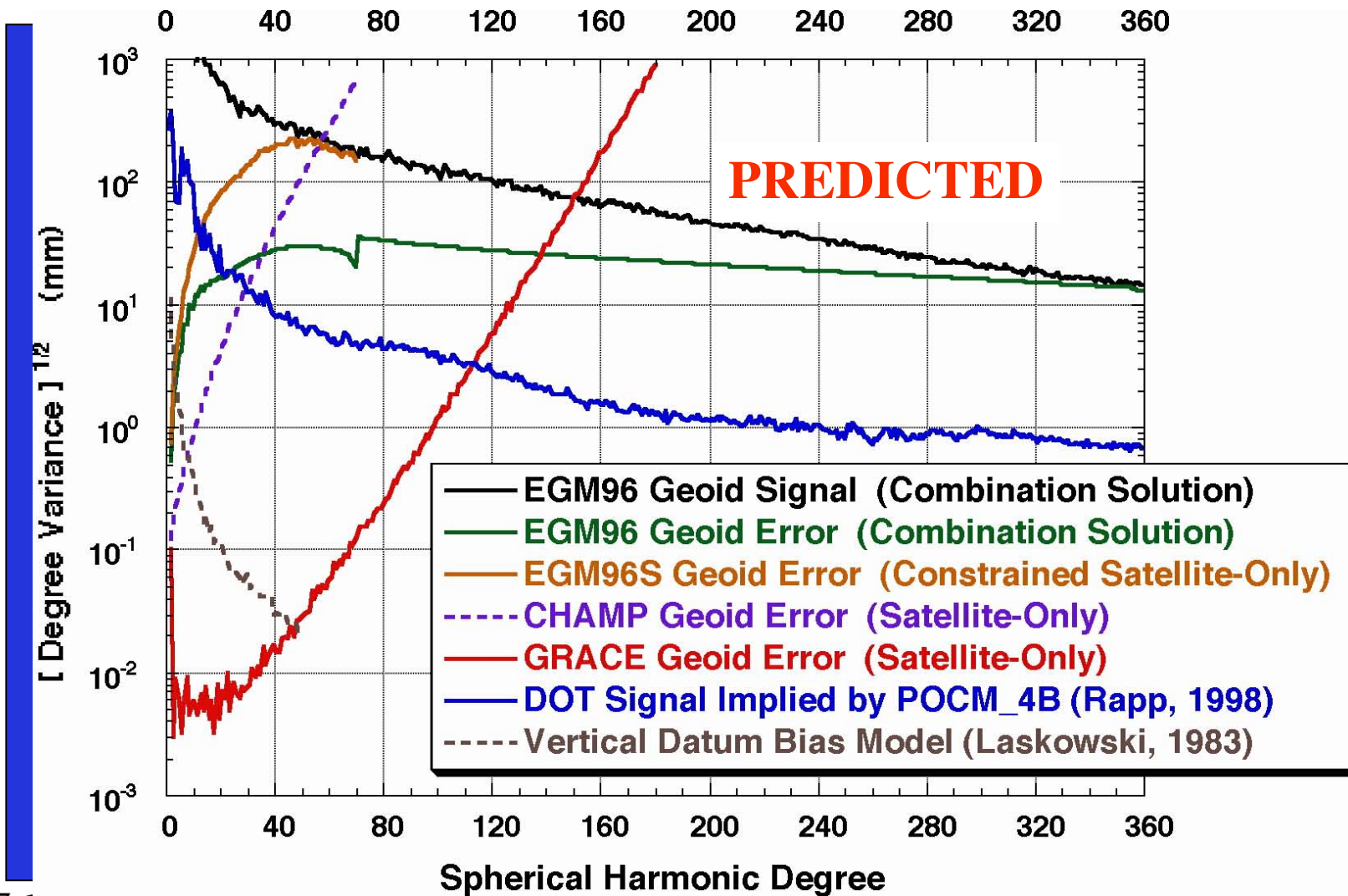

JCET

10/09/2003

GRACE Science Team Meeting,
CSR, Texas





Project Objectives



*Goddard
Space
Flight
Center*

- **Contribute the long-wavelength part in the development of a new high degree gravity model**
- **Use primarily data from CHAMP, GRACE, and GOCE in the future**
- **Products should anticipate the future incorporation of:**
 - **NIMA's latest surface gravity data**
 - **Satellite altimetry from T/P, JASON, ENVISAT...**
- **Model/estimate temporal gravity variations**





Motivation



*Goddard
Space
Flight
Center*

Temporal variations due to mass redistribution within the Earth system cannot be ignored anymore when establishing a modern Reference System.

We are therefore interested in incorporating GRACE products, as well as in the use of the GRACE data directly.



Data & Products of Interest



*Goddard
Space
Flight
Center*

- **Very long wavelength variations from precise tracking techniques (e.g. SLR)**
- **GRACE SST tracking (H-L and L-L) for static gravity modeling**
- **GRACE “monthly model” products for temporal variation modeling**

JCET

10/09/2003

GRACE Science Team Meeting,
CSR, Texas



5



Data & Products Available



*Goddard
Space
Flight
Center*

- **Long wavelength variations from precise tracking techniques (SLR)**
- **First degree time series (weekly, 1993-...)**
- **Second degree time series (weekly, 1993-...)**
- **Independently developed multi-satellite static model**

JCET

10/09/2003

GRACE Science Team Meeting,
CSR, Texas



6



Geoid Error Spectra - RESULTS



Goddard Space Flight Center

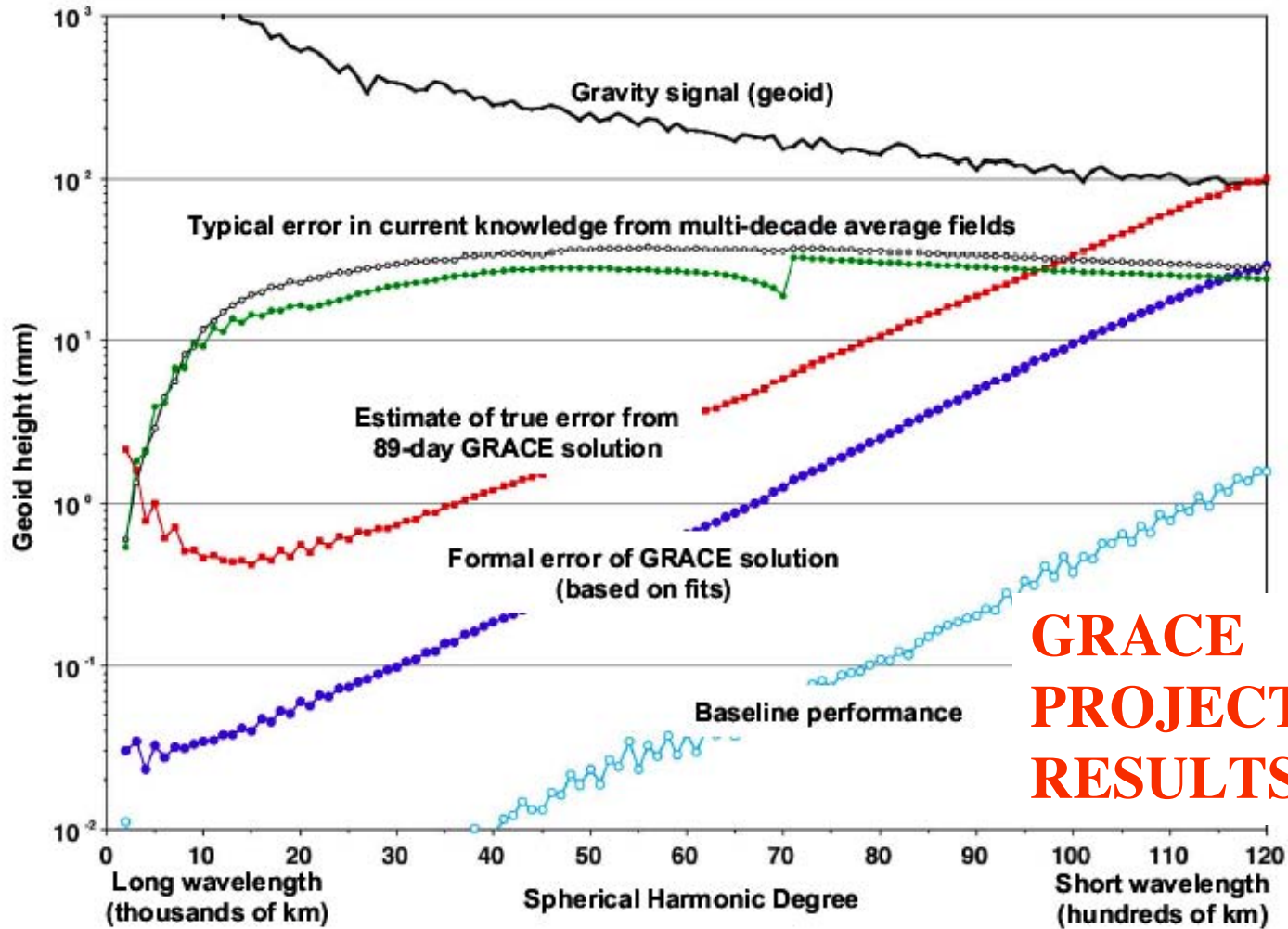

GRACE PROJECT RESULTS

JCET

10/09/2003

GRACE Science Team Meeting,
CSR, Texas





TRF Origin (“geocenter”)



Goddard
Space
Flight
Center

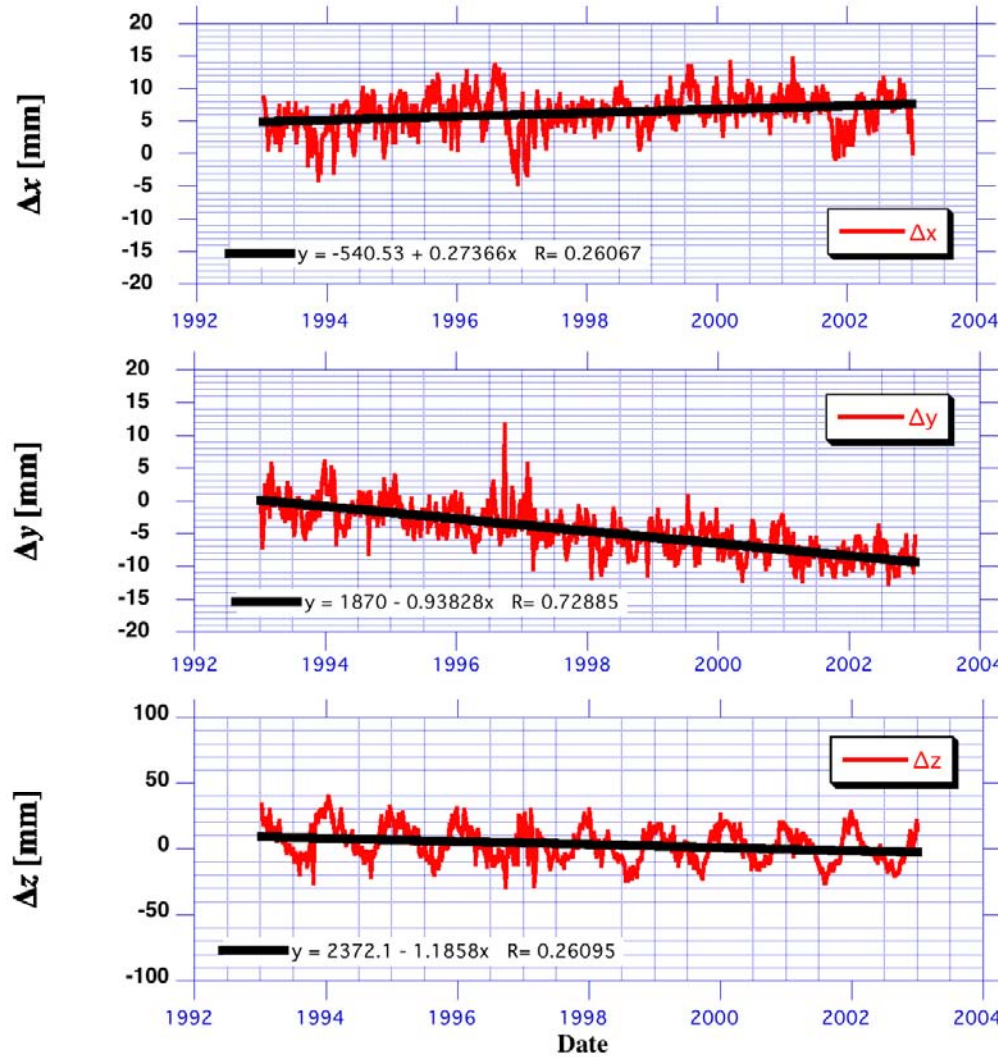

JCET

10/09/2003

GRACE Science Team Meeting,
CSR, Texas





Zonal Variations - J_2



Goddard
Space
Flight
Center

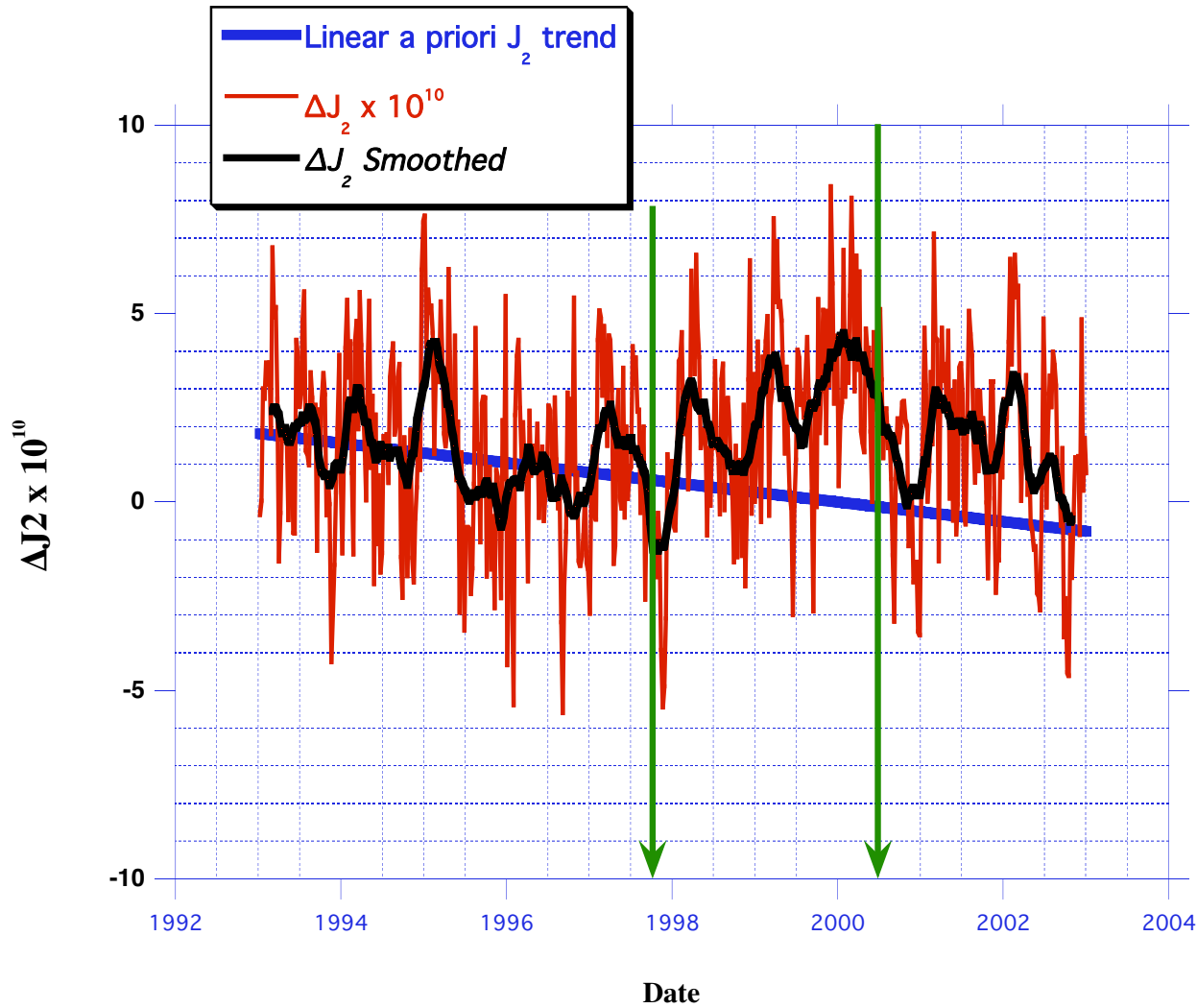

JCET

10/09/2003

GRACE Science Team Meeting,
CSR, Texas





Axis of Figure



Goddard
Space
Flight
Center

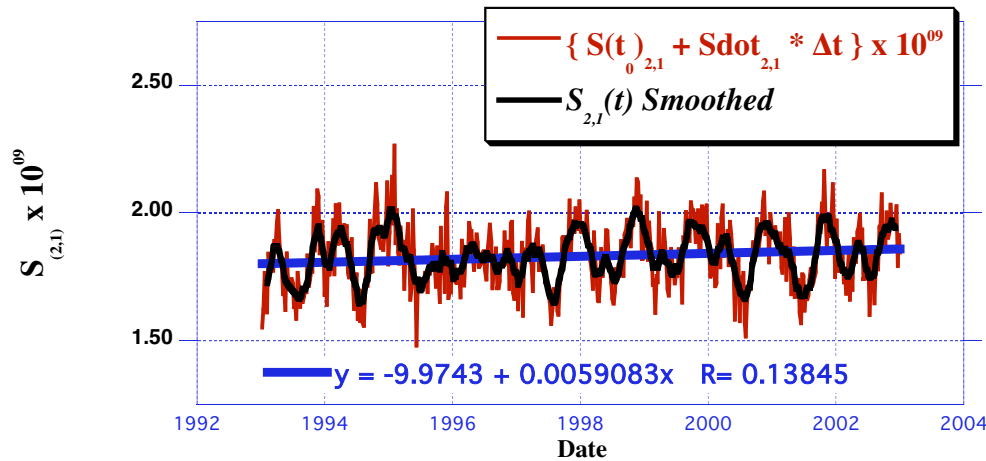
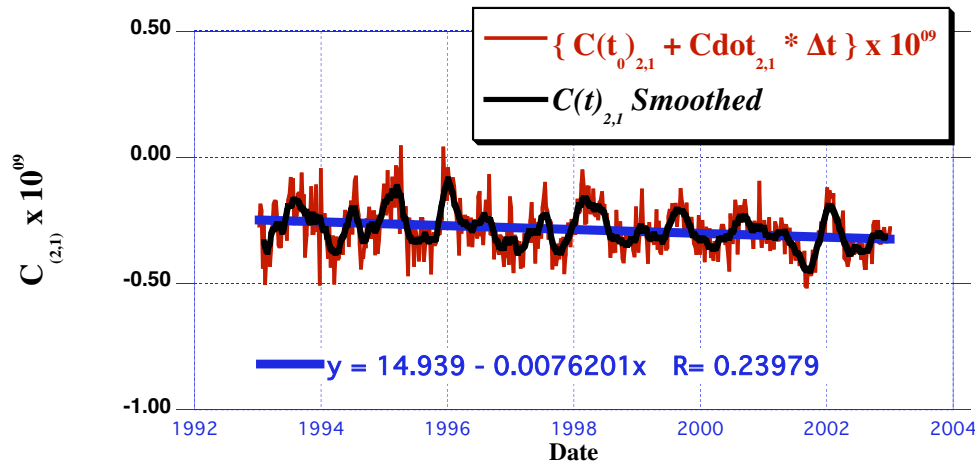

JCET

10/09/2003

GRACE Science Team Meeting,
CSR, Texas





Equatorial Flattening



Goddard
Space
Flight
Center

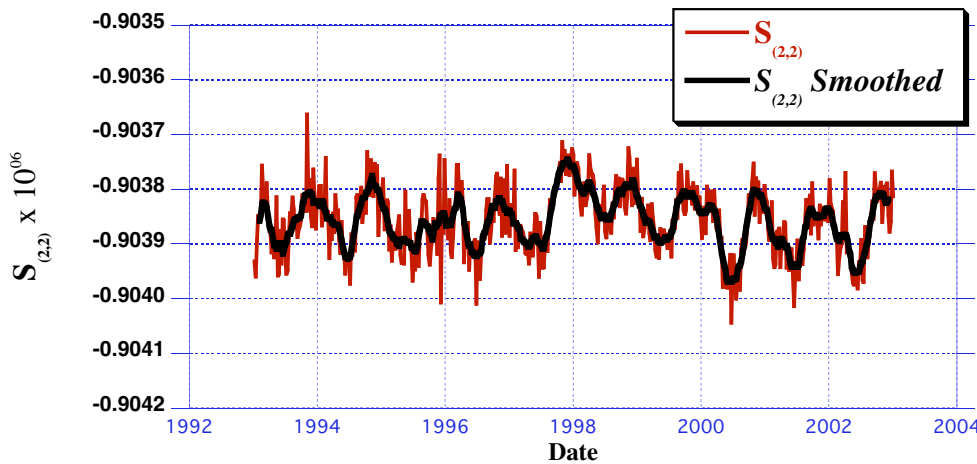
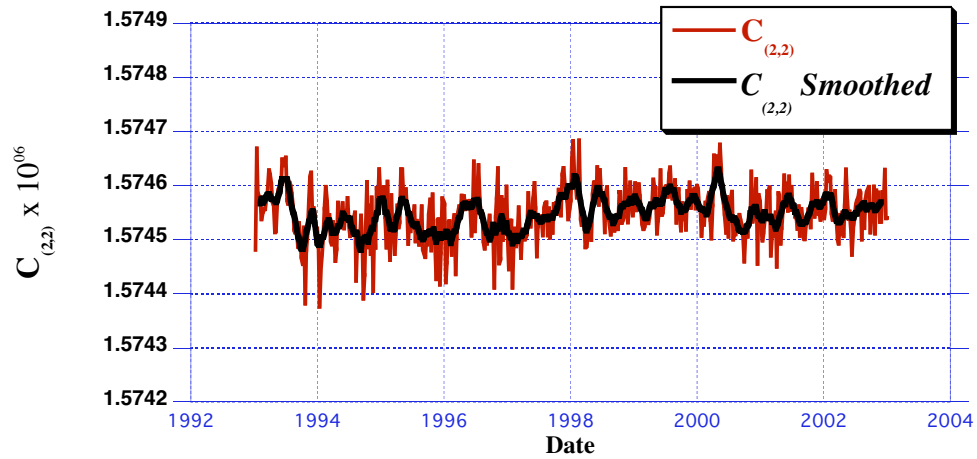

JCET

10/09/2003

GRACE Science Team Meeting,
CSR, Texas



(NASA SENH GRACE Investigation)

**Validation of GRACE Data Products and
Development of High-Resolution Regional Gravity Field Models**

PI's: Christopher Jekeli, Shin-Chan Han, C.K. Shum

Laboratory for Space Geodesy and Remote Sensing Research

Department of Civil and Environmental Engineering and Geodetic Science

Ohio State University

Presented at GRACE Science Team Meeting, Univ. of Texas at Austin, Oct. 8~10, 2003



Objectives of the proposed investigation

- Apply an **alternative data processing methodology** based on the energy relationship of the satellites for the following purposes:
- **Validate the GRACE gravitational measurements** (potential and LOS acceleration) by a direct comparison between the on-orbit derived quantities and corresponding model values predicted at altitude through forward modeling (**upward continuation**). The mean (or static) signals can be predicted from existing, extensive gravity data bases, e.g. in the U.S. and the Arctic region, Dronning Maud Land site. The time-varying signal, based on monthly averages, can be estimated from global tidal, atmospheric, oceanic, continental hydrologic, and ice mass models.
- **Develop and study high-resolution regional gravity model and crustal deformations.** By using **downward continuation** applied to the local, in situ (potential and LOS acceleration) data, we are better able to exploit the high density of GRACE measurements generated in the polar region. We propose to test our resulting models in the Arctic (with NIMA's terrestrial data) and thus provide regional gravity model and its predicted accuracy for the model in the Antarctic.



In situ measurement models

- Disturbing potential difference – range-rate

$$T_{12} = \left| \tilde{\mathbf{x}}_1^i \right| \cdot \ddot{\mathbf{a}}\tilde{\mathbf{n}}_{12} + \left(\tilde{\mathbf{x}}_2^i - \left| \tilde{\mathbf{x}}_1^i \right| \mathbf{e}_{12} \right) \dot{\mathbf{x}}_{12}^i + \left(\ddot{\mathbf{x}}_1^i - \left| \tilde{\mathbf{x}}_1^i \right| \ddot{\mathbf{a}}\mathbf{e}_{12} \right) \tilde{\mathbf{x}}_{12}^i + \ddot{\mathbf{x}}_1^i \cdot \ddot{\mathbf{x}}_{12}^i + \frac{1}{2} \left| \ddot{\mathbf{x}}_{12}^i \right|^2 - \ddot{\mathbf{a}}\mathbf{R}\mathbf{E}_{12} - \mathbf{F}\mathbf{E}_{12} + \text{const.}$$

where

$$\ddot{\mathbf{a}}\mathbf{R}\mathbf{E}_{12} \equiv \dot{u}_e \left(x_2^i \dot{y}_2^i - y_2^i \dot{x}_2^i - x_1^i \dot{y}_1^i + y_1^i \dot{x}_1^i \right) - \dot{u}_e \left(\tilde{x}_2^i \tilde{y}_2^i - \tilde{y}_2^i \tilde{x}_2^i - \tilde{x}_1^i \tilde{y}_1^i + \tilde{y}_1^i \tilde{x}_1^i \right)$$

$$\mathbf{F}\mathbf{E}_{12} \equiv \int \left(\mathbf{F}_2^{\text{srf}} \cdot \dot{\mathbf{x}}_2^{\text{srf}} - \mathbf{F}_1^{\text{srf}} \cdot \dot{\mathbf{x}}_1^{\text{srf}} \right) dt$$

- Gravity disturbance difference – LOS (line-of-sight) acceleration

$$\begin{aligned} \ddot{\mathbf{a}}\mathbf{g}_{12}^i &\equiv \mathbf{e}_{12} \cdot \ddot{\mathbf{a}}\mathbf{g}_{12}^i \\ &= \tilde{\mathbf{n}}_{12} - \mathbf{e}_{12} \cdot \left(\tilde{\mathbf{a}}_{12}^i + \mathbf{F}_{12}^i \right) - \frac{1}{\tilde{\mathbf{n}}_{12}} \left(\left| \dot{\mathbf{x}}_{12}^i \right|^2 - \tilde{\mathbf{n}}_{12}^2 \right) \end{aligned}$$

N.B. GRACE **Level1B data** will be used to generate these in situ measurements.



Internal validation (consistency check): geopotential difference (cont'd)

Difference b.t. GGM01S and other models (EGM96, EIGEN2, EIGEN-GRACE01S) derived V_{12} . N.B. arbitrary biases were added for distinct plots.

EIGEN-GRACE01S(120) – GGM01S(120):

s.d. = 0.0023 m^2/s^2

EIGEN2(120) – GGM01S(120):

s.d. = 0.1289 m^2/s^2

EIGEN_GRACE01S(120) – GGM01S(120):

s.d. = 0.0023 m^2/s^2

GGM01S(120) – GGM01S(90):

s.d. = 0.0055 m^2/s^2

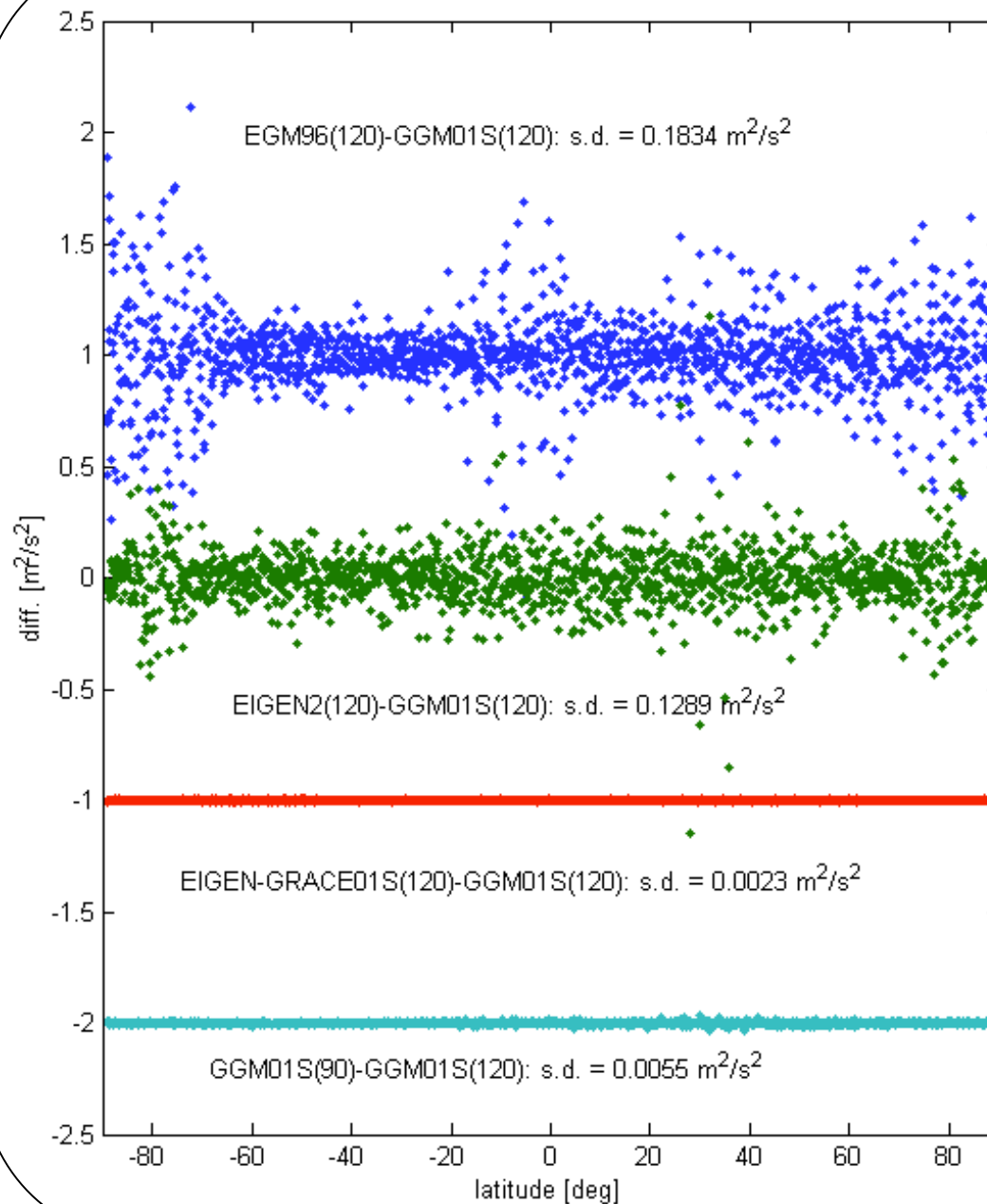

Accuracy requirement

- range-rate accuracy $\sim 1 \mu\text{m/s}$ (much better precision is expected from the current mission)
- geopotential accuracy $\sim 0.01 \text{ m}^2/\text{s}^2$ (approximately 1 mm geoid difference)
- LOS accuracy $\sim 0.01 \text{ mgal}$
- required orbit accuracy
 - a few tens cm accuracy of absolute position
 - $50 \mu\text{m/s}$ accuracy of absolute velocity
 - 1 mm-accuracy of relative position
 - $20 \mu\text{m/s}$ accuracy of relative velocity
- The registration or coordinatization of the observable causes error as well, because of the imperfect orbit. However, the GRACE difference observable is not very sensitive to this error, because the orbit errors of the two satellites would be highly correlated.



Validation (Upward continuation)

The theoretical basis is the Poisson's integral which relating the harmonic function defined on the surface and the one on the exterior space. The necessary Green's functions are the Stokes kernel which is depending on the inverse of distance and the inverse of distance cube function.

ground control data

$$T(r, \vartheta, \varphi) = \frac{R}{4\pi} \iint_{\sigma} \Delta g(R, \vartheta', \varphi') \cdot S(R, r, \vartheta) d\sigma$$

$$\Delta g(r, \vartheta, \varphi) = \frac{R^2 (r^2 - R^2)}{4\pi r} \iint_{\sigma} \frac{\Delta g(R, \vartheta', \varphi')}{l^3} d\sigma$$

In situ data at altitude
from GRACE Level1B data

Based on the dense surface gravity data, in situ potential and gravity measurements computed using GRACE Level1B data would be validated with the upward-continued surface data. Especially, it will give a good constraint for the unknown systematic error in the accelerometer data. e.g., Dronning Maud Land, Antarctica, gravimeter network



Arctic gravity anomaly comparison

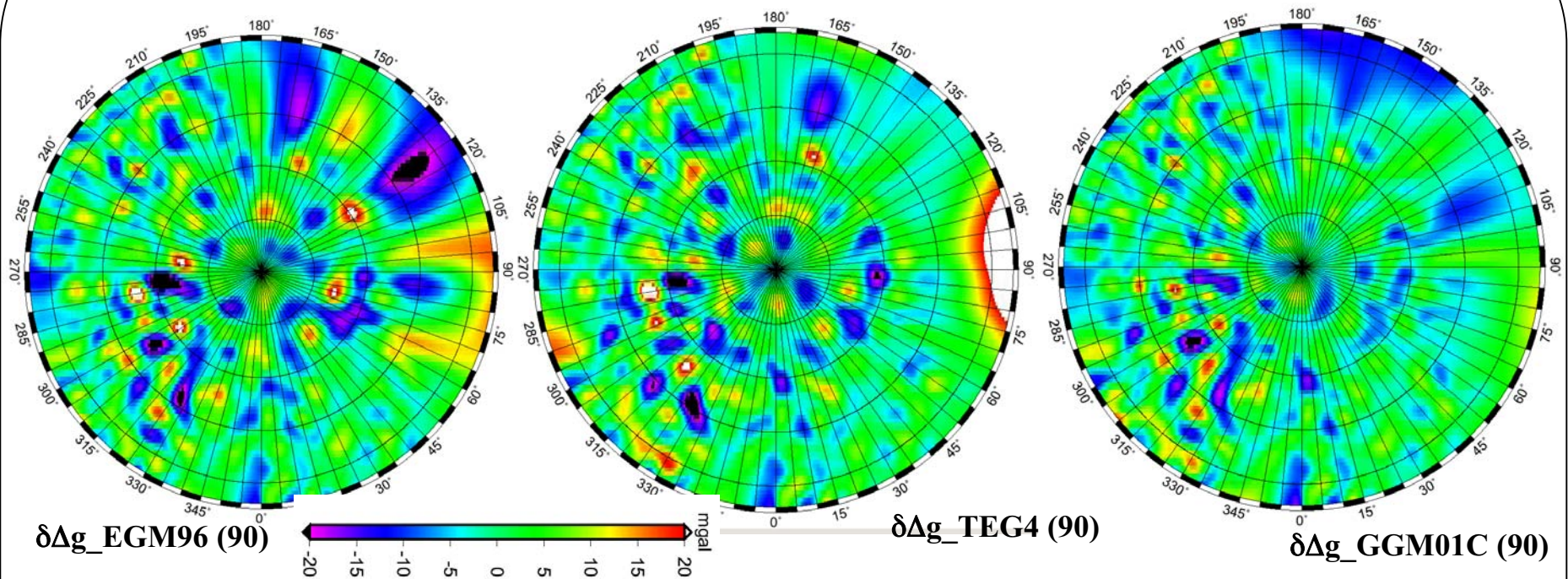

Gravity models	Nmax=90, radius = 222km		Nmax=120, radius = 166km	
	mean [mgal]	s.d. [mgal]	mean [mgal]	s.d. [mgal]
EGM96 (combination)	0.067	7.205	0.027	9.025
TEG4 (comb. + CHAMP)	-0.012	7.050	-0.047	8.782
GGM01C (comb. + GRACE)	-0.070	6.041	-0.125	6.788
GGM01S (GRACE-only)	-0.071	6.050	-0.132	7.159
GRACE01S (GRACE-only)	-0.063	6.037	-0.099	7.533



Regional gravity recovery (Downward continuation)

- Poisson's integral – space domain approach, data base (geoid grids)

$$T_{12}(r_1, \hat{e}_1, \hat{e}_1, r_2, \hat{e}_2, \hat{e}_2) = \frac{1}{4\pi R} \sum_{i=1}^N \left(\frac{(r_2^2 - R^2) \ddot{\Delta} \hat{o}_i}{l_{i,2}^3} - \frac{(r_1^2 - R^2) \ddot{\Delta} \hat{o}_i}{l_{i,1}^3} \right) \cdot T(R, \hat{e}_i, \hat{e}_i)$$

Observable: GRACE Level1B data

Kernel function: known from geometry

Unknown: Disturbing potential on the geoid

- Spherical CAP harmonics (SCH) – spectral domain approach, coefficients of each spectral component

$$T_{12}(r_1, \hat{e}_1, \hat{e}_1, r_2, \hat{e}_2, \hat{e}_2) = \frac{GM}{R} \sum_{k=2}^{\infty} \sum_{m=0}^{l(k)} \left\{ \begin{aligned} & \left[\left(\frac{R}{r_1} \right)^{l(k)+1} \bar{P}_{l(k),m}(\cos \hat{e}_1) \cos m \hat{e}_1 - \left(\frac{R}{r_2} \right)^{l(k)+1} \bar{P}_{l(k),m}(\cos \hat{e}_2) \cos m \hat{e}_2 \right] \bar{G}_{l(k),m} + \\ & \left[\left(\frac{R}{r_1} \right)^{l(k)+1} \bar{P}_{l(k),m}(\cos \hat{e}_1) \sin m \hat{e}_1 - \left(\frac{R}{r_2} \right)^{l(k)+1} \bar{P}_{l(k),m}(\cos \hat{e}_2) \sin m \hat{e}_2 \right] \bar{H}_{l(k),m} \end{aligned} \right\}$$

Unknown: SCH coefficients

SCH basis function: known from geometry

Fully normalized Legendre function with real degree $l(k)$ and integer order m



Temporal gravity field from GRACE: local hydrology recovery

(Left) Recovery through **regional** downward continuation (RMS of diff. = 5.5cm)

(Middle) True continental surface water mass change (NCEP; July, 2001 with respect to Jan., 2001)

(Right) Recovery through **global** spherical harmonic analysis (RMS of diff. = 8.0cm)

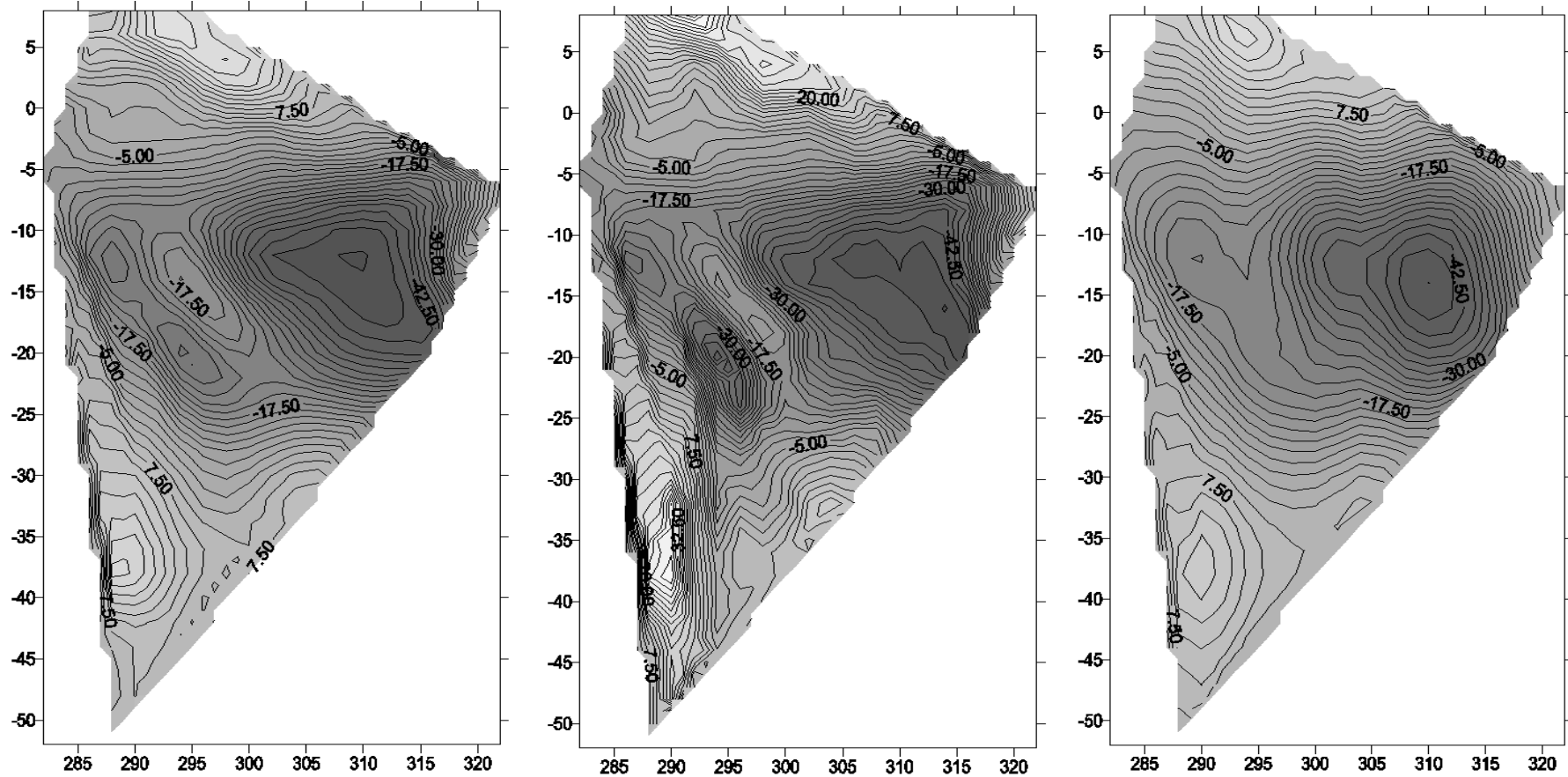

Local power spectral density (PSD)

⇒ Local power spectra were computed using three regional maps and compared.

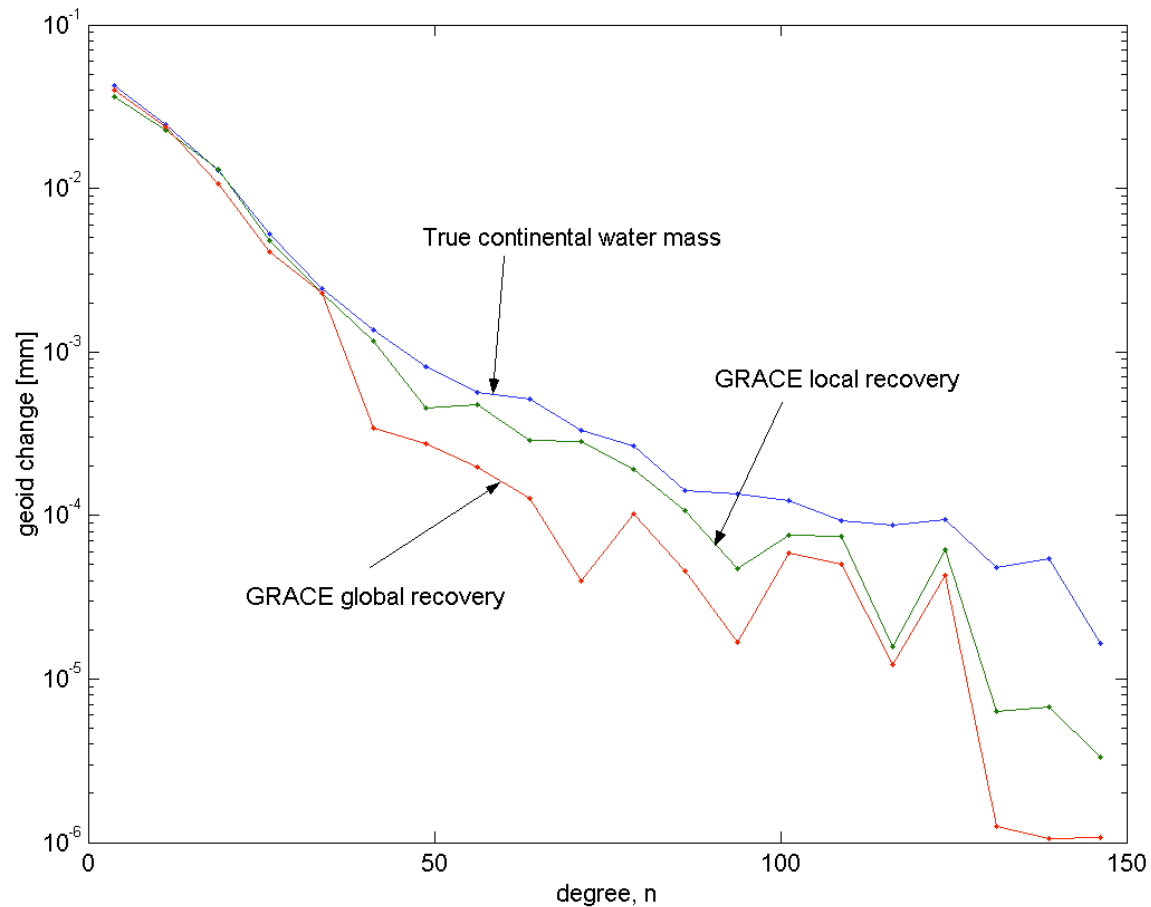

Note: Local method may enhance the accuracy as well as the (spatial) resolution.



Validation of GRACE Data Products: Characterization of Roles of Ice Sheet and Oceanic Mass Variations in Global Sea level Change

C.K. Shum^{1,2}, Alexander Braun^{2,1}, Shin-Chan Han¹,
Christopher Jekeli¹, Reinhard Dietrich³, Andy Trupin⁴

¹Laboratory For Space Geodesy, Ohio State Univ

²Byrd Polar Research Center, Ohio State Univ

³Technische Universität Dresden

⁴Oregon Institute of Technology

GRACE Science Meeting

Austin, Texas

8-10 October 2003

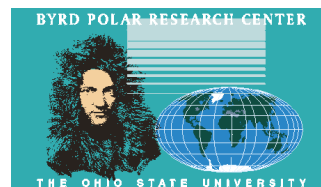
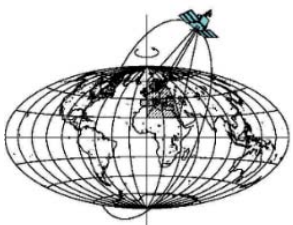
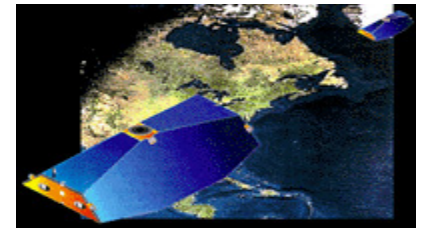
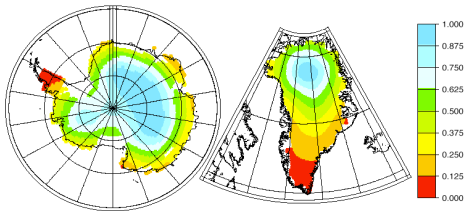

Validation of GRACE Data Products: Ice Sheet and Oceanic Mass Variations

Objectives:

- GRACE data product validation on Dronning Maud Land, East Antarctica, “blue-ice” region (100x50 km², south of Schirmacheroase glacier) (TU Dresden)
- Use of GRACE *in situ* disturbance potential data types to validate various corrections (tides, atmosphere)
- Improve atmosphere pressure over Antarctica using finer-resolution model (Antartica Mesoscale Prediction System, UCAR/OSU) and GPS occultation data for ice sheet mass balance studies
- Study contribution of Southern Ocean mass variation to global sea level rise



TU Dresden GRACE/ICESAT/CRYOSAT Ca/VaI Site

Dronning Maud Land

Thinning at ~15 cm/yr

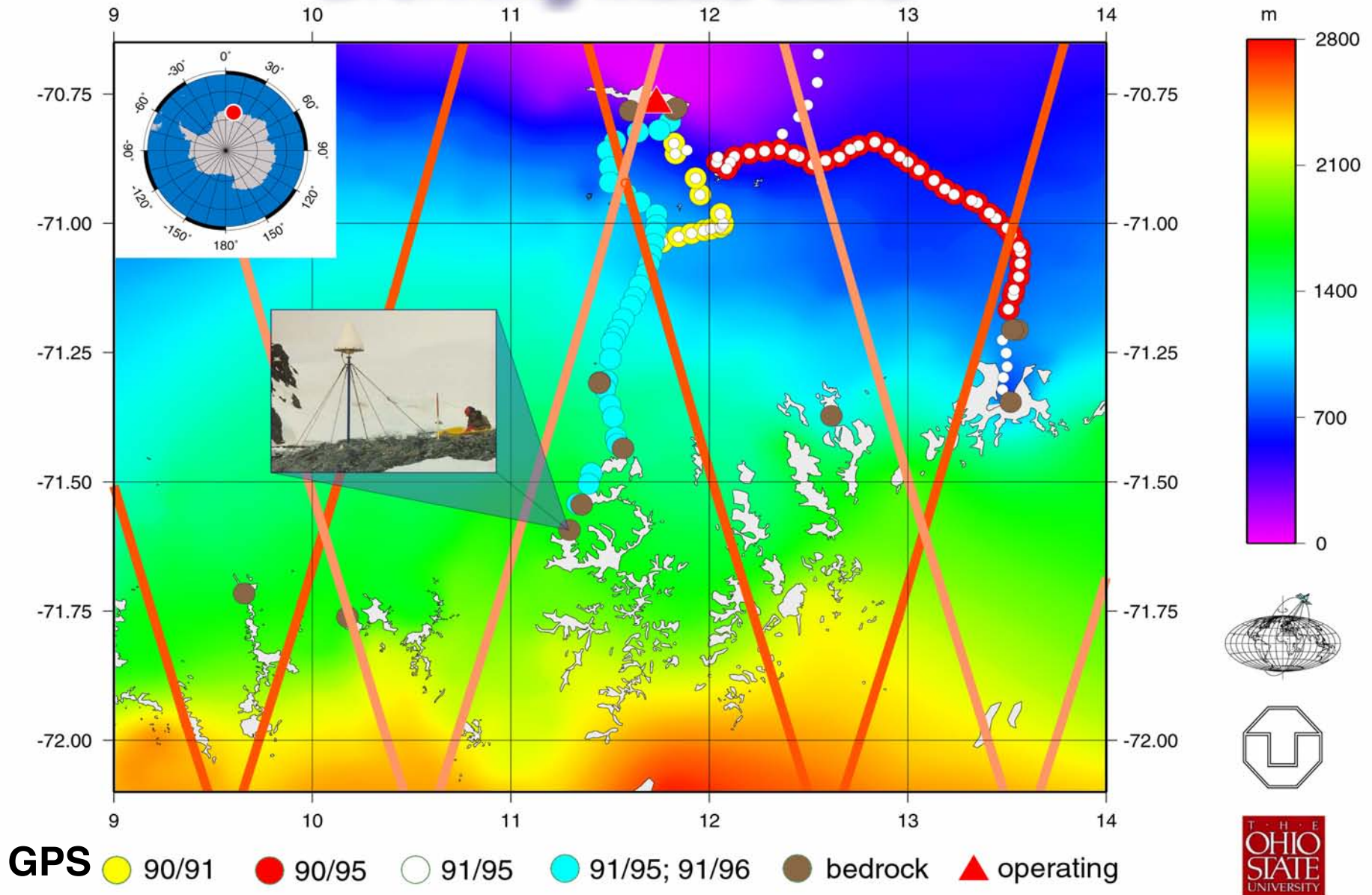

Effect of ocean tide model error on GRACE one month measurements

- The temporal aliasing tide errors computed along GRACE orbit for 30 days in terms of the range-rate; (left-top) K_1 , (right-top) O_1 , (left-bottom) M_2 , and (right-bottom) S_2 .

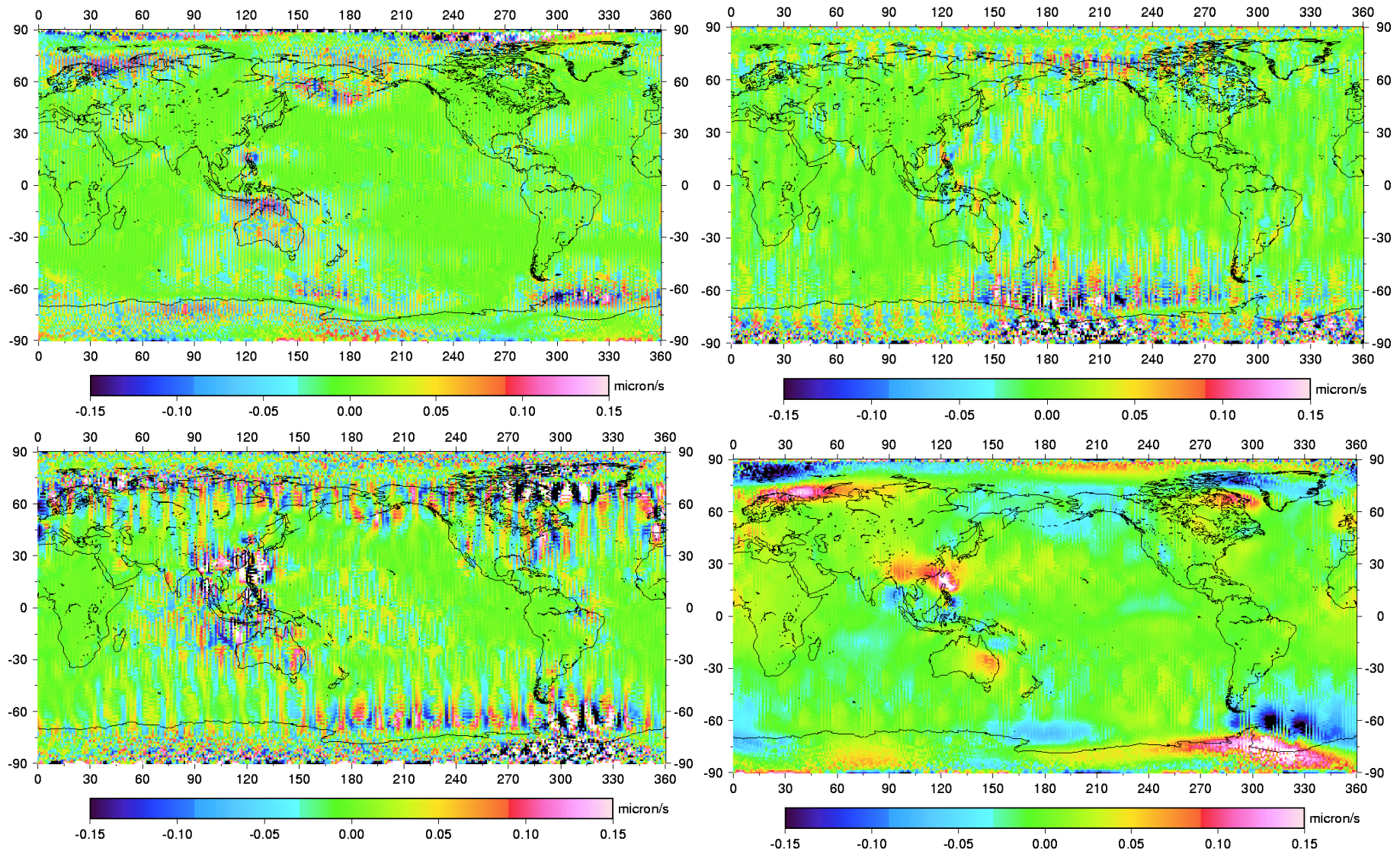

Han, Shum and Jekeli, in review, JGR, 2003

Effect of ocean tide model error on GRACE one month measurements

- The temporal aliasing tide errors (after Gaussian smoothing with radius of 800km); (left-top) K_1 , (right-top) O_1 , (left-bottom) M_2 , and (right-bottom) S_2 .

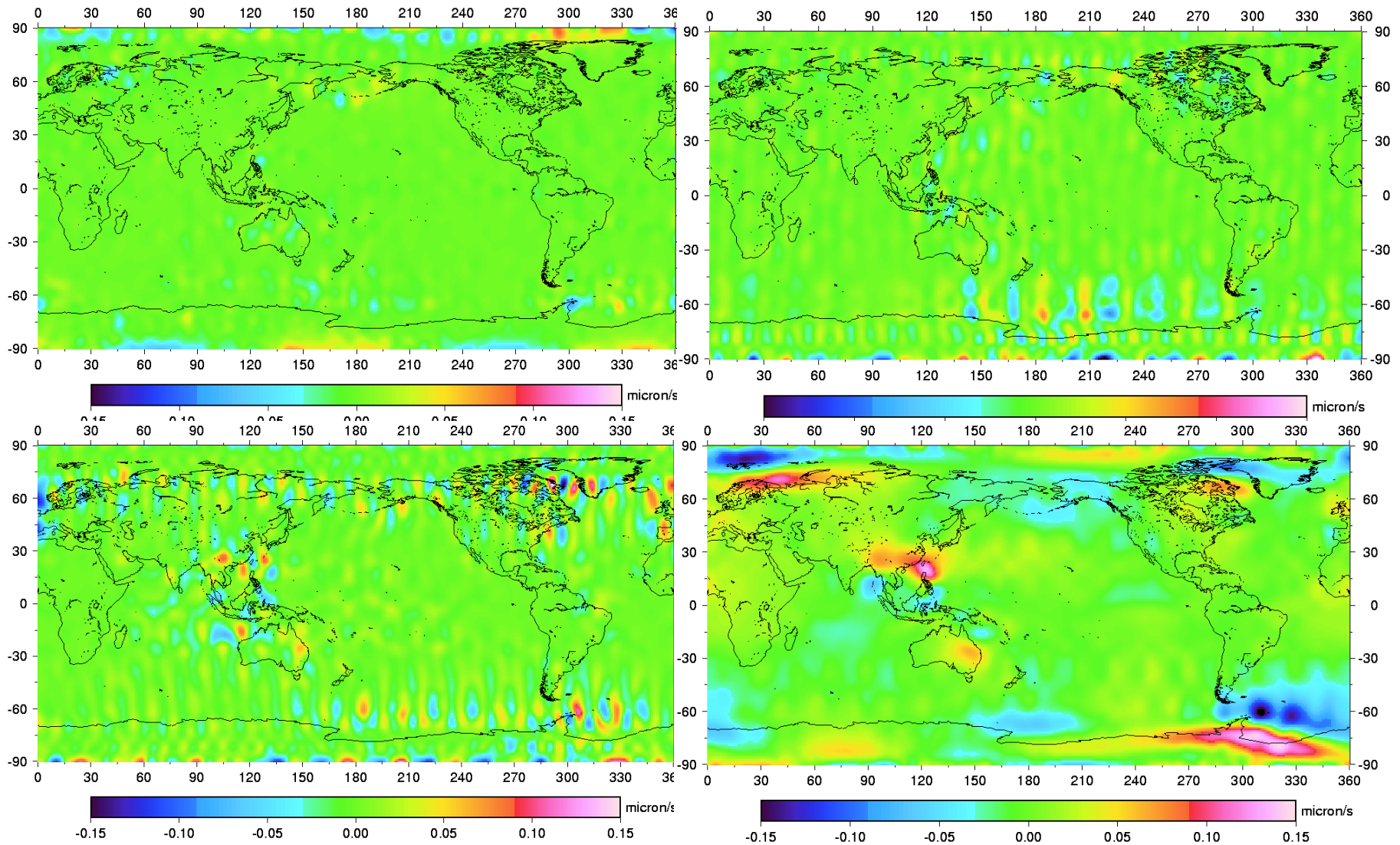

EFFECT OF OCEAN TIDE MODEL ERROR ON MONTHLY MEAN GRACE GRAVITY FIELD

Ratio between tidal model error and measurement noise in recovered coefficients

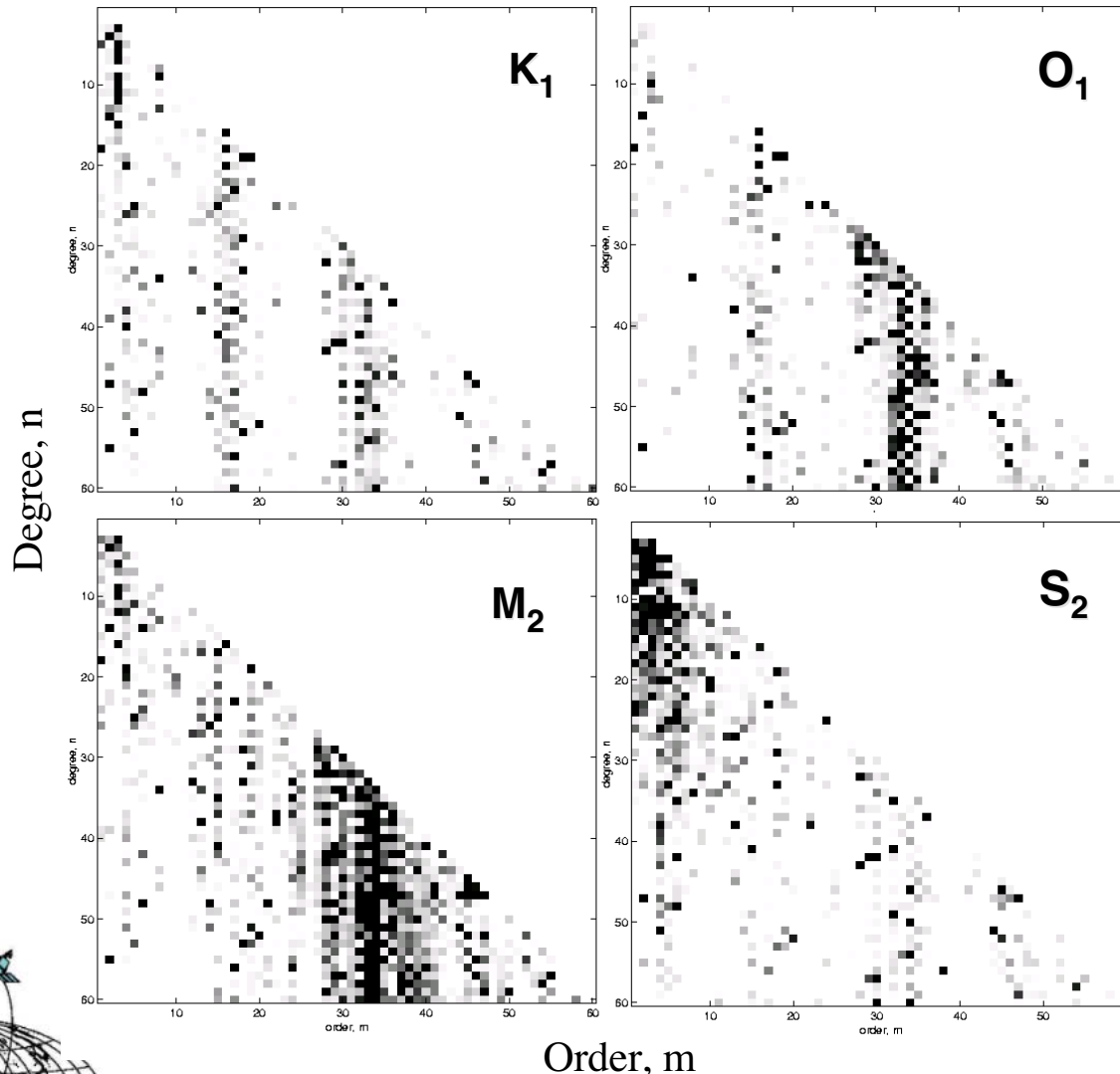

K₁, O₁, and M₂ errors are not sampled in-phase, which produce sectorial anomaly over a globe and corrupts coefficients corresponding to certain order and entire degrees

S₂ error significantly corrupts the temporal gravity estimates, because of aliasing period longer than one month (it does not averaged out in a month)



Black dots indicate that recovered ocean tide constituent errors are larger than measurement noise

'Truth' geoid change (left-top); Recovered geoid change (right-top); Effect of noise and atmosphere aliasing (left-bottom); Aliasing effect only (right-bottom)

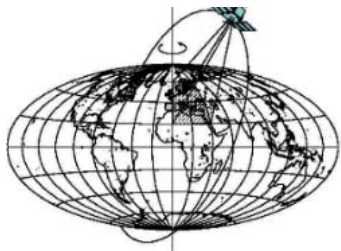
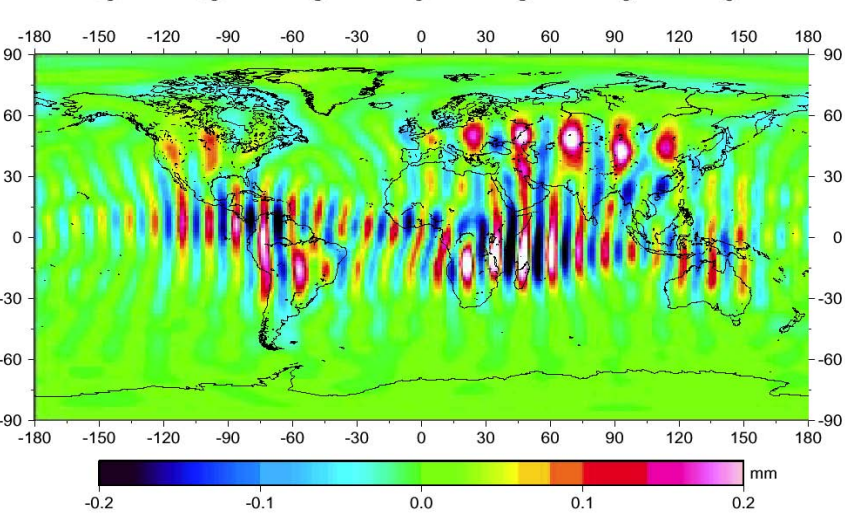
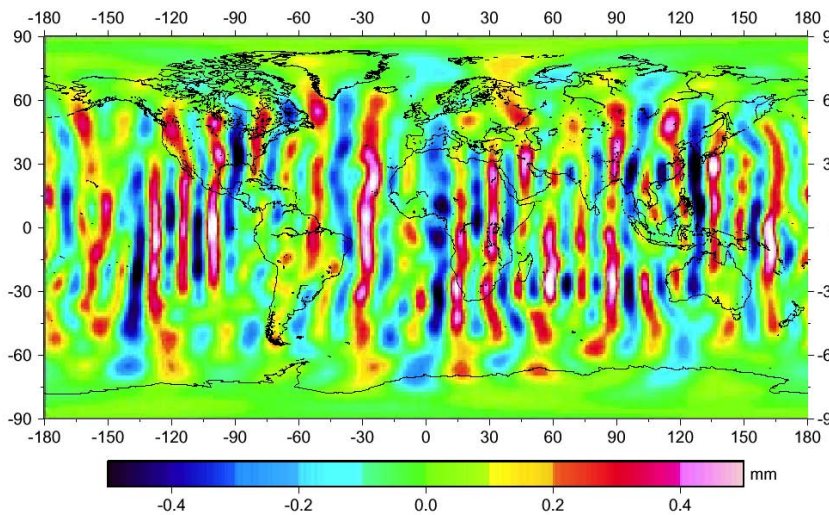
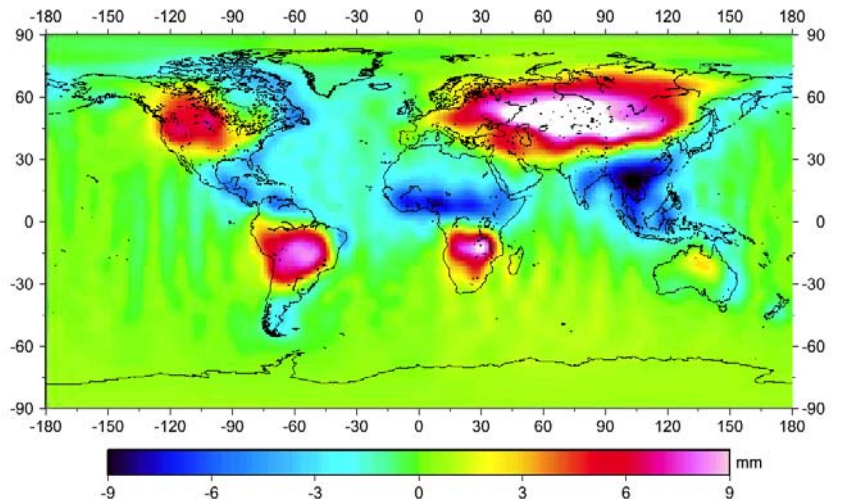
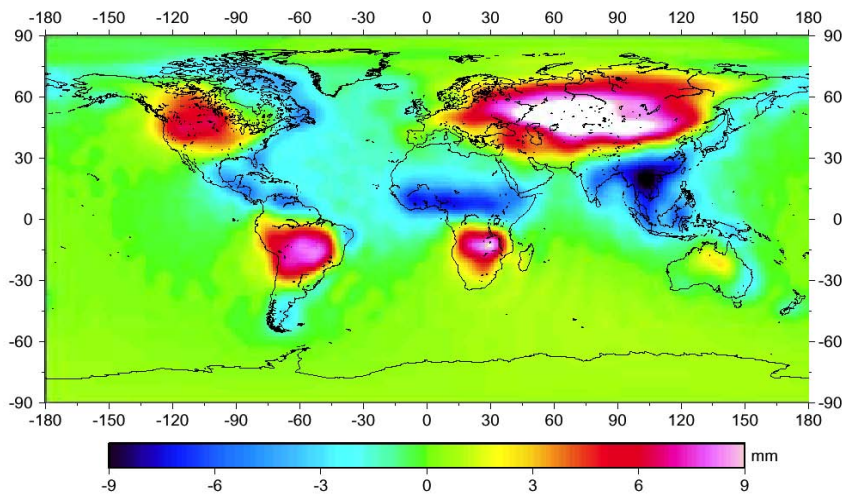

GRACE Simulation: effect on hydrological signal recovery

Han, Shum and Jekeli, in review, JGR, 2003



GRACE Simulation to Recover Glacial Isostatic Rebound

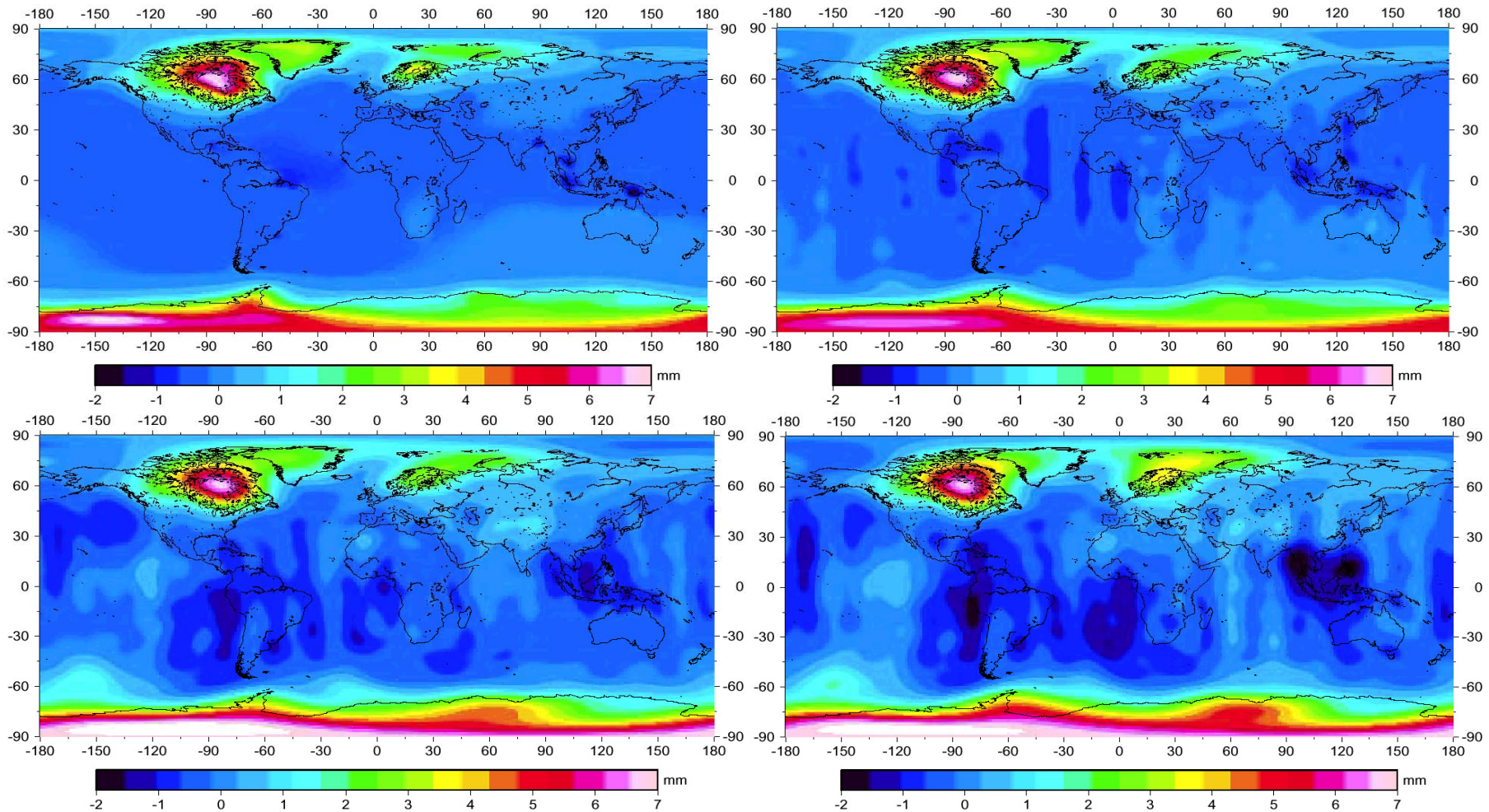

Top left: 5 years of ICE-4G GIA signal; Top right: GRACE recovered of GIA (noise only); Bottom left: recovery in the presence of atmospheric error and noise; Bottom right: recovery in the presence of noise, atmospheric and tide errors



CHAMP Occultation Measurements

13,422 profiles

Jan-Mar, 2003 #2246

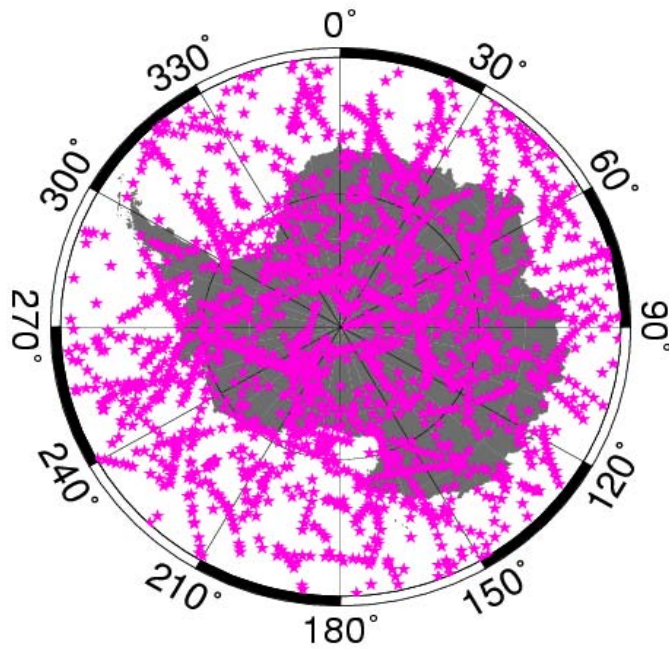

CHAMP profile location

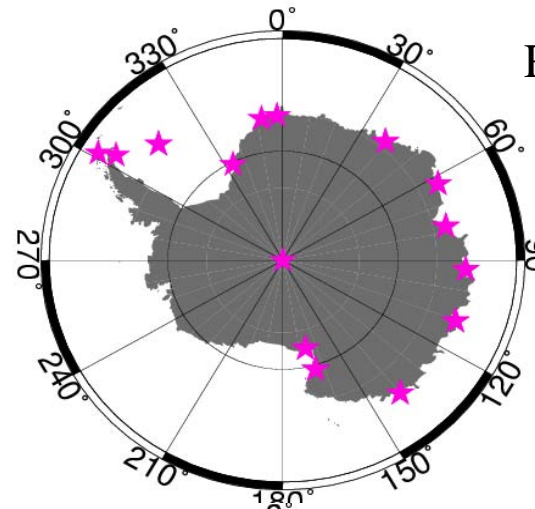

Radiosonde location

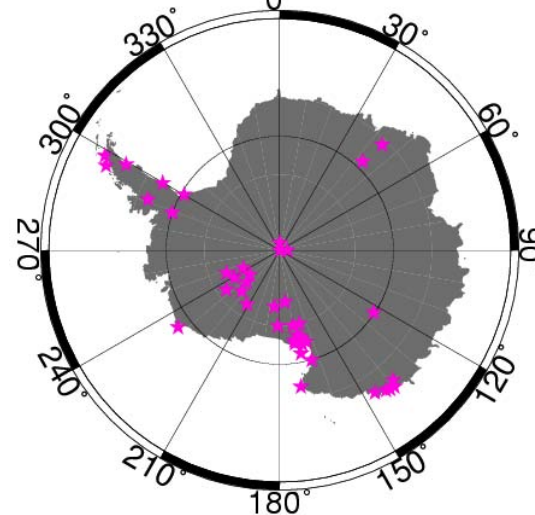

Automatic Weather Station Location



ECMWF vs AWS (45 stations): >5 mb mean, >2 mb rms, much worse than differences in the US and Arabian regions studied by Velicogna & Wahr [2002]



GLOBAL COMPARISONS OF ECMWF AND CHAMP OCCULTATION PROFILES (Jan-March, 2003, 13,422 profiles)

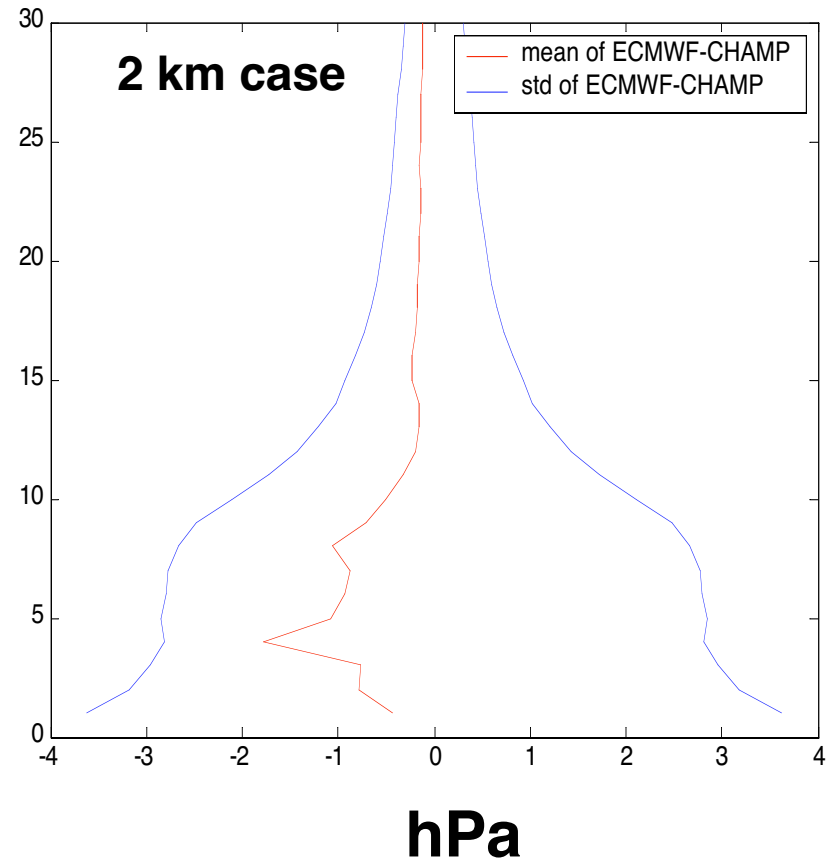
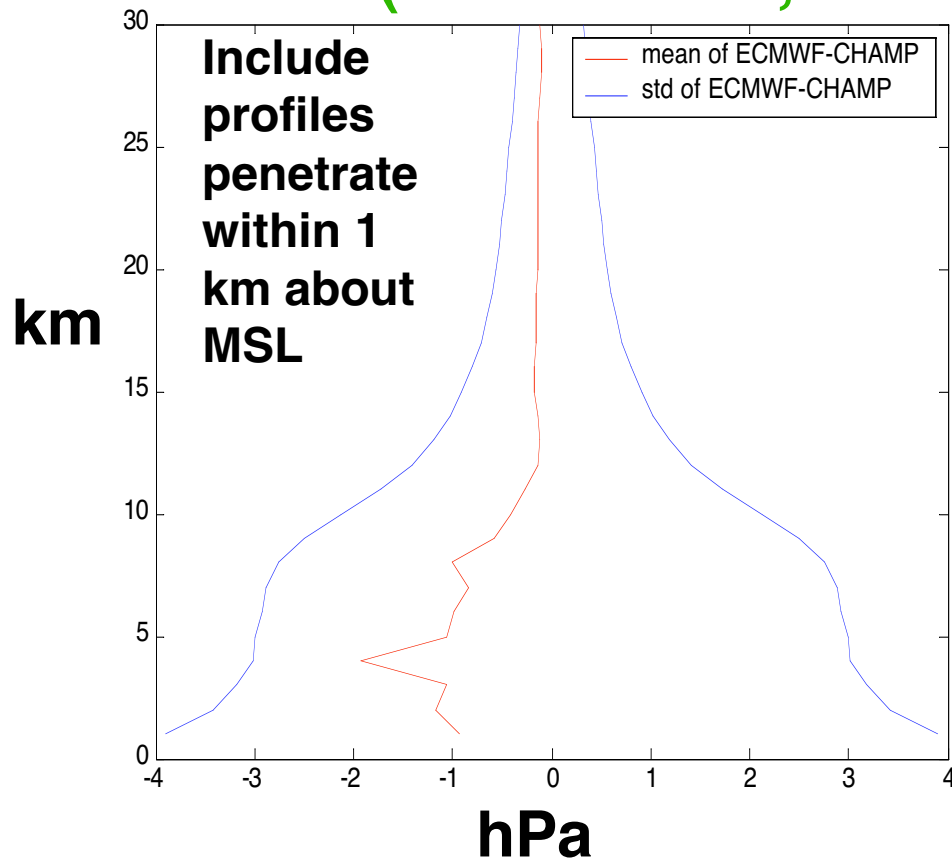

CHAMP radar penetration over Antarctica mostly (~80% vs 10% in equatorial region) within 1 km primarily because of lack of water vapor



Short and Long-term Stability of the GRACE Ultra Stable Oscillators (USO)

Kristine M. Larson
Department of Aerospace Engineering Sciences
University of Colorado, Boulder

Questions:

1. How stable are the USO's? Do they behave consistently with respect to each other? How are they impacted by temperature, radiation, and acceleration? How does the accuracy of the USO affect GRACE data products?
2. How stable is the time and frequency behavior of the transfer system, i.e. the GPS system itself? Which parts of the GPS system have the greatest influence and how can they be improved for future NASA missions (e.g. GRACE Follow-On and PARCS).

Master Clock–Alternate Master Clock

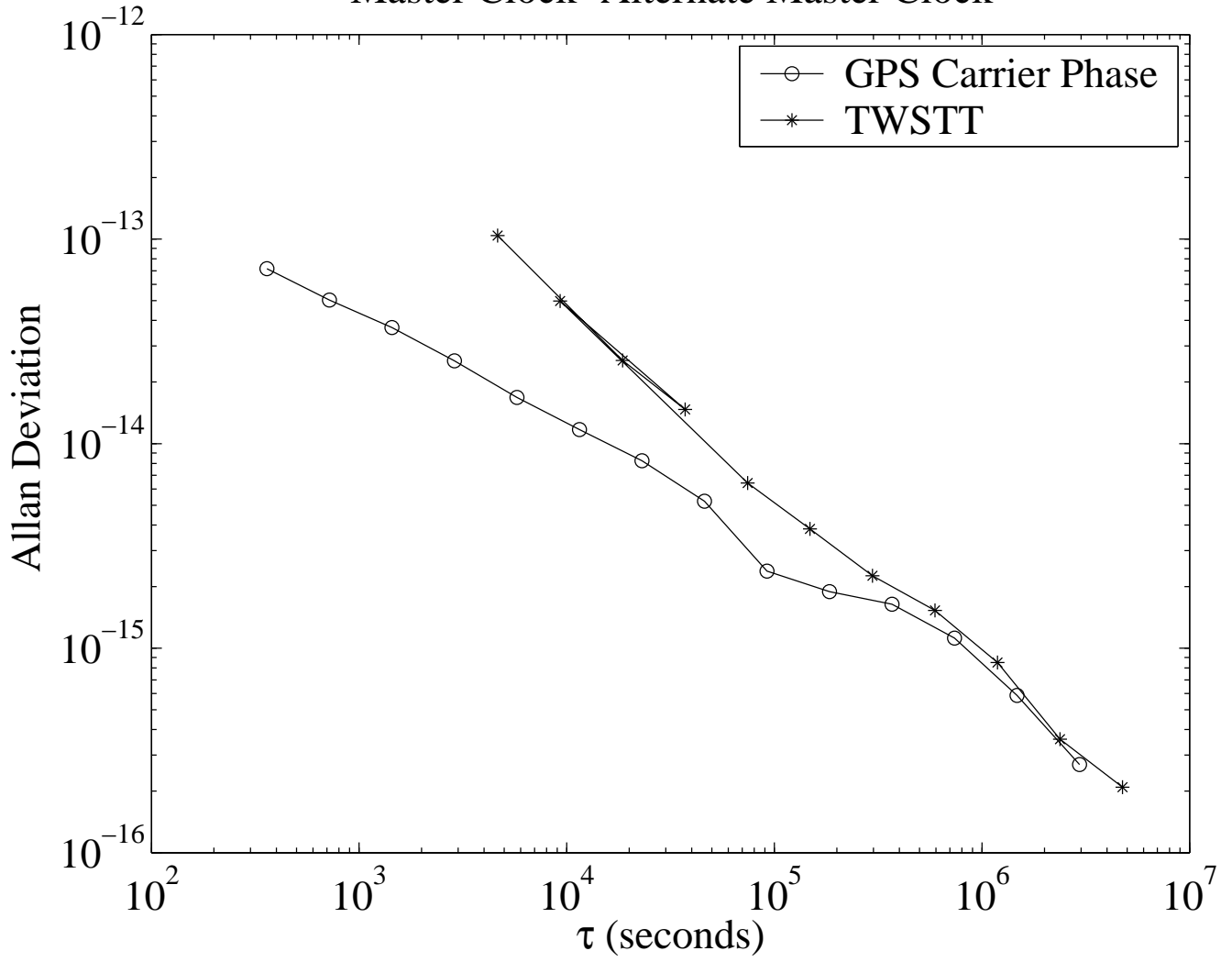

Topex Clock

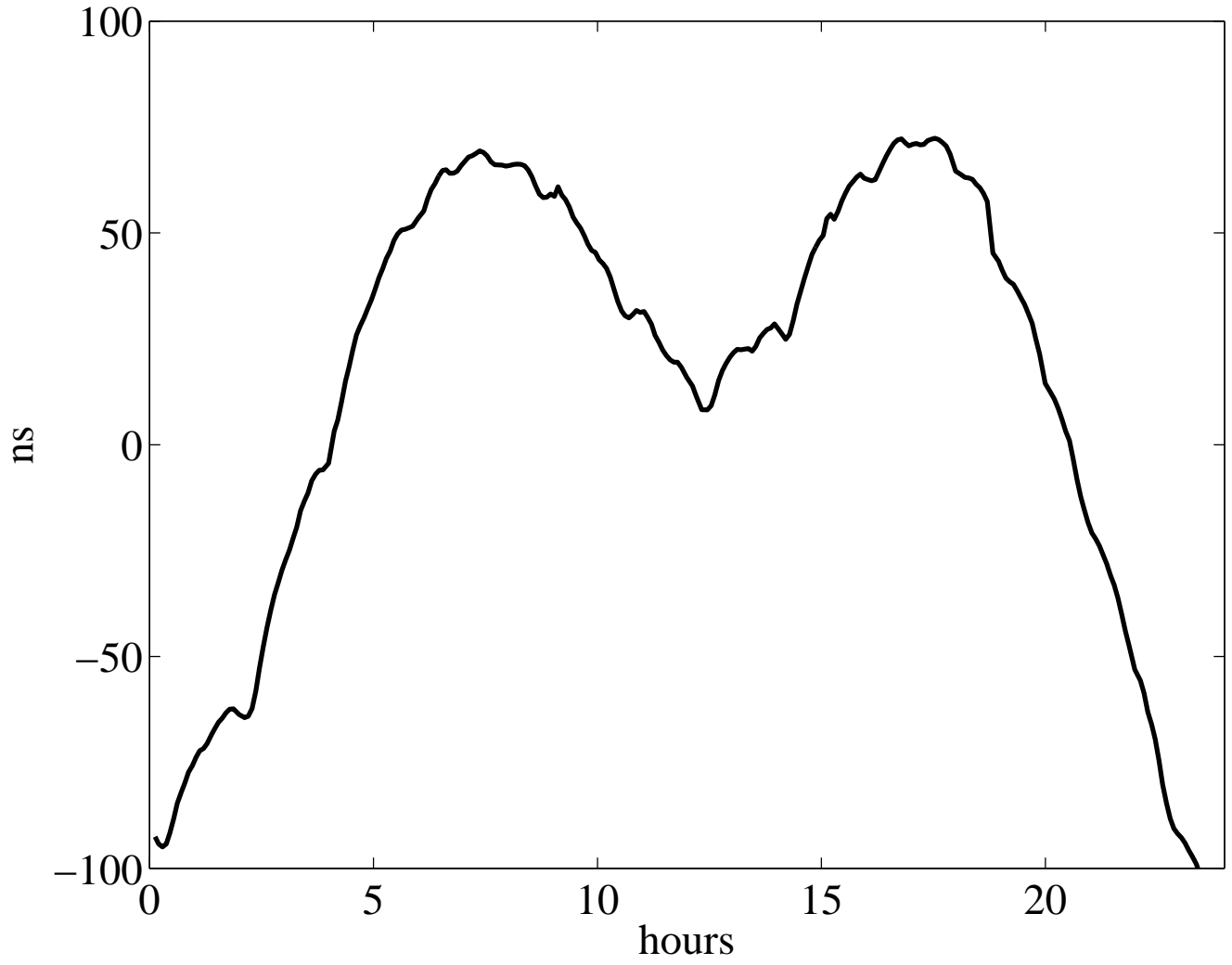

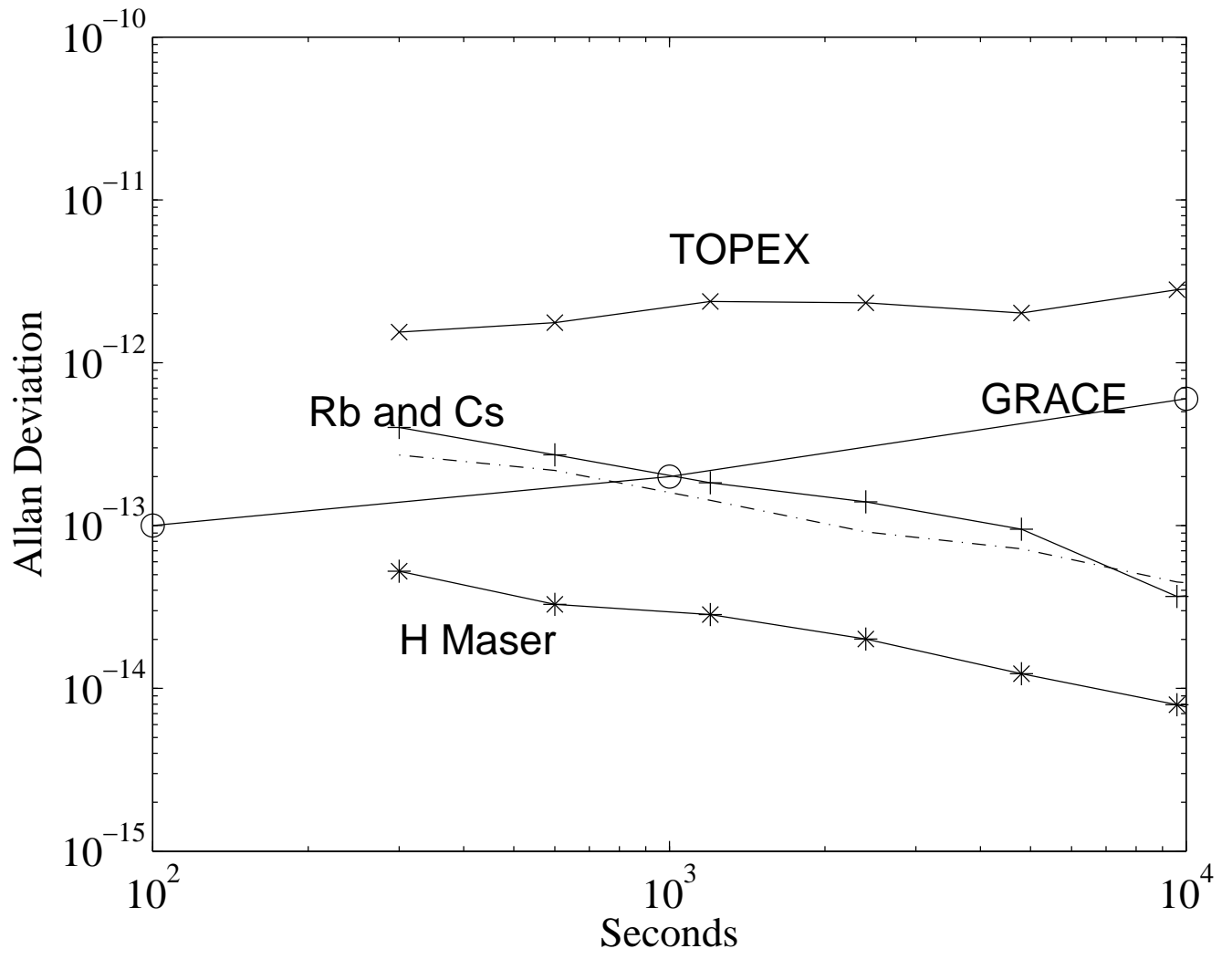

GRACE, Mass Displacements, and the Earth's Rotation

by

Richard S. Gross

Jet Propulsion Laboratory
California Institute of Technology
Pasadena, CA 91109-8099, USA

GRACE Science Team Meeting

October 8-10, 2003
University of Texas at Austin
Center for Space Research

- Investigate gravitational and rotational response of Earth to mass displacements
 - Atmosphere, oceans, hydrology, cryosphere
 - Earthquakes
- Validate GRACE measurements of time varying gravitational field
 - Earth rotation measurements (degree-2)
 - GPS-derived surficial mass loads (degrees 1-6)
- Investigate excitation of Chandler wobble
 - GRACE measurements of mass change
 - Models of atmospheric, oceanic, & hydrologic mass motion
- Constrain frequency dependence of mantle anelasticity
 - Improve estimates of period and Q of Chandler wobble

MASS LOADS FROM GPS

- **Surficial mass loads cause large-scale changes in shape of Earth**
 - Individual GPS receiver can measure change in height of station
 - Global network of GPS receivers can measure large-scale changes in Earth's shape
- **Use GPS-estimated change in shape of Earth to infer the mass load causing Earth's shape to change**
 - Blewitt *et al.* (2001); Blewitt and Clarke (2003)
- **Mass load also causes Earth rotation and gravitational field changes**
 - Changes in Earth's shape, rotation, and gravitational field due to same underlying process must be consistent with each other
 - Use independent measurements of changes in Earth's shape and rotation to validate GRACE time varying gravitational field measurements
- **Illustrate use of Earth rotation to validate GRACE measurements by using GPS-derived mass load harmonics as proxy GRACE measurements**

DATA SETS

- **Polar motion observations**
 - **COMB2002 combined Earth orientation series**
 - Kalman filter-based combination of optical astrometric, SLR, LLR, VLBI, and GPS measurements
 - Daily values at midnight spanning 1962–2002
 - **Kalman filter self-consistently estimates polar motion rate and hence polar motion excitation function**
- **Atmospheric angular momentum**
 - **NCEP/NCAR reanalysis atmospheric angular momentum series due to winds**
 - 6-hour values spanning 1948–present
 - **Convert to equivalent polar motion excitation functions**
- **Oceanic angular momentum**
 - **ECCO data assimilative oceanic angular momentum series due to currents**
 - Hourly values spanning 1993–2002
 - **Convert to equivalent polar motion excitation functions**
- **GPS-derived mass load**
 - **Inferred from GPS estimates of large-scale change in Earth's shape (Blewitt *et al.*, personal communication, 2003)**
 - Weekly values spanning 1995.7–2001.1
 - **Convert to equivalent polar motion excitation functions**

APPROACH

- **Polar motion excitation**
 - **Remove long-period ocean tidal effects**
 - Empirical model of Gross *et al.* (1998)
 - **Remove motion effects**
 - Wind effects using NCEP/NCAR reanalysis
 - Current effects using ECCO data assimilative model
 - **Remove signals with periods longer than span of GPS-derived mass load**
 - High-pass filter with cutoff period of 5 years
 - **Form weekly averages**
 - **Linearly interpolate to epochs of GPS mass load series**
- **GPS-derived mass load**
 - **Compute effect on polar motion excitation of second-degree mass load coefficients**
 - Mass load changes Earth's inertia tensor and hence rotation
 - **Convert to equivalent polar motion excitation functions**
- **Compare polar motion excitation observations, from which tidal and motion effects have been removed, to excitation predicted by GPS-derived mass load**

POLAR MOTION EXCITATION

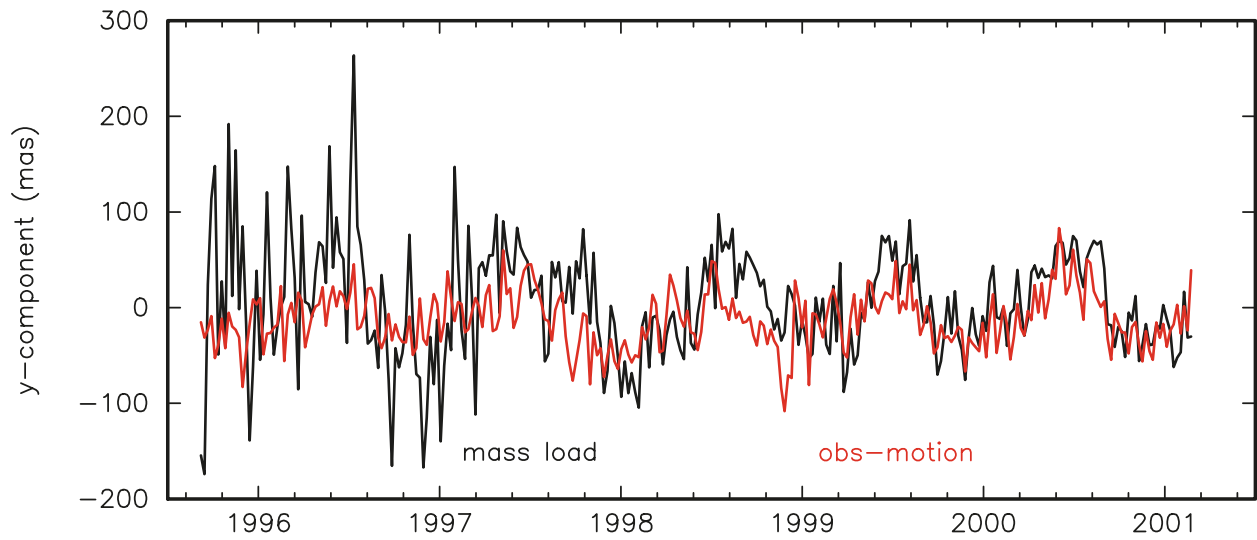
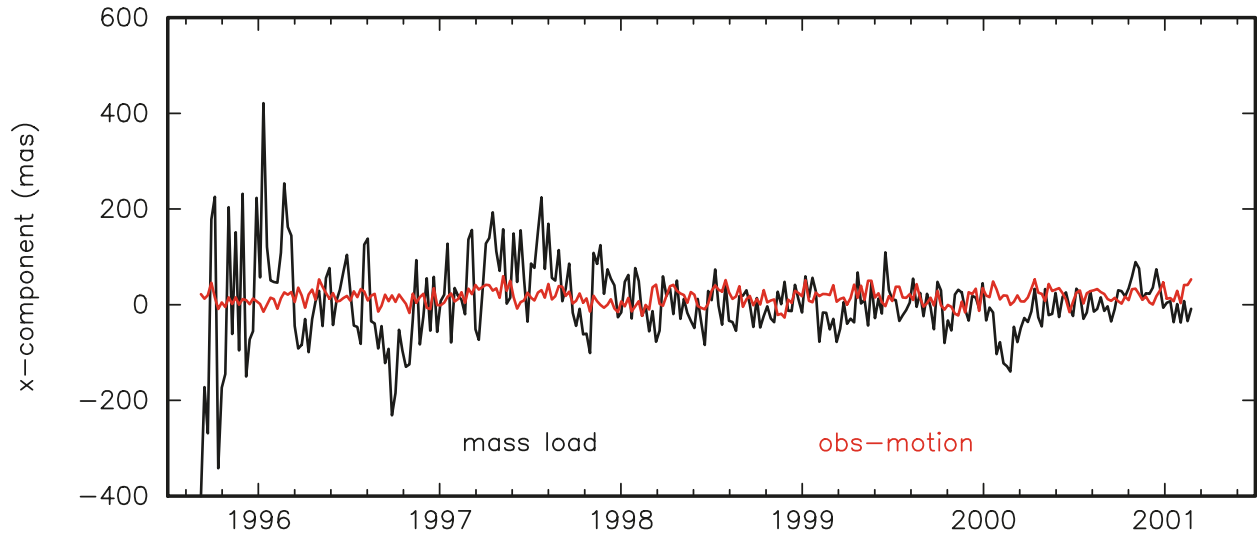

GRACE Validation Using Earth Rotation & Climate Models

Investigators: Jianli Chen, Clark Wilson
Center for Space Research, University of Texas at Austin

Main Objectives:

- ✦ **To determine low degree gravitational changes from the Earth's rotational observations (X,Y, LOD), atmospheric, oceanic, and hydrological models.**
- ✦ **To validate low degree GRACE measurements using Earth rotation-derived estimates and model predictions.**
- ✦ **To study high frequency variations of low degree gravitational changes and assess potential aliasing effects in the monthly GRACE solution.**
- ✦ **To strengthen the overall time-variable gravity solution from GRACE.**

Major tasks:

- ✦ To estimate polar motion and LOD excitation functions (Ψ_1, Ψ_2, Ψ_3) using Earth Orientation Parameters (EOP), X, Y, and LOD (e.g., SPACE2002, IERS Combination).
- ✦ To assess wind contributions to atmospheric angular momentum (AAM) using NCEP and ECMWF atmospheric models. These effects contribute to polar motion and LOD excitations (Ψ_1, Ψ_2, Ψ_3) and must be removed before the residual excitations can be converted to Stokes Coefficient time series.
- ✦ To study ocean current effects on Ψ_1, Ψ_2 , and Ψ_3 using model estimates from the ECCO data assimilating OGCM (and other available models). Again, the motion contribution from the oceans must be removed before the residual can be interpreted as due to mass redistribution and corresponding gravity changes.
- ✦ To determine degree 2 gravitational variations, C_{21}, S_{21} , and C_{20} based on residual excitations of Ψ_1, Ψ_2 , and Ψ_3 , and to compare the results with GRACE observations (and model predictions and SLR measurement).
- ✦ To determine low degree gravity change using atmospheric (e.g., NCEP, ECMWF), oceanic (ECCO, others), and hydrological (e.g., CPC LDAS, NCEP) models, to compare the results with GRACE, SLR, and EOP derived solutions.
- ✦ To assess aliasing effects in C_{21}, S_{21} , and C_{20} and other low degree GRACE products, and to develop models for the variance and coherence spectrum of Stokes Coefficients at other harmonic degrees as a function of temporal frequency and/or time.

Basic Equations:

$$\psi_i^{obs} = \psi_i^{mass} + \psi_i^{motion}, \quad i = 1, 2, 3$$

$$\psi_i^{motion} = \psi_i^{winds} + \psi_i^{currents}$$

$$\psi_i^{mass} = \psi_i^{obs} - \psi_i^{winds} - \psi_i^{currents}$$

$$(\Delta C_{21}, \Delta S_{21}, \Delta C_{20}) = A_i * \psi_i^{mass}$$

Sample Results:

- ✦ **Observed Excitations:** SPACE2002 (X, Y, and LOD);
- ✦ **Wind Excitations:** NCEP AAM;
- ✦ **Current Excitations:** ECCO Data Assimilation OGCM
- ✦ **Model Predictions:** NCEP pressure, ECCO bottom pressure, LDAS land water

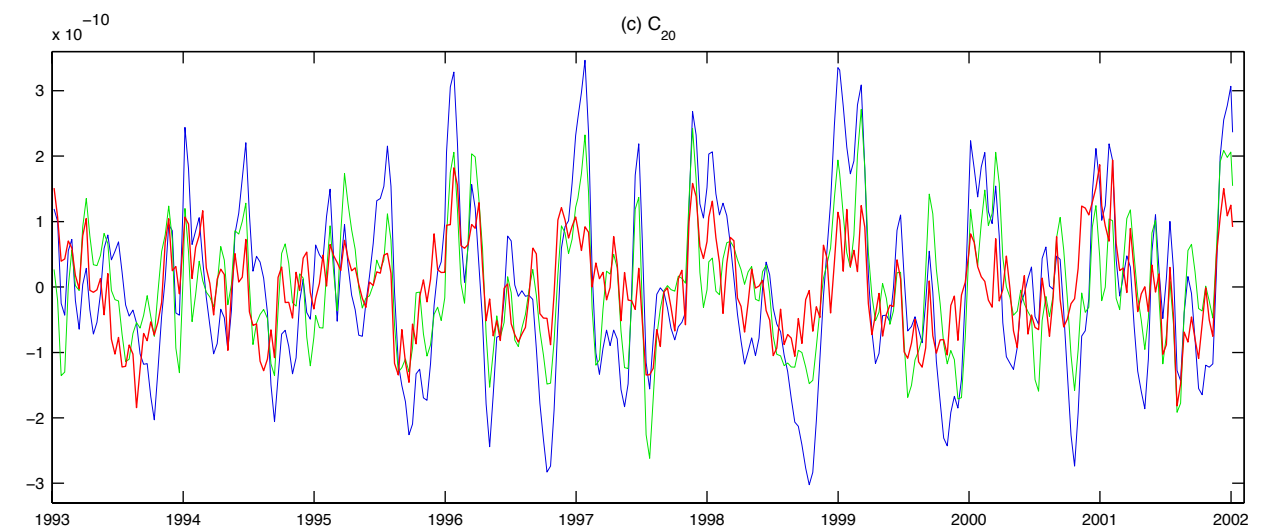
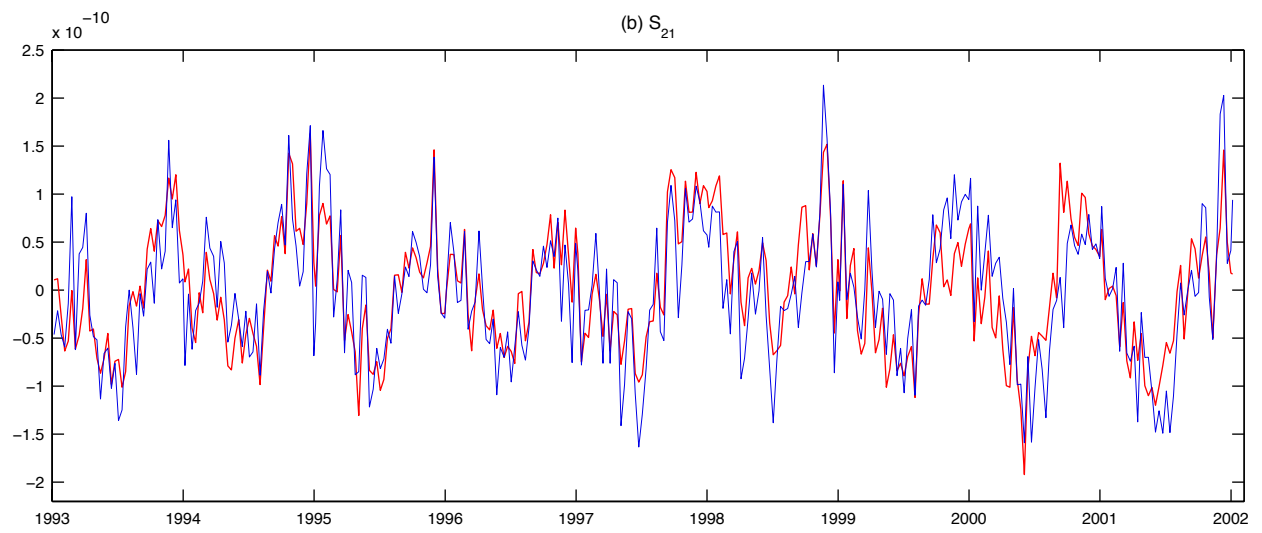
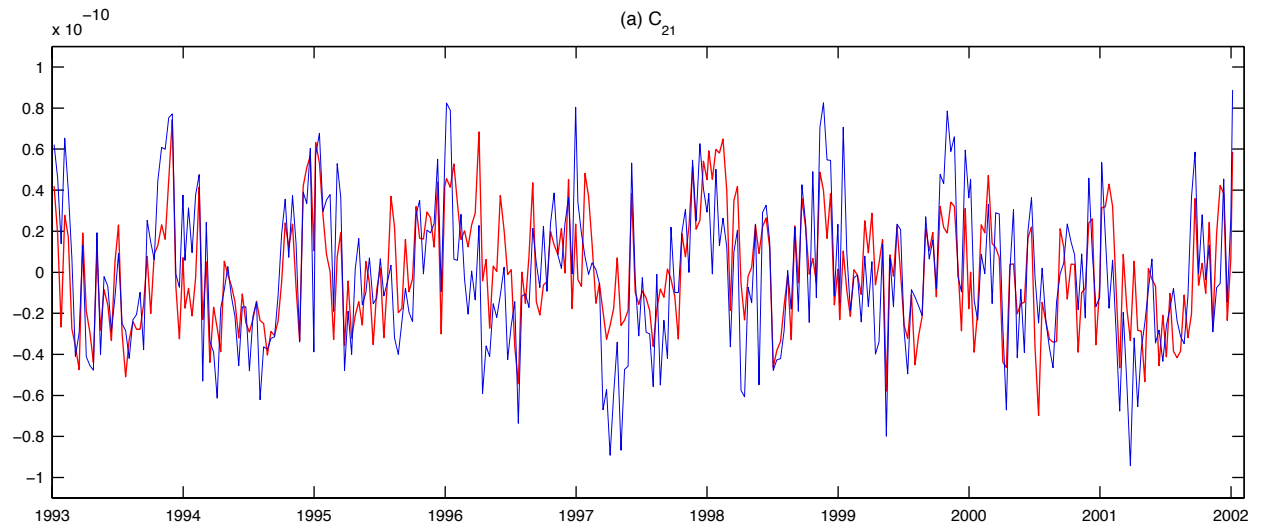

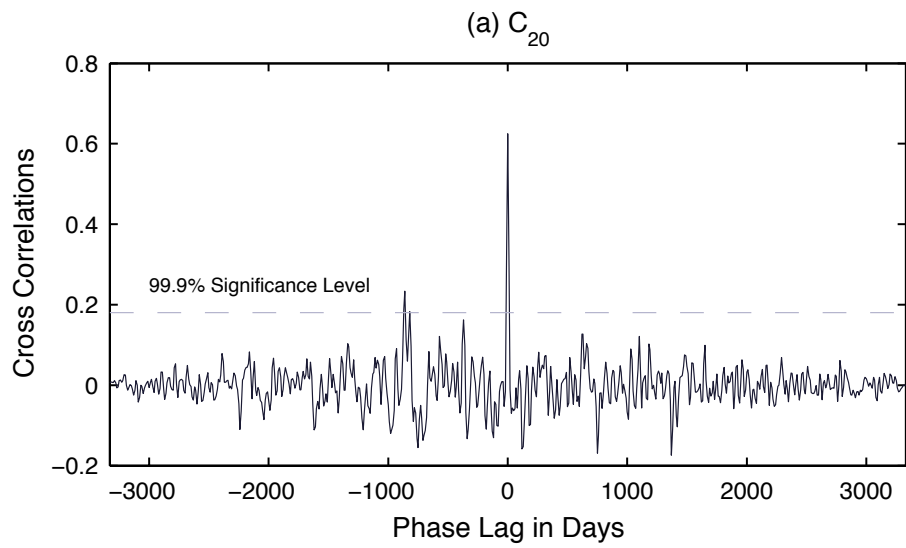
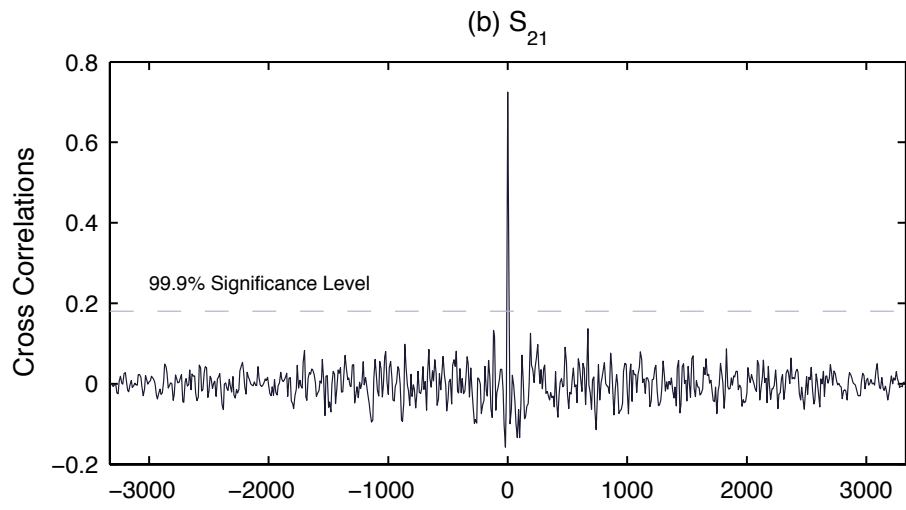
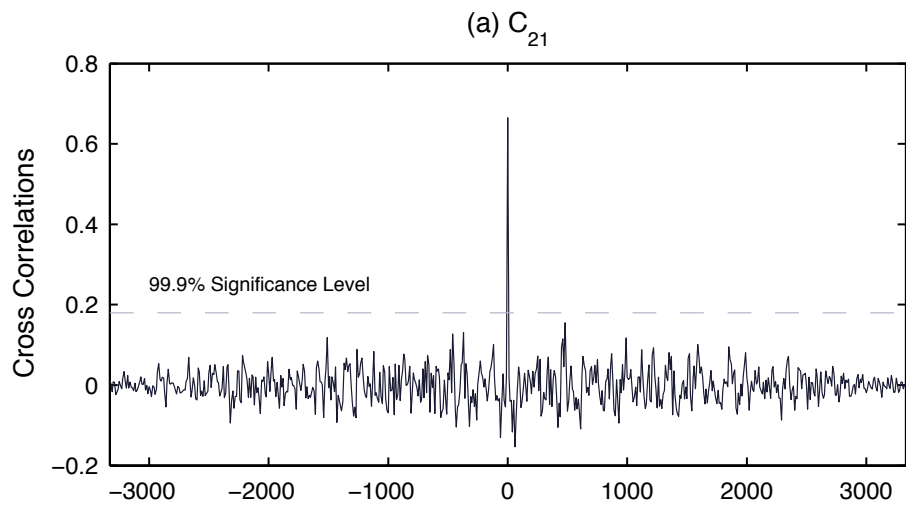

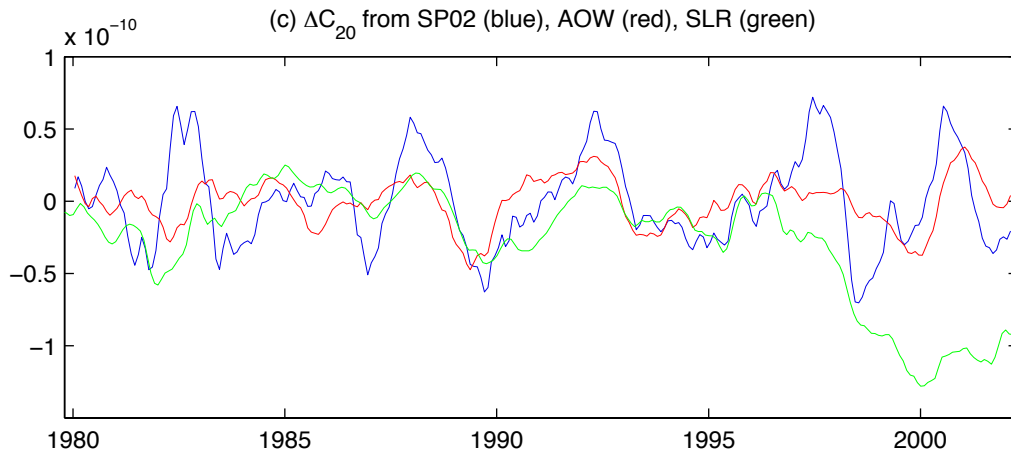
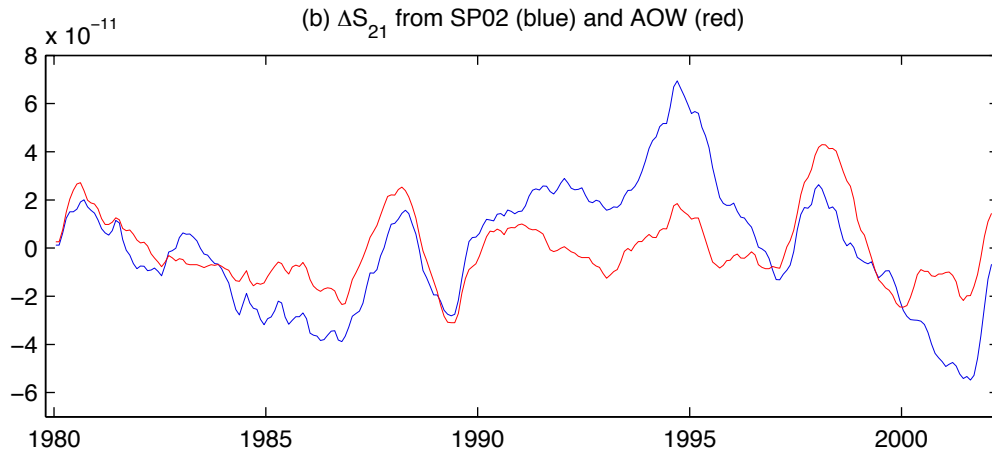
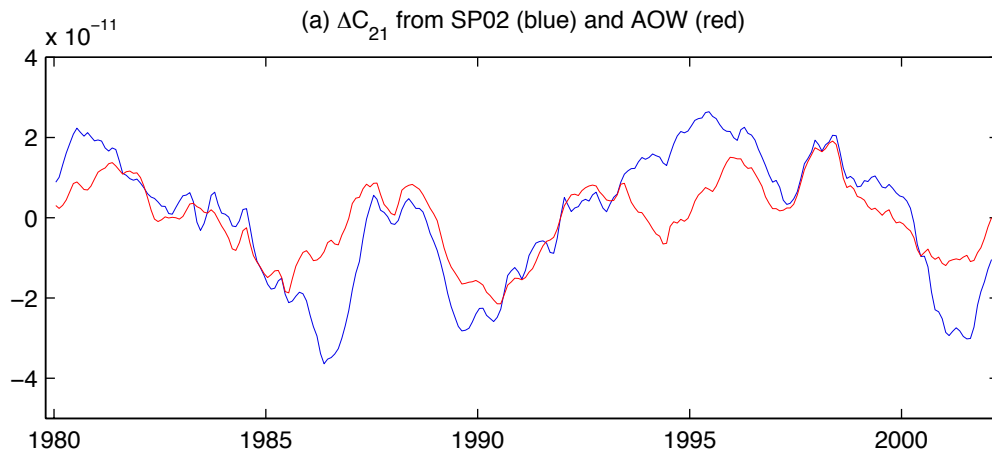

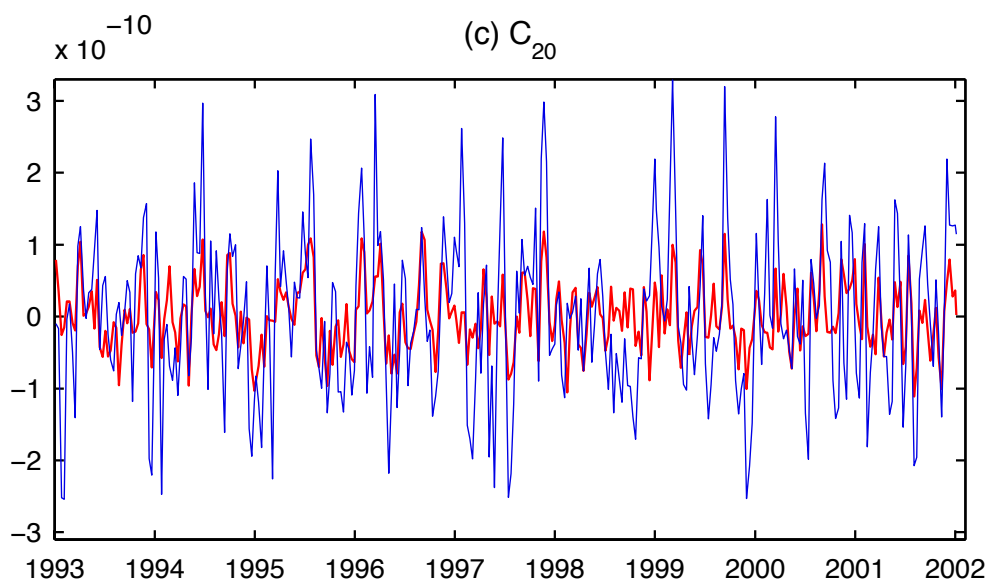
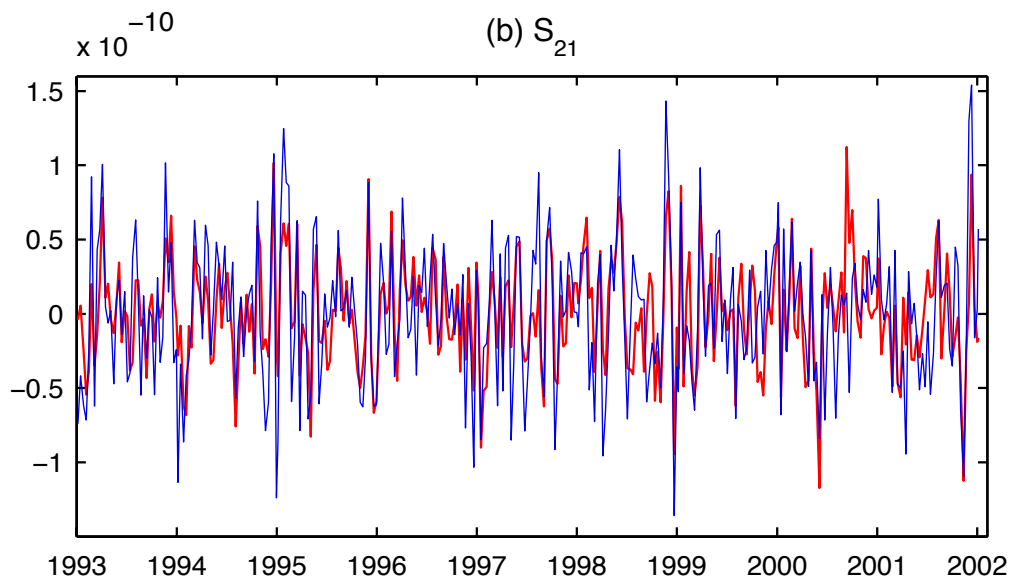
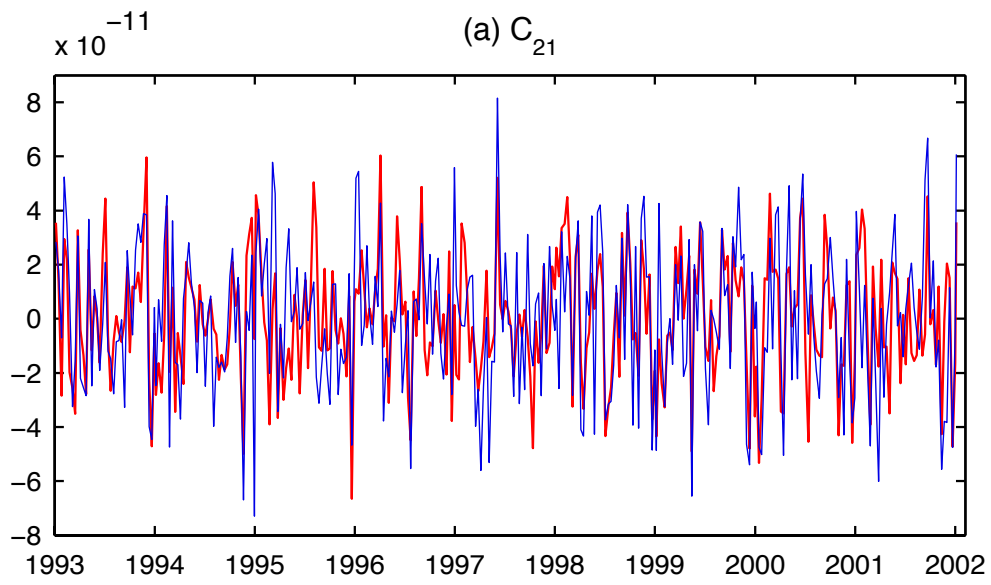

$\times 10^{-7}$ (a) ψ_1 from SP02 (blue), Winds (red), and Currents (green)

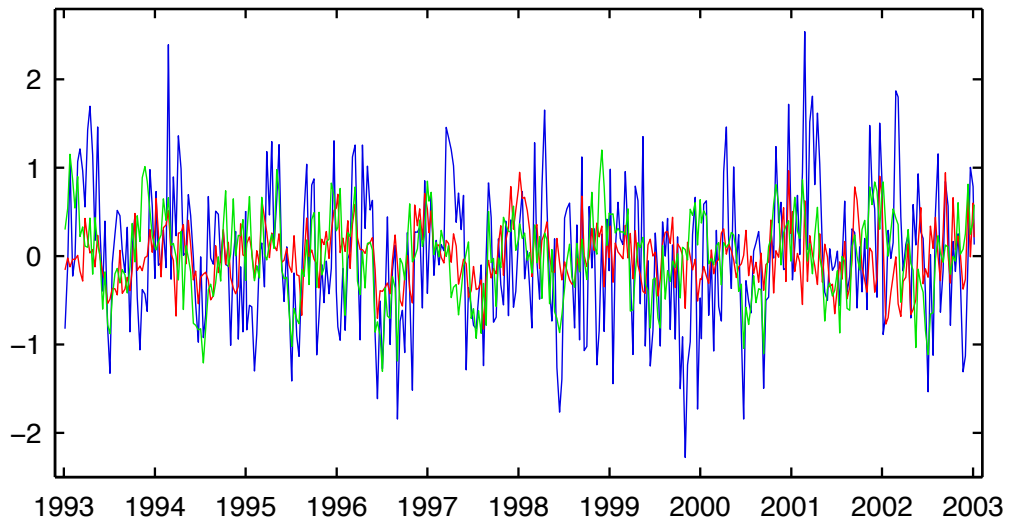

$\times 10^{-7}$ (b) ψ_2 from SP02 (blue), Winds (red), and Currents (green)

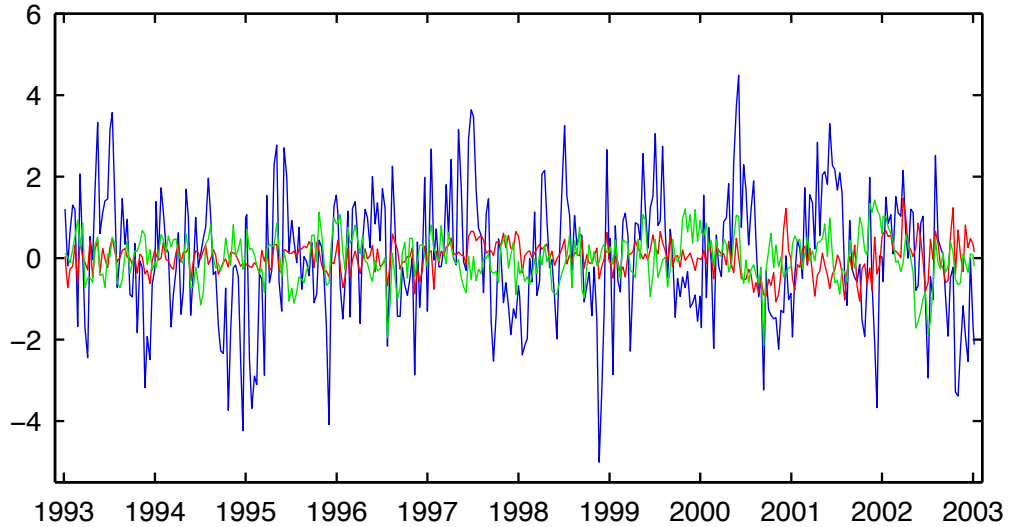

$\times 10^{-8}$ (c) ψ_3 from SP02 (blue), Winds (red), and Currents (green)

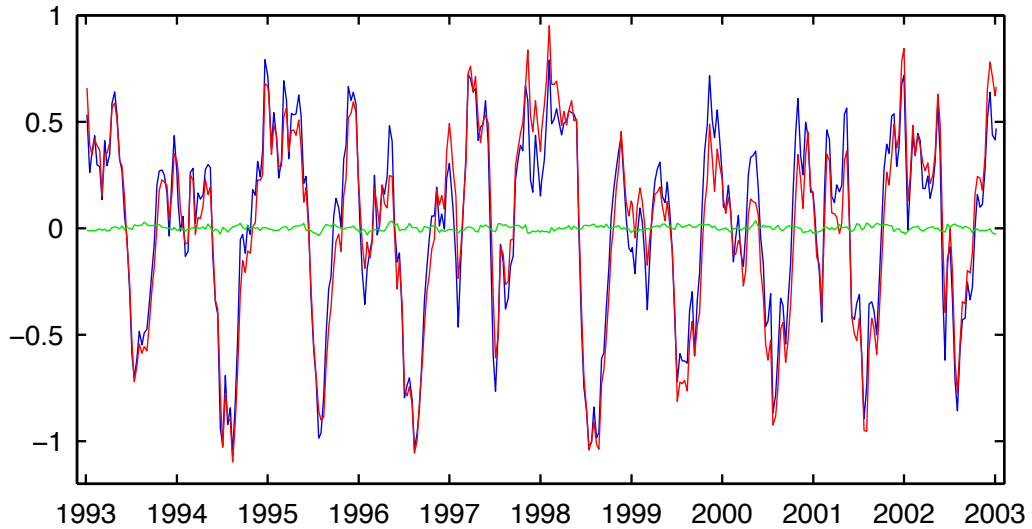

Variations in Earth Rotation & Time Variable Gravity: Insights via Space Geodesy

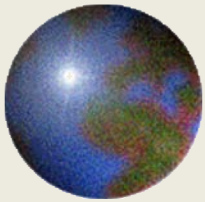

Investigators:

Jean O. Dickey, JPL PI

Dale H. Boggs, JPL Co-I

Steven L. Marcus, JPL Co-I

Collaborators

**Y. Chao (JPL), V. Dehant (Royal Observatory, Brussels - RBO),
Olivier de Viron (RBO), R.J. Eanes (CSR, UTx), M. Ghil (UCLA),
R.S. Gross (JPL), R. Hide (Imperial College, London), Andrew
Jackson (Leeds University), J.M. Wahr (Colorado), V. Zlotnicki
(JPL) +More**

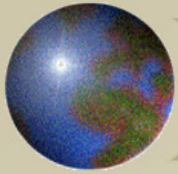

More links ...2 Science paper

Team's Expertise		
<i>Ice, Glacier & Polar Regions</i>	<i>Ocean</i>	<i>Geodesy</i>
M. Dyurgerov E. Ivins R. Kwok E. Rignot J. Zwally	Yi Chao T. M. Chin I. Fukumori M. Ghil S. Levitus	O. de Viron J. Dickey J. M. Wahr V. Zlotnicki
<i>Hydrology</i>	W. Munk	<i>Altimetry</i>
J. Famiglietti K. Trenberth	V. Zlotnicki	V. Zlotnicki
<i>Advanced Estimation Techniques</i>	<i>Atmosphere</i>	<i>Post Glacial Rebound</i>
T. M. Chin M. Ghil	D. Bromwich M. Ghil S. Marcus K. Trenberth	E. Ivins

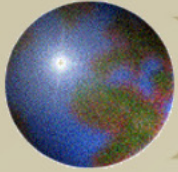

Areas of Effort

Earth Rotation Variation

- ⊕ Interactions among the Atmosphere, Hydrosphere and Solid Earth
- ⊕ Core-Mantle-Solid Earth Interactions and Core Angular Momentum

Time Variable Gravity

- ⊕ Atmospheric, Oceanic and Hydrological Mass Variations, Atmospheric, Oceanic and Hydrological Mass Variations

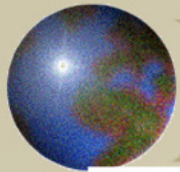

Variations in the Earth's Oblateness J_2

J_2 Observations and Sources

Ocean Bottom Pressure Difference

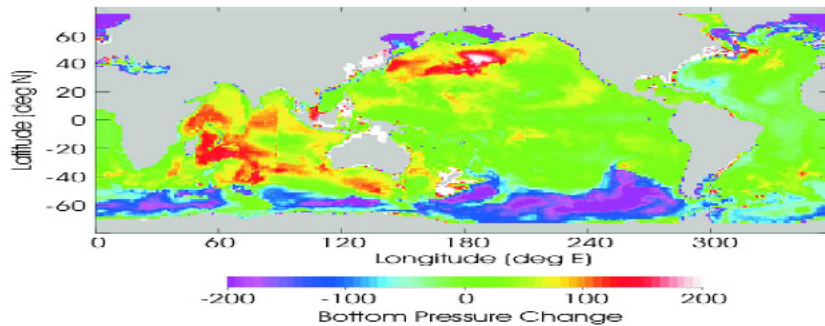

The unusual increase in the Earth's oblateness (J_2) beginning in 1997 (detected by Cox & Chao, *Sci*, 2002) is explained by (Dickey et al, *Sci*, 2002) :

- Ocean mass redistributions as analyzed by GCM (ECCO) with assimilated data
- Melting glaciers

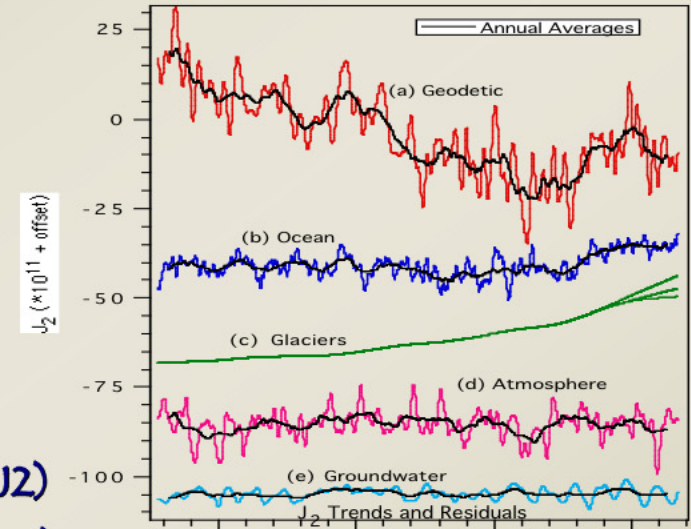

J_2 Observations & Sources

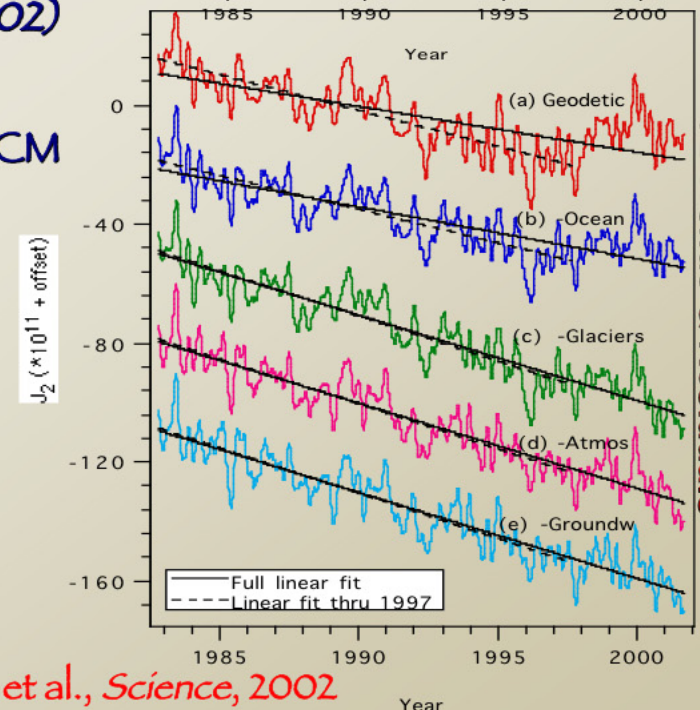

J_2 Trends & Residuals

Dickey et al., *Science*, 2002

Year

Absolute Gravimetry in the Fennoscandian Land Uplift Area: Monitoring of Temporal Gravity Changes for GRACE

Jürgen Müller, Ludger Timmen, Heiner Denker

Institut für Erdmessung

Universität Hannover

(mueller@ife.uni-hannover.de)

(presented by Chris Reigber, GFZ)



Contents

Introduction

- scientific background
- numbers

Absolute Gravimetry, GRACE

- concept
- accuracy

Absolute gravimetry campaign in Fennoscandia

- project idea
- synergy

Postglacial Land Uplift

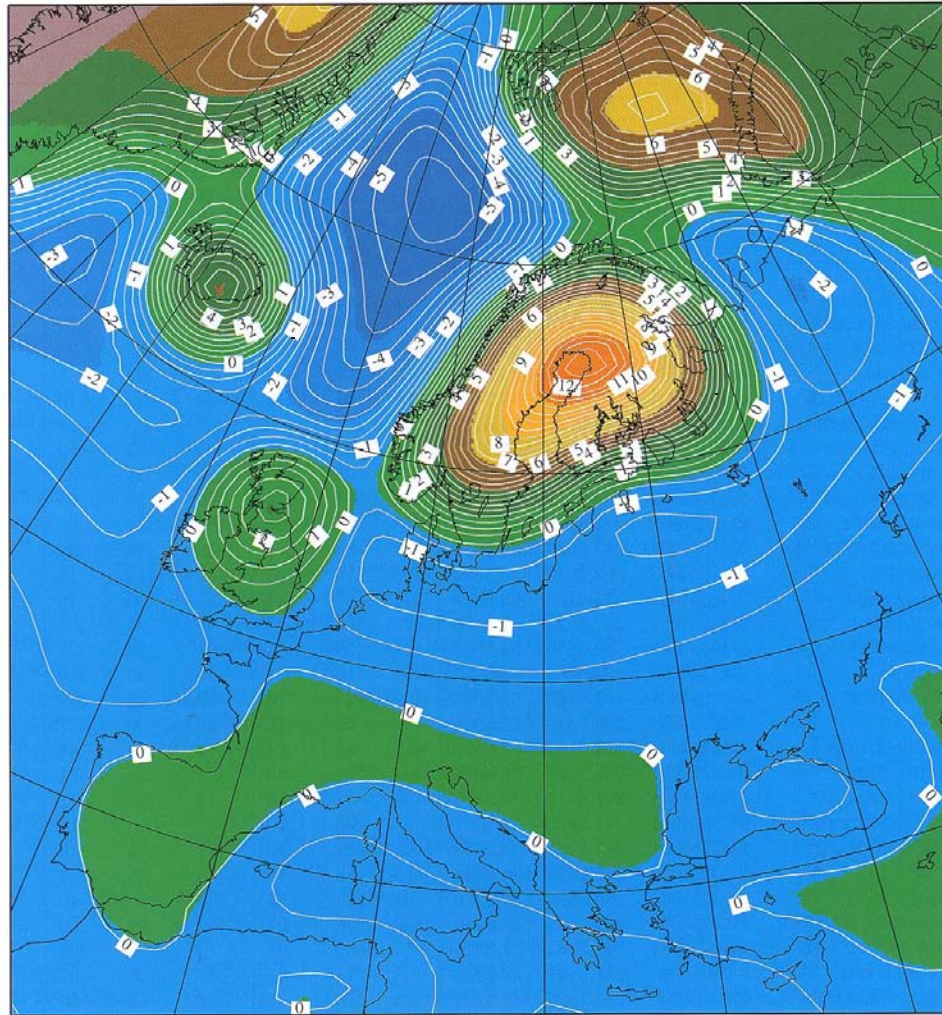

-12 mm/year

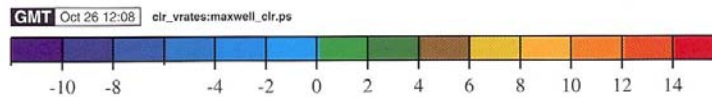

+16 mm/year

The Fennoscandian Land Uplift (Numbers)

Ekman and Mäkinen (1996):
Data: tide gauge,
 levelling 1892 to 1991

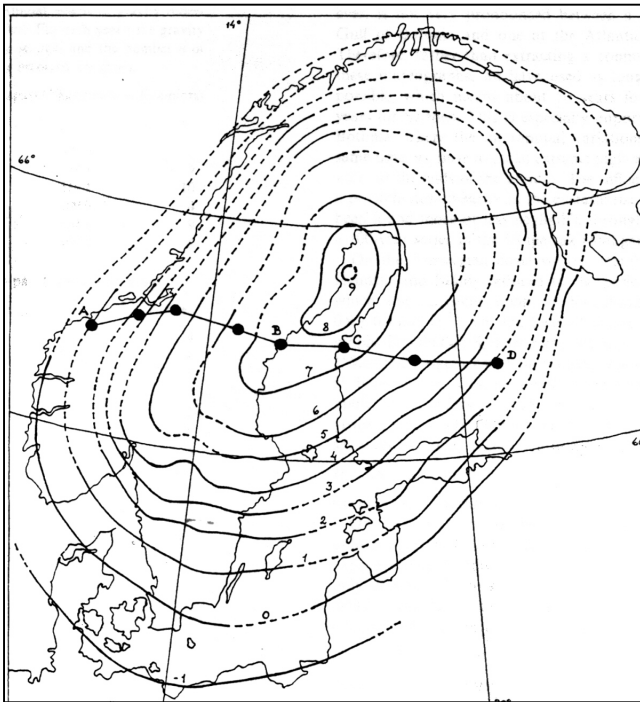

$$\dot{H}_0 = 10.2 \text{ mm/a}, \dot{N} = 0.6 \text{ mm/a}$$

$$\dot{H}_e = 1 \text{ mm/a}, \dot{g}/\dot{H} = -2 \text{ } \mu\text{Gal/cm}$$

BIFROST 2001:
 GPS 1993 to 1997,
 geophys. Model

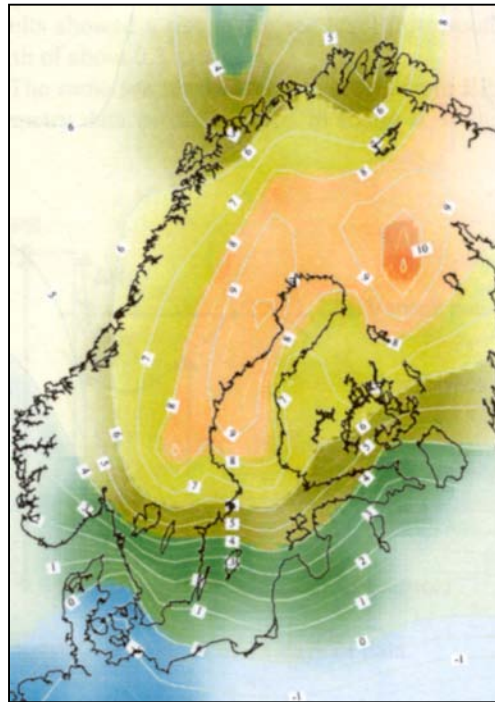

$$\dot{h}_0 \geq 11 \text{ mm/a}$$

(linear trend)

GRACE

Related numbers:

- Area extension: 2000 km (corresponds to degree 10 of spherical harmonic expansions of gravity field)
- Geoid change in 5 years: $\Delta N_0 = 3.0 \text{ mm}$
- Predicted GRACE accuracy: $\Delta(\Delta N_0) \leq \pm 0.1 \text{ mm}$ (degree 2 to 50) each month

$$\sigma(\dot{g}) \approx 0.2 \text{ } \mu\text{Gal/a} \quad (> 1 \text{ mm/a})$$

Theory

Temporal Geoid Variations Monitored by Gravimetry and GPS

$$\dot{N} = \frac{R}{4\pi\gamma} \iint_{\sigma} \left(\dot{g} + \frac{2\gamma}{R} (\dot{r} - \dot{N}) \right) S(\psi) d\sigma ,$$

$$\text{with } \dot{r} - \dot{N} = \dot{H}$$

\dot{N} temporal change of geoid height

\dot{g} temporal change of gravity

\dot{r} temporal change of ellipsoidal height

\dot{H} temporal change of orthometric height

Changes of geoid and gravity are caused by

- Mass movements in the Earth's interior
and/or
- Deformations of the Earth's crust

Terrestrial Gravimetry

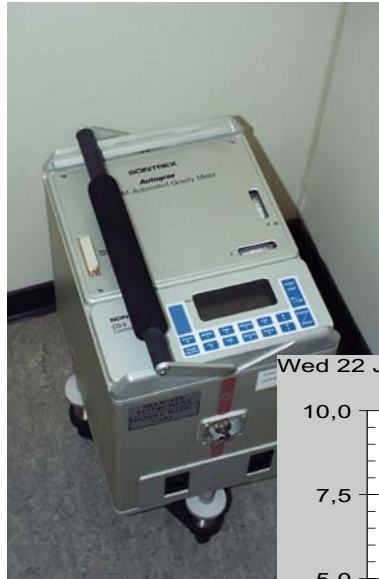
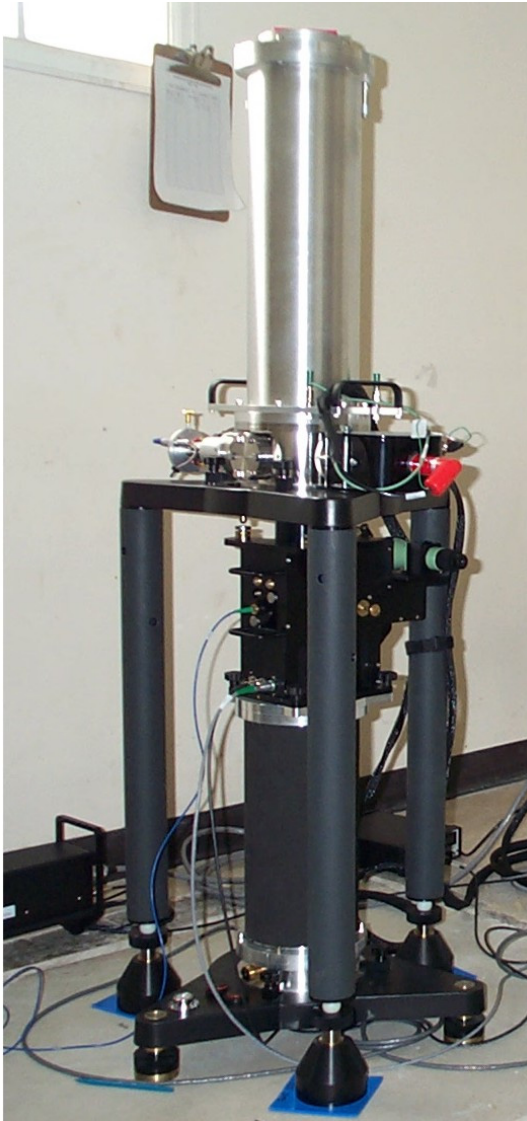

$$\sigma_g = \pm 1 \mu\text{Gal}$$

Wed 22 Jan 2003

Set Results for Clausthal 2003Jan22b

Cumulative Mean: 981115728.90 uGal +/- 1.19uGal +/- 4.33uGal

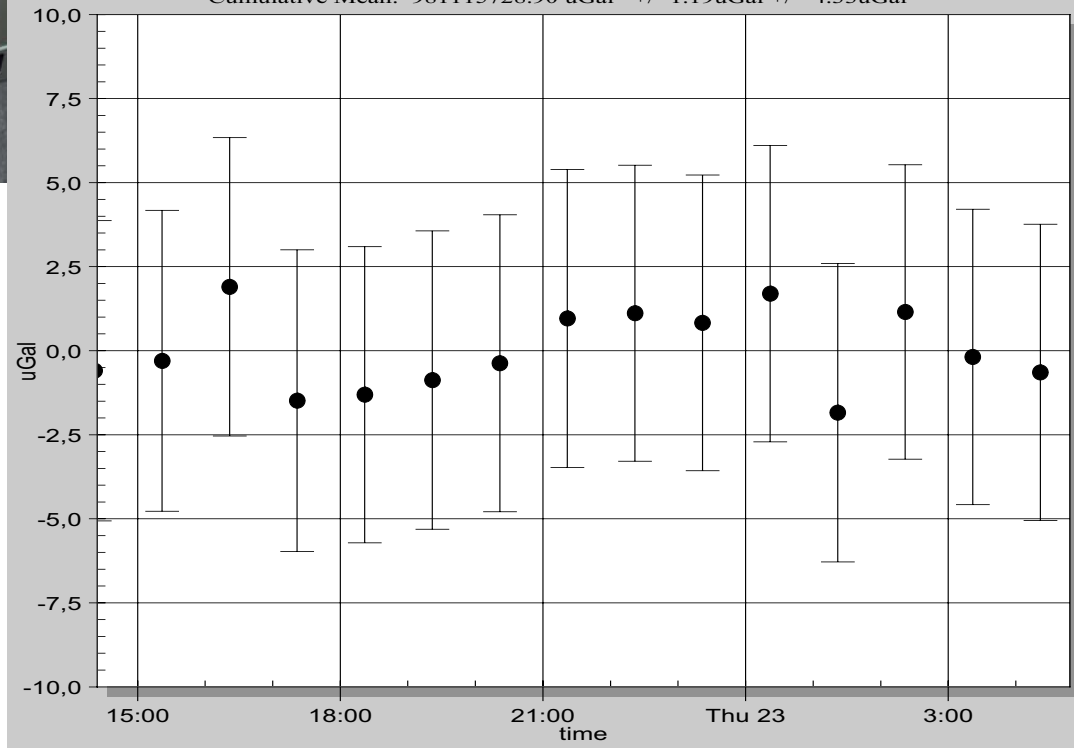

Degree Variances of Geoid Change

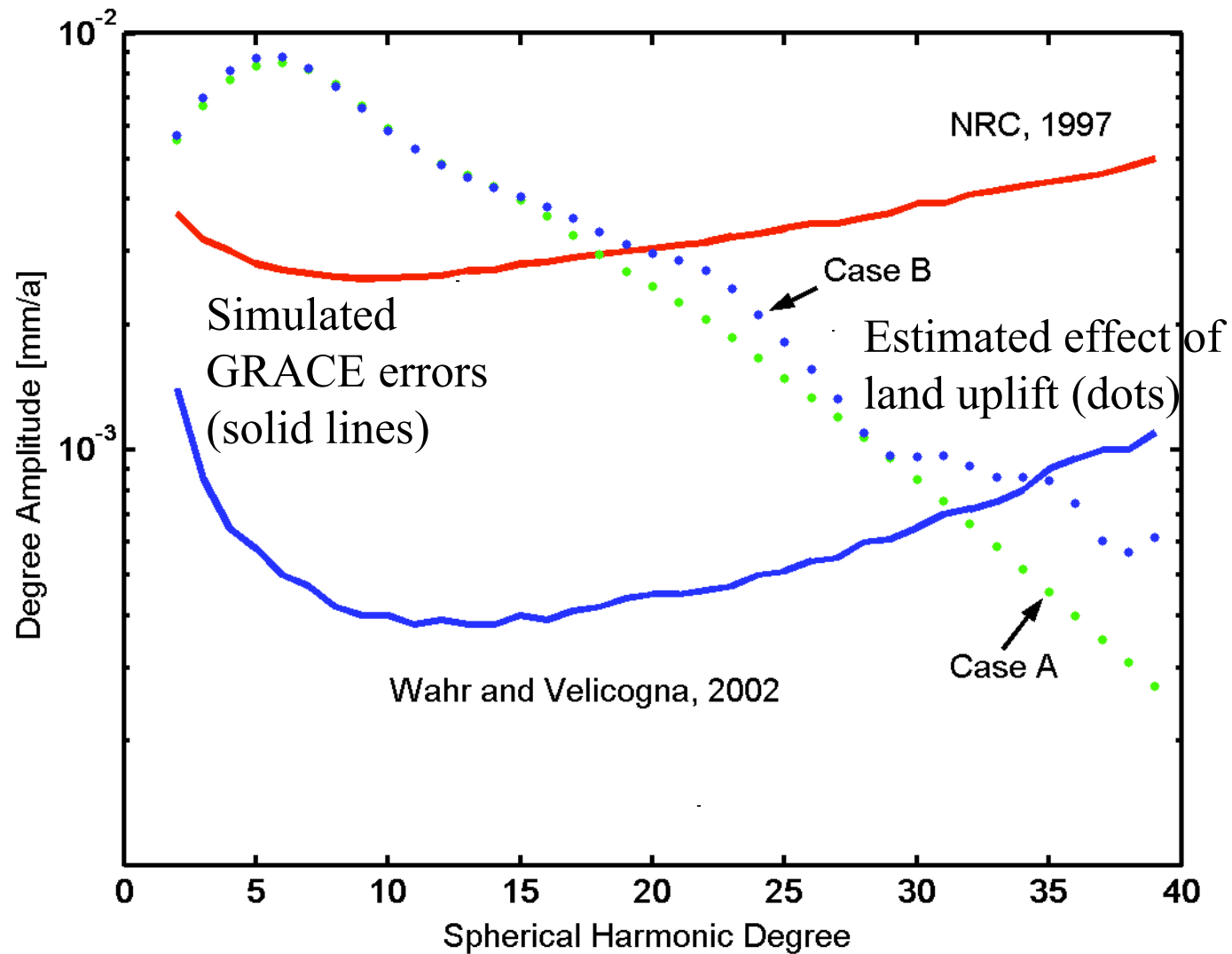

Project Idea

- IfE: Observation of max. 12 absolute gravity sites per year over 3 (5) years
- Cooperation with other institutions (NKG, FGI, BKG...)
- Connection to permanent GPS sites and tide gauges
- Reduction of time-variable parts (tidal, atmospheric, hydrological effects)
- Use of other data (GPS, relative gravity lines, tide gauges ...)
- Modelling: $\dot{g} \longrightarrow \dot{N}$
- Comparison with GRACE results, validation (point-wise)
- Improved uplift model by incorporation of GRACE data

Cooperations

Nordic Geodetic Commission (NKG)

- Denmark: National Survey and Cadastre (KMS, Copenhagen)
- Sweden: a) Onsala Space Observatory, Chalmers University of Technology (Onsala)
b) National Land Survey of Sweden (Gävle)
- Norway: a) Institute of Mapping Sciences, Agricultural University of Norway (Ås) b) Statens Kartverk (SK, Hønefoss)
- Finland: Finnish Geodetic Institute (FGI, Masala)
- Germany: Bundesamt für Kartographie und Geodäsie (BKG, Frankfurt)

Observation Plan

First absolute measurements by IFE (red) in June 2003, continuation in August/September

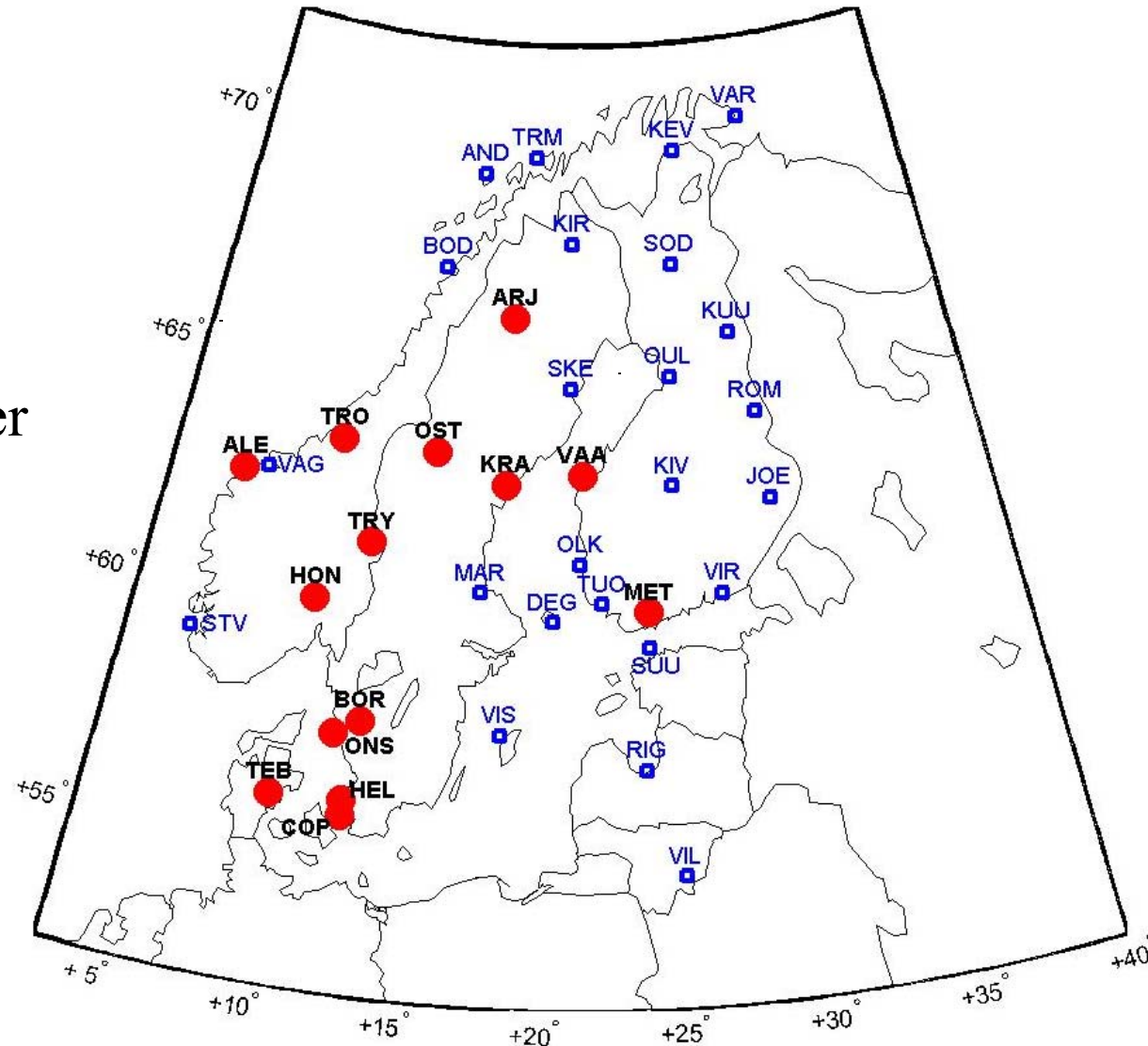

Plan in agreement with the NKG

Geoid Variations From Atmospheric Pressure Changes

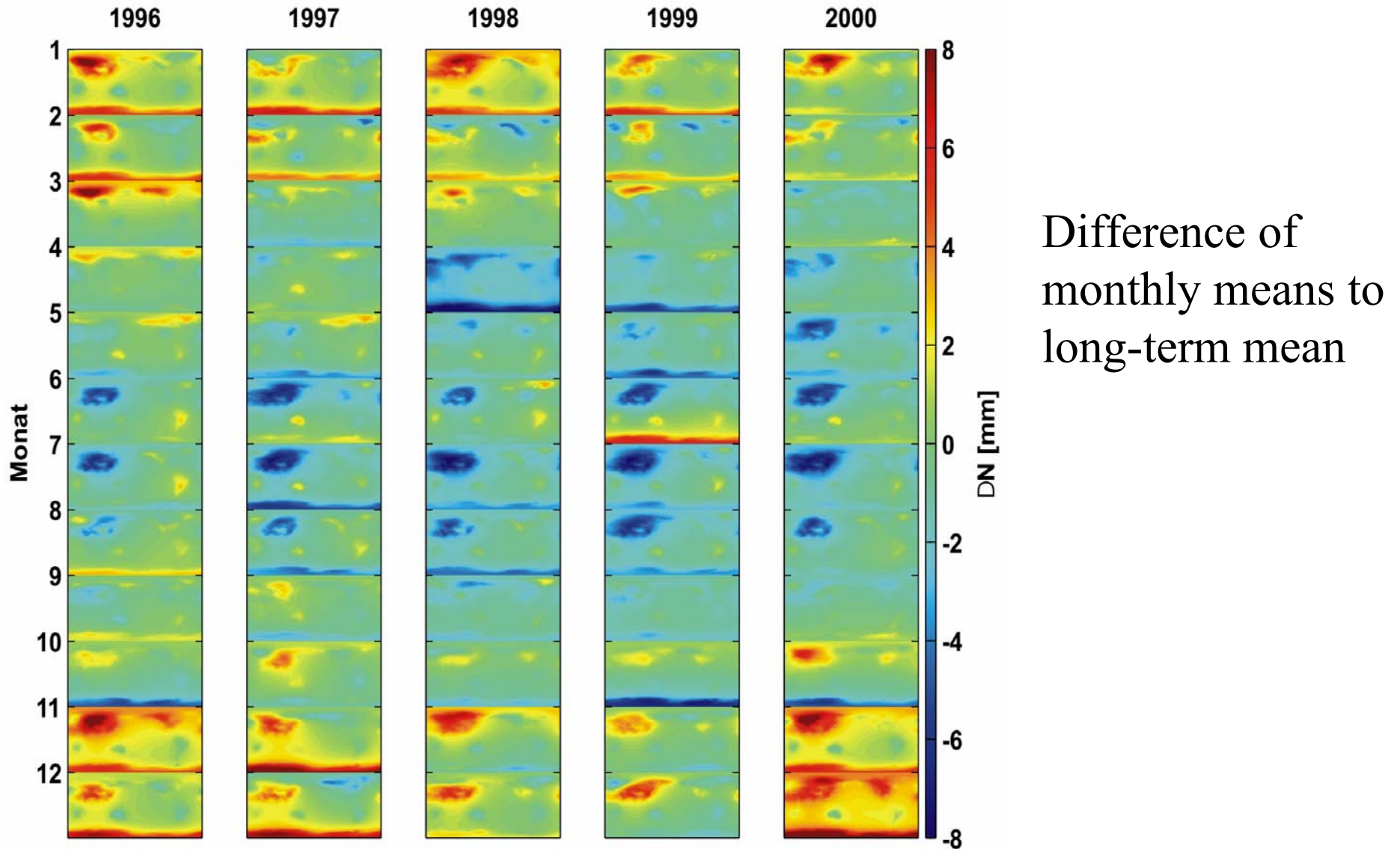

Difference of
monthly means to
long-term mean

Synergy Effect: the Fennoscandian Uplift and GRACE

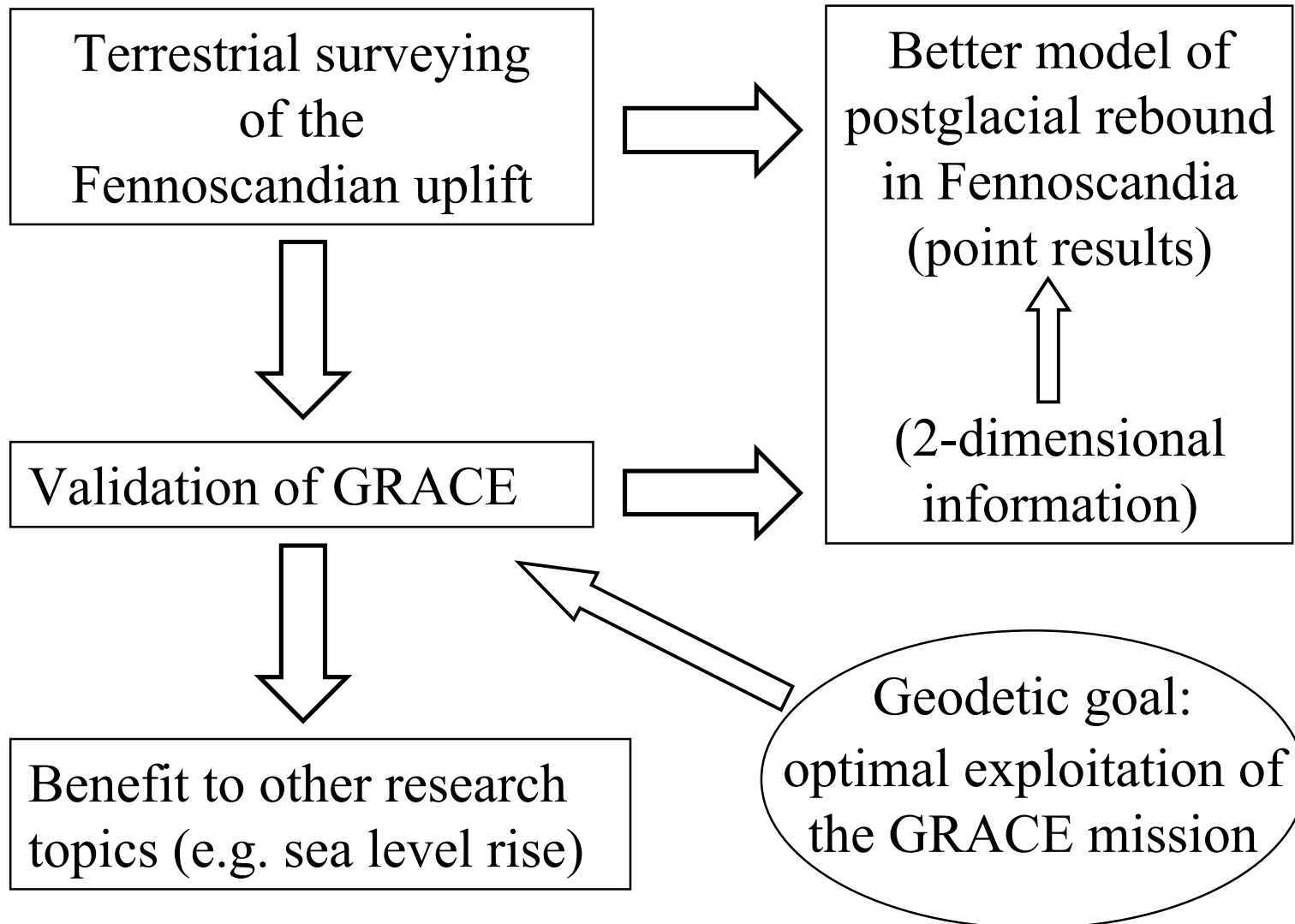

Validation of CHAMP and GRACE
temporal gravity variations with
Superconducting Gravimeter measurements
from the GGP (Global Geodynamics Project) network

- J. Hinderer, IPG Strasbourg France*
- J. Neumeyer & C. Reigber GFZ Potsdam Germany
- D. Crossley, Saint Louis University USA

* Presently at NASA GSFC USA

GGP Stations 1997 - 2003

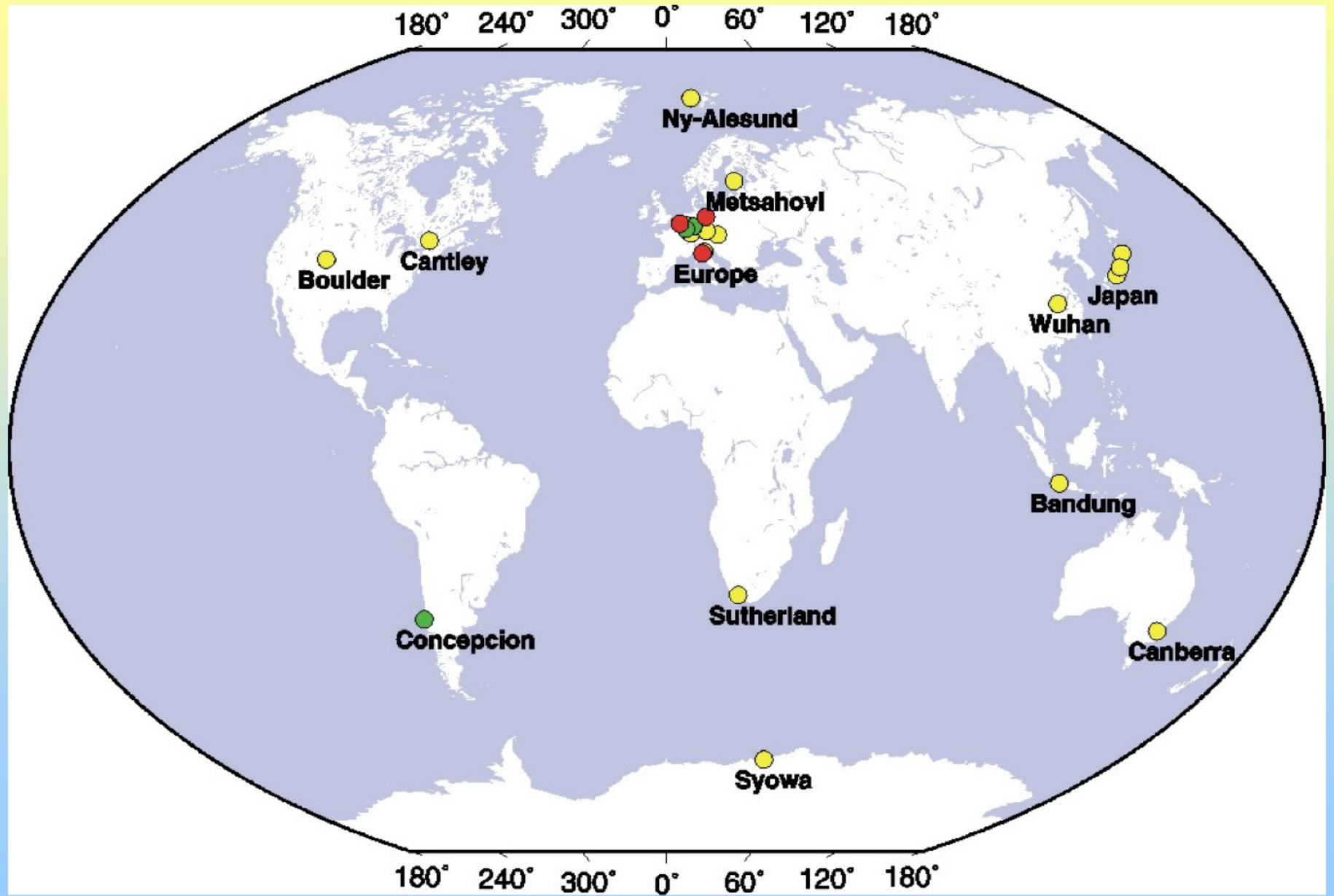



GGP Satellite Project

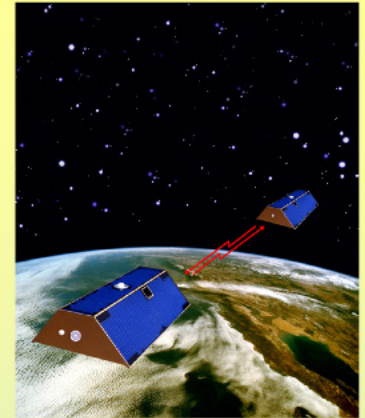

- CHAMP and GRACE satellite **calibration** and **validation**
- Provides surface gravity measurements that are **independent** of satellite observations, compared to other methods that rely on modeling
- Goal is to find and interpret large scale **coherent seasonal gravity** effects using GGP ground stations (e.g. in Europe)

Part I. CHAMP versus SG data

First comparison between Superconducting Gravimeter and CHAMP satellite temporal gravity variations

J. Neumeyer and co-authors

GeoForschungsZentrum Potsdam, Dept. Geodesy and Remote Sensing, Germany



Selected Superconducting Gravimeter stations for comparison with CHAMP Satellite gravity variation measurements

- 6 SG stations
- 1 year of data (12/00-12/01)

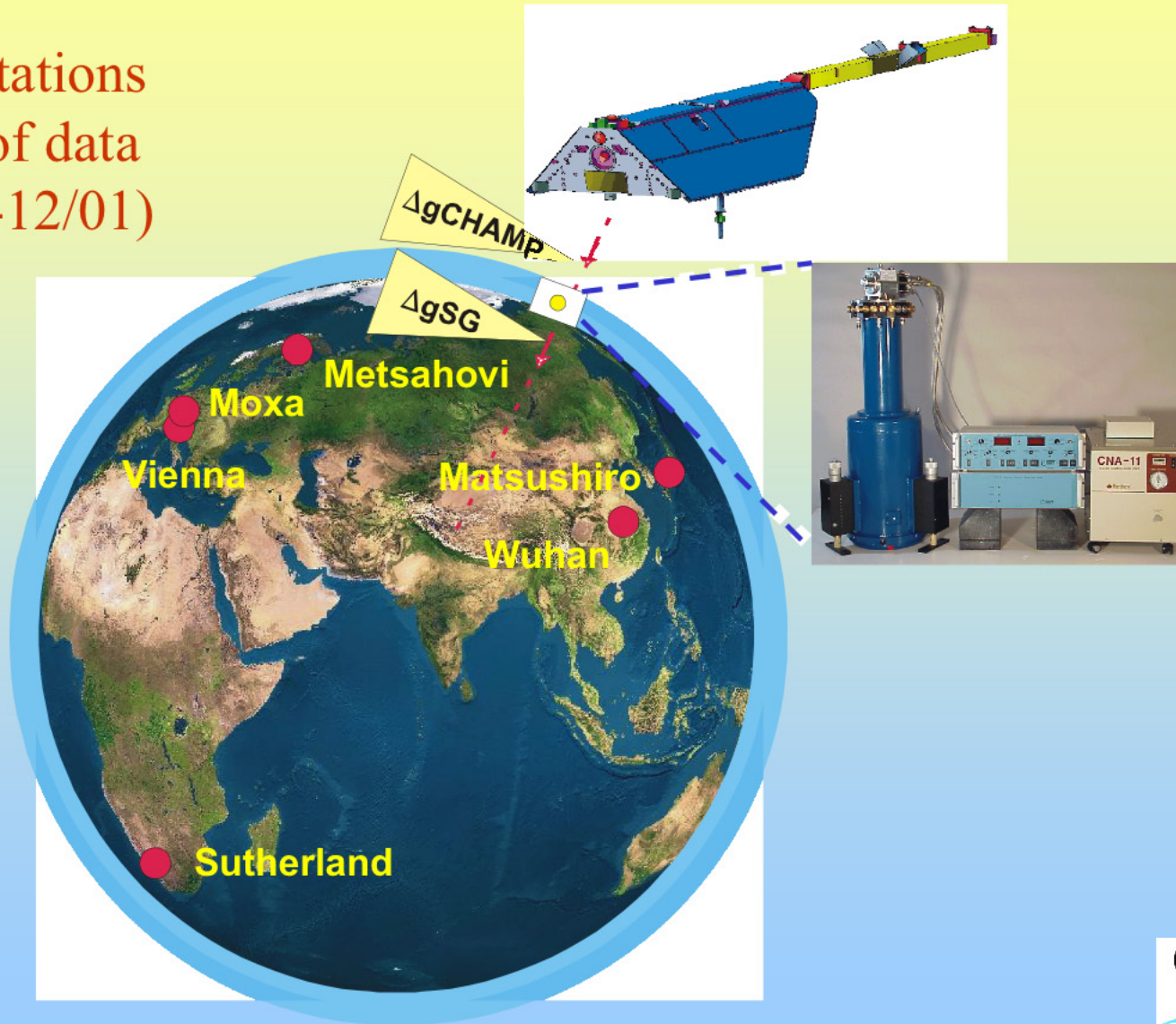

Performance comparison

	CHAMP	GRACE	Superconducting gravimeter
Gravity resolution	300 μ gal 1 μ gal	0.1 μ gal 2 μ gal	1 nanogal
Spatial resolution /2	500 5000 km	500 250	Point measurement
Spherical harmonic expansion	40 4	40 80	
Temporal resolution	1 month	1 month	10 sec
Long term stability	No drift	No drift	3 μ gal/year

Processing SG data

Raw gravity data

Preprocessing

Spikes and offsets $> 0.5 \mu\text{gal}$ corrected
low pass filtered

Instrumental drift removed

Gravity reduction

Air pressure induced gravity effect

Earth tides (analysed tidal parameters WD- model)

Ocean loading (FES 95 model)

Polar motion (IERS data, gravimetric factor 1.16)

Local groundwater level induced gravity effect

Gravity variations (GrV)

Monthly mean of the gravity variations (mGrV)

CHAMP Recovery of Temporal Gravity Field Variations

Input data

CHAMP-GPS satellite to satellite tracking and accelerometer data
Satellite Laser Ranging data of Lageos 1 and 2, Starlette and Stella

Gravity field solution

EIGEN-2CHAMP+4SLR: Spherical harmonic coefficients of the gravitational potential complete to degree/order 120,
Coefficients up to degree/order 4 solved at monthly intervals

Gravity reduction

Air pressure effect (attraction and loading term) using ECMWF data

IERS Earth tide model applied (semidiurnal to long period constituents)

FES 2000 ocean tide model applied (semidiurnal to long period constituents)
including ocean loading

Polar motion using IERS polar motion data

Monthly gravity variations for SG coordinates from 12 sets of
spherical harmonic coefficients up to degree/order 4 ($\lambda/2 = 5000$ km)

Gravity variations at Superconducting Gravimeter sites

Distance Vienna - Moxa 435 km

Distance Wuhan - Matsushiro 2300 km

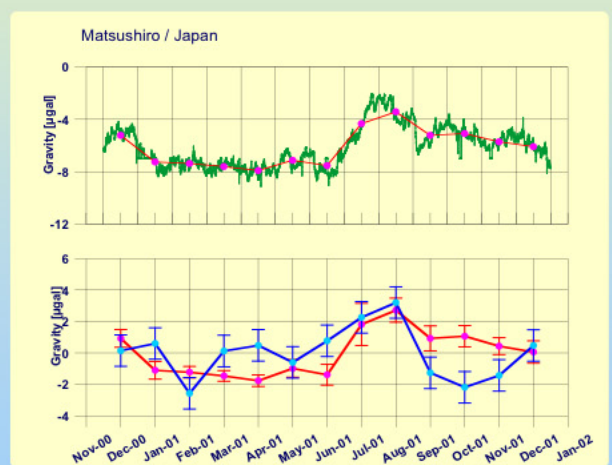
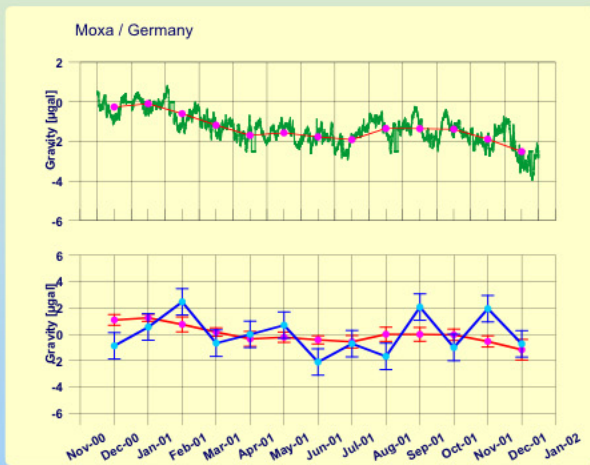
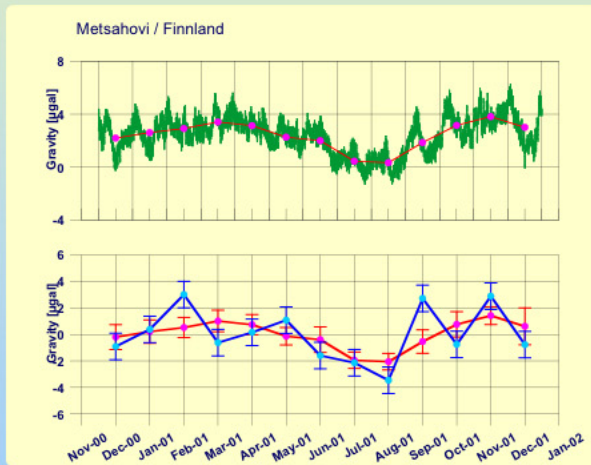
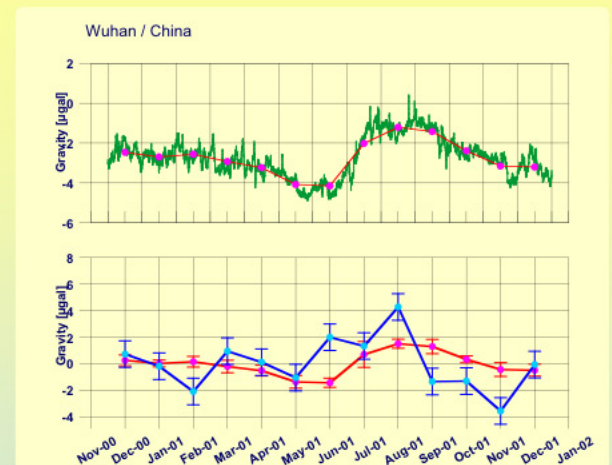
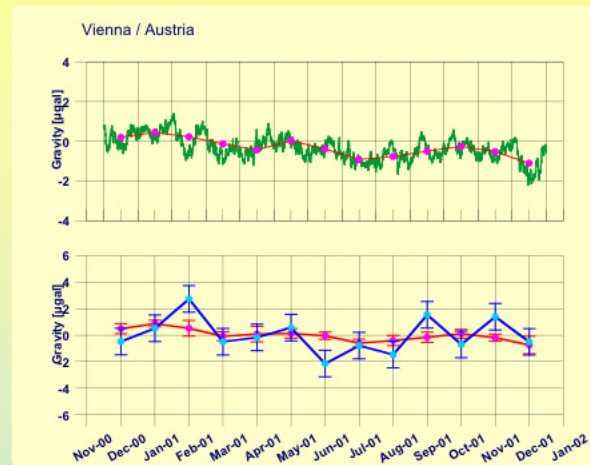
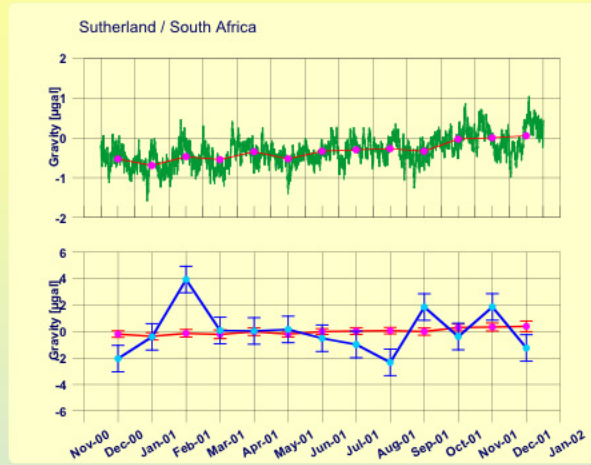

Upper graph: **green** = SG: Gravity variations (GrV)

red = SG: Monthly mean of gravity variations (mGrV)

Lower graph: **blue** = CHAMP: monthly global gravity field solution for the SG sites (mS)

red = SG: Monthly mean of gravity variations (mGrV)



Part II. Validation of GRACE data using SG?

Time variations of the European gravity field
from superconducting gravimeters

D. Crossley, Saint Louis University, USA

J. Hinderer, NASA GSFC/ IPG Strasbourg

J.-P. Boy, NASA GSFC/ IPG Strasbourg

- 8 SG stations
- 4.5 years 07/97 – 12/01

GGP Stations – Europe 1997 - 2003

BE Belgium
BR Brasimone
PO Potsdam

MB Membach
MC Medicina
ME Metsahovi
MO Moxa
ST Strasbourg
VI Vienna
WE Wetzell

BH Bad Homburg
WA Walferdange

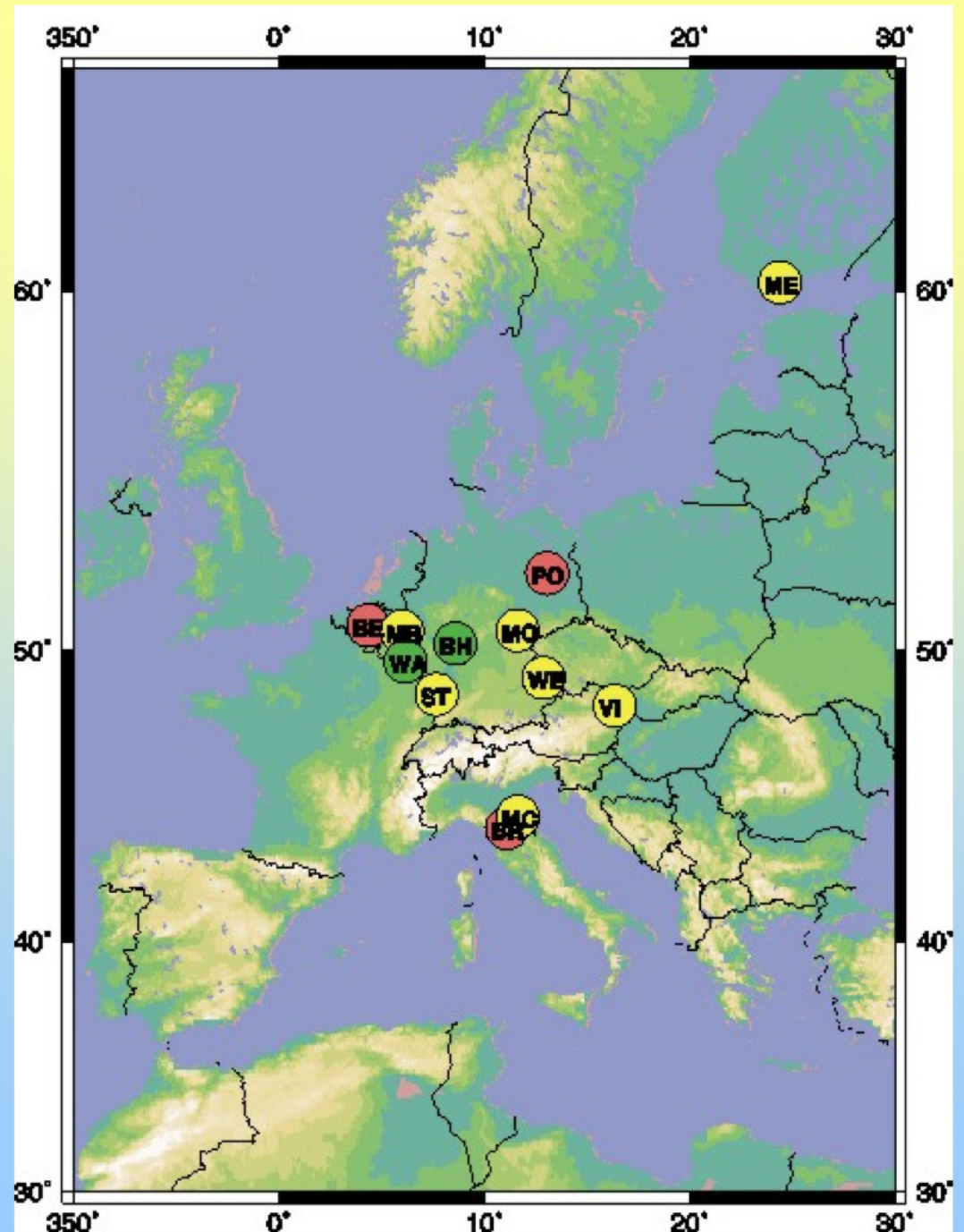

Station Residuals

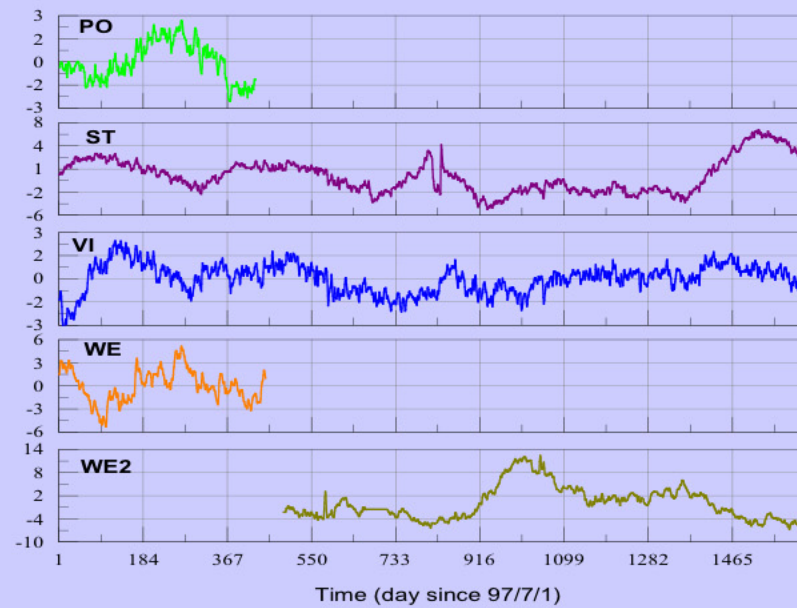
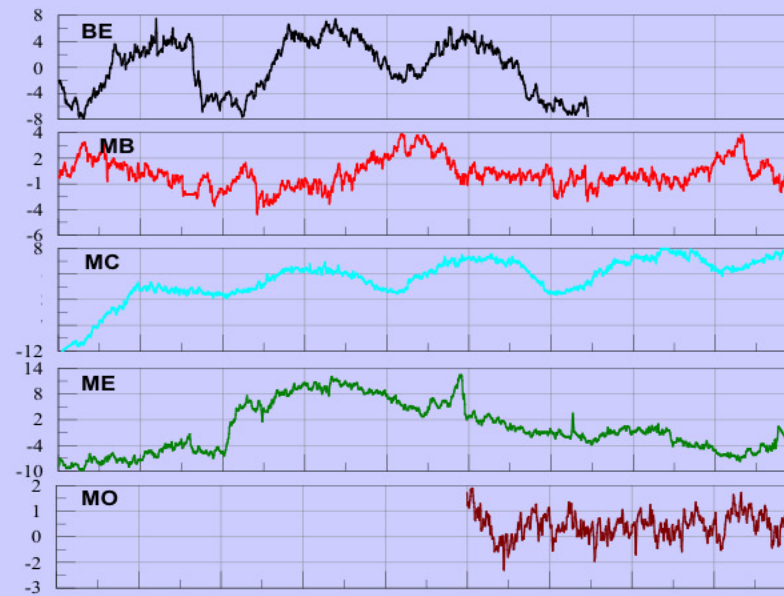

Spatial Smoothing

- Insufficient data to reconstruct a smoothed field from spherical harmonic analysis
- Insufficient station data to fit a surface directly

Two methods:

- fit a polynomial 2-D surface to the minimum curvature surface
- EOF decomposition

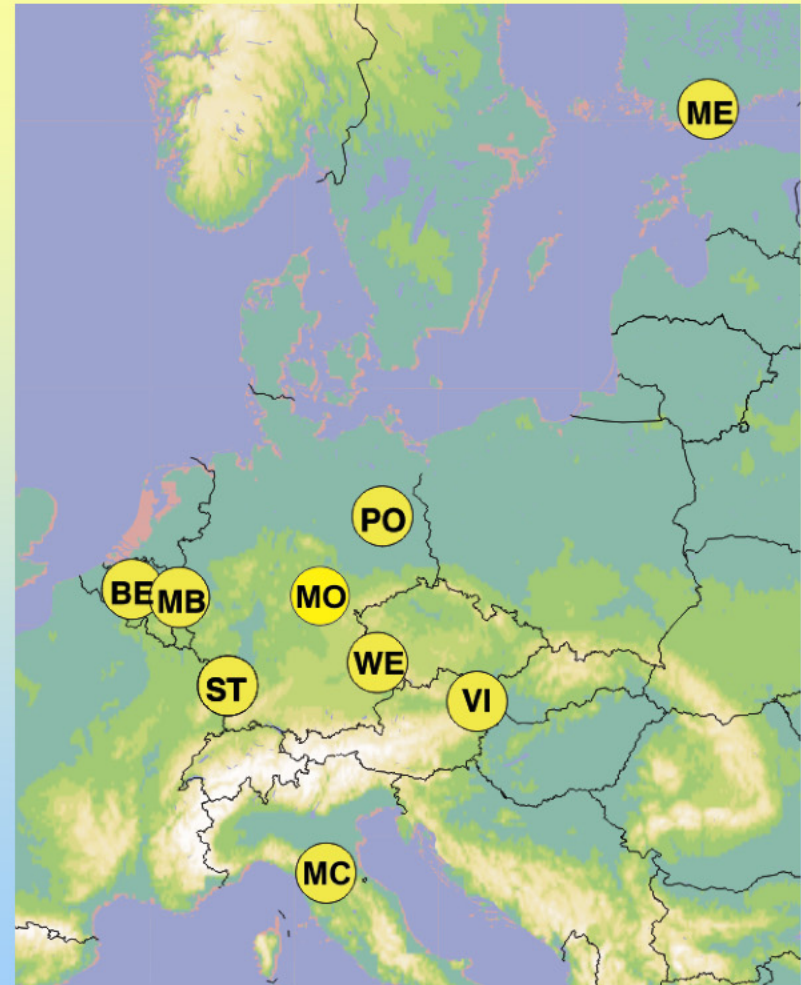

Average Gravity from Polynomial Surface

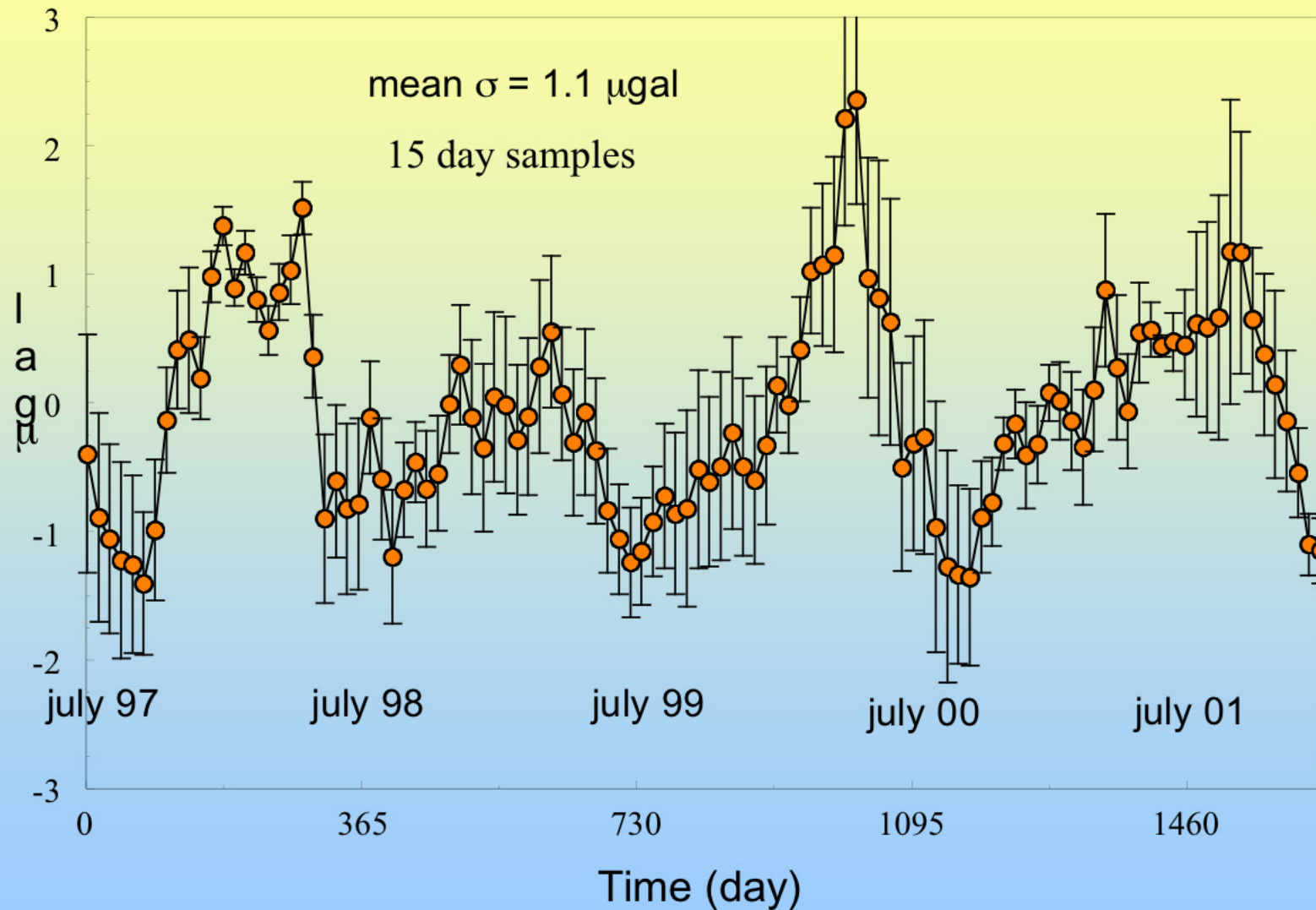

_ detection of a coherent annual signal over Europe
which should be seen by GRACE

EOF decomposition of surface gravity changes

Mode 1 (first eigenvector) - Variance Reduction 47.5%

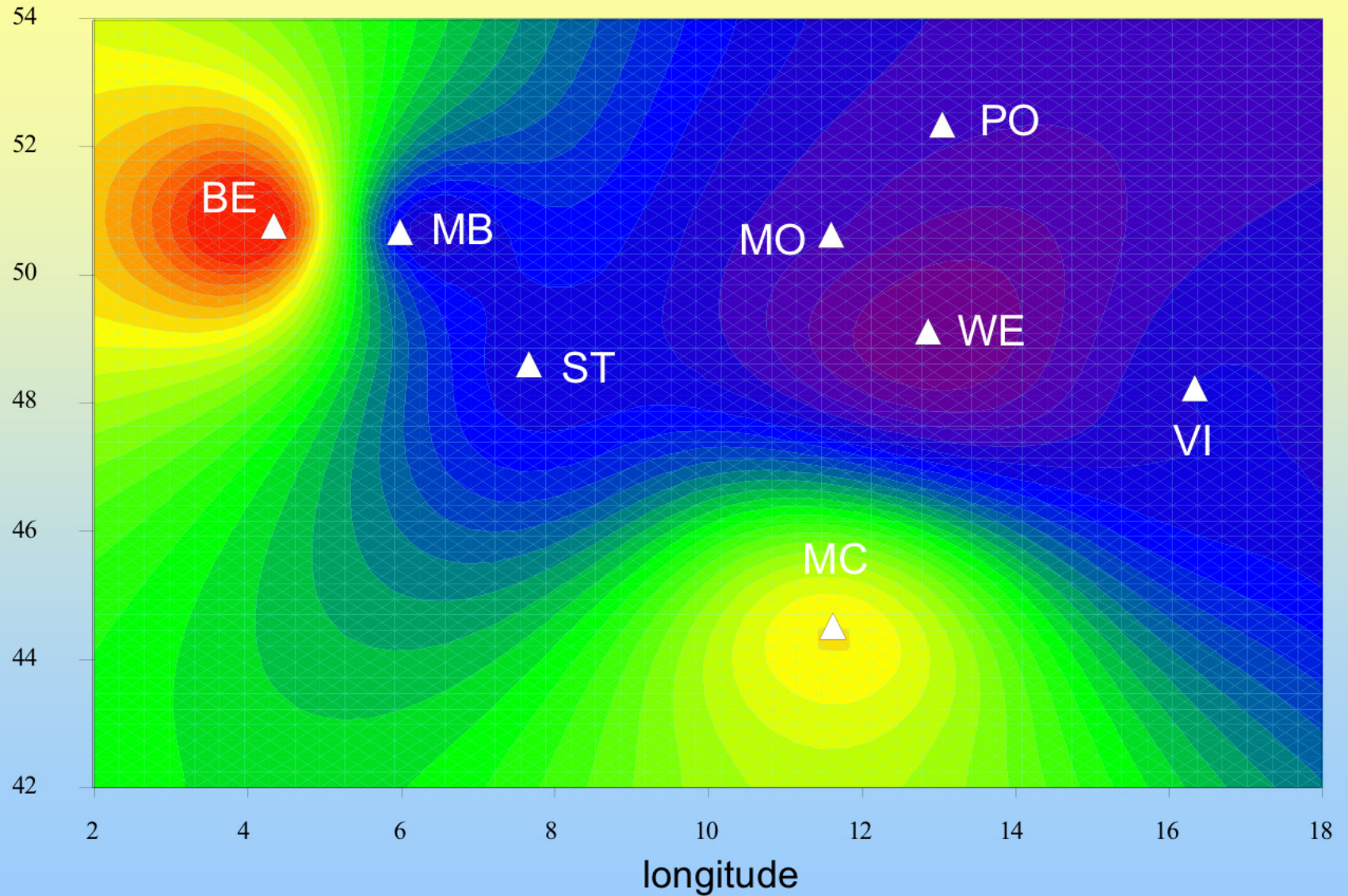

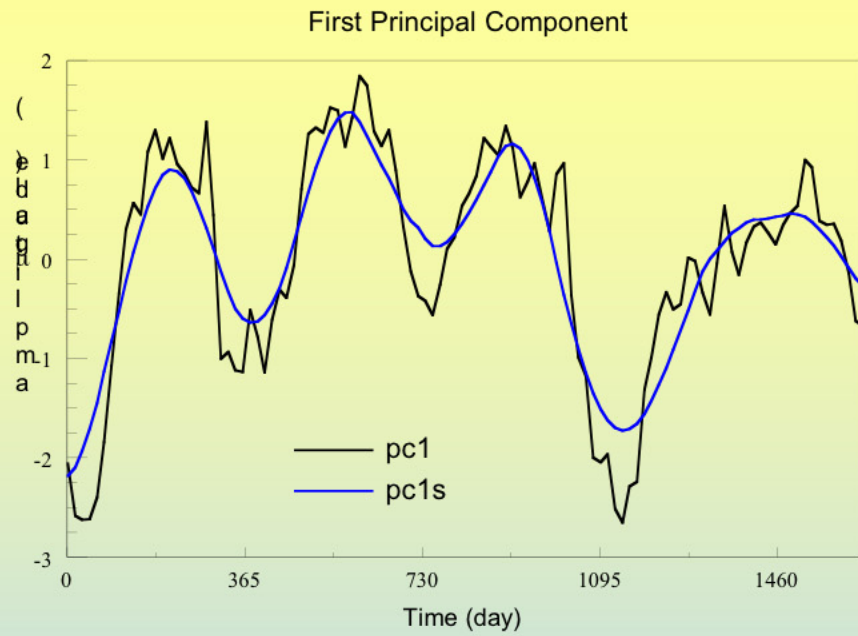

strong annual signal

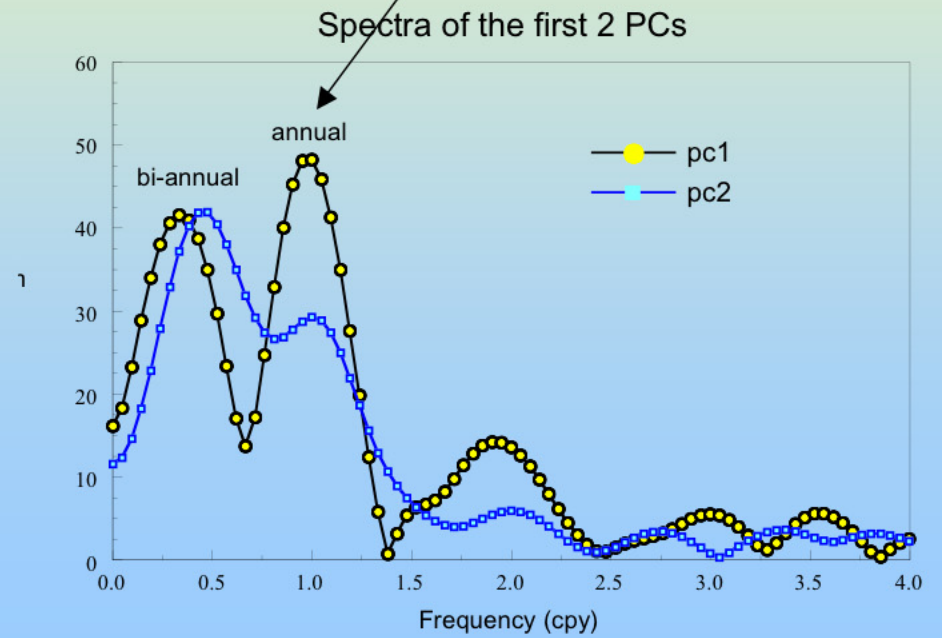

Comparison - pc1 with polynomial surface

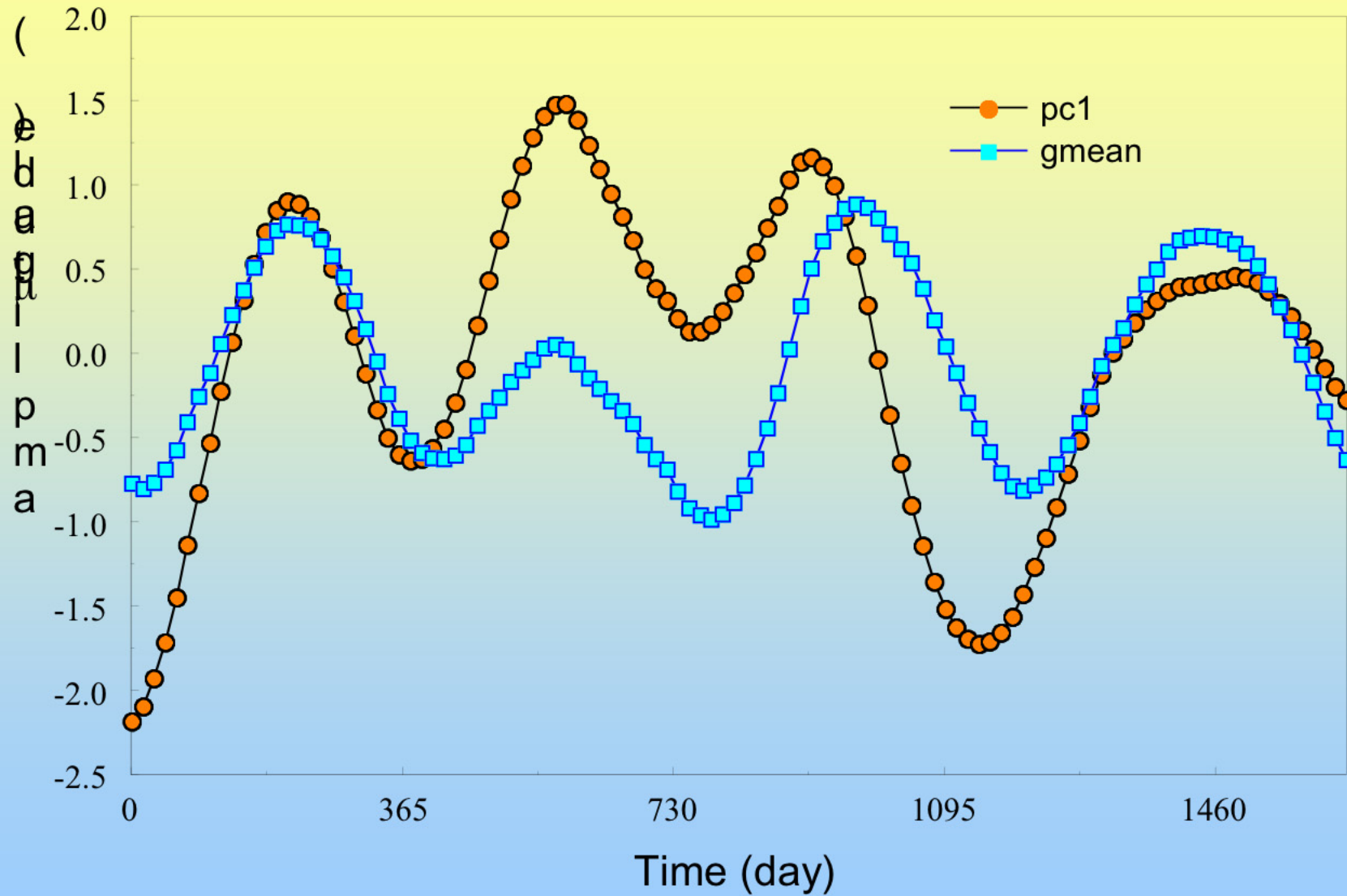

Interpretation of Annual Signals

- Local:
 - Instrument effects, thermal anomalies, vegetation, groundwater, surface water, soil moisture
- Regional and global:
 - Atmospheric pressure (3-D) attraction / loading
 - Ocean circulation, loading
 - Hydrology
 - Soil compaction

An example of continental hydrological contribution to surface gravity and displacement in Strasbourg (France)

Vertical motion (GPS)

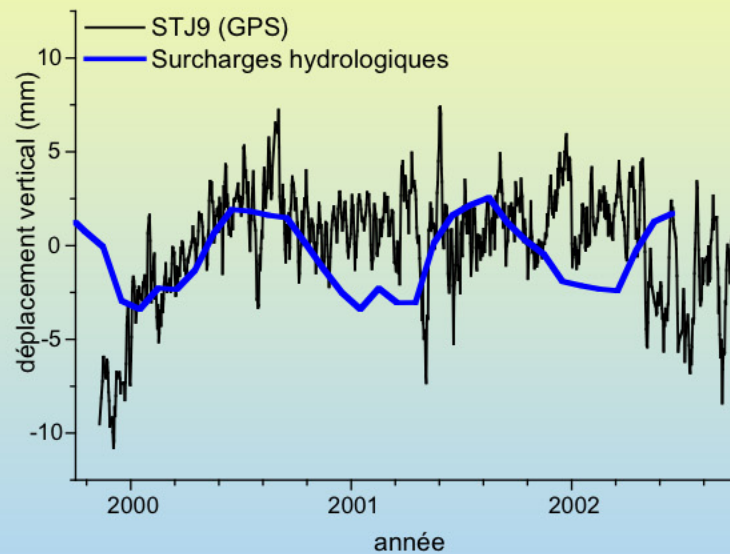

Gravity (SG)

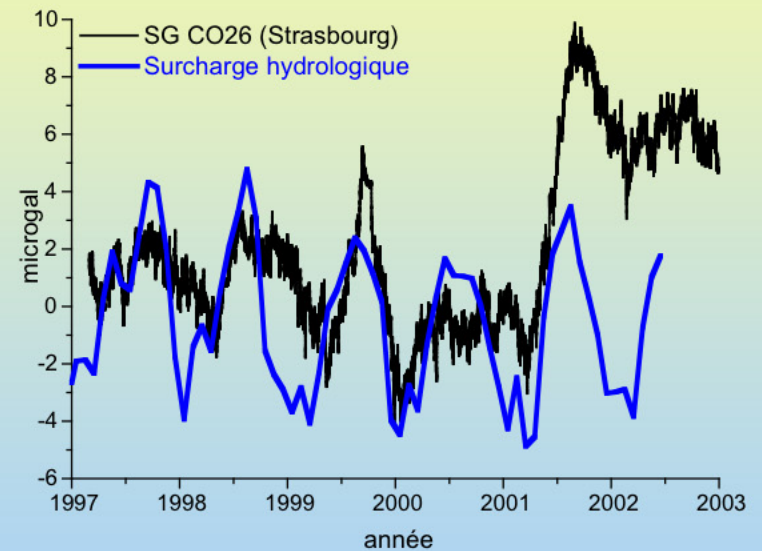

Land Dynamics (LAD) model by Milly & Shmakin (2002)
Monthly values on a 1° global grid

Predicted Total Hydrology

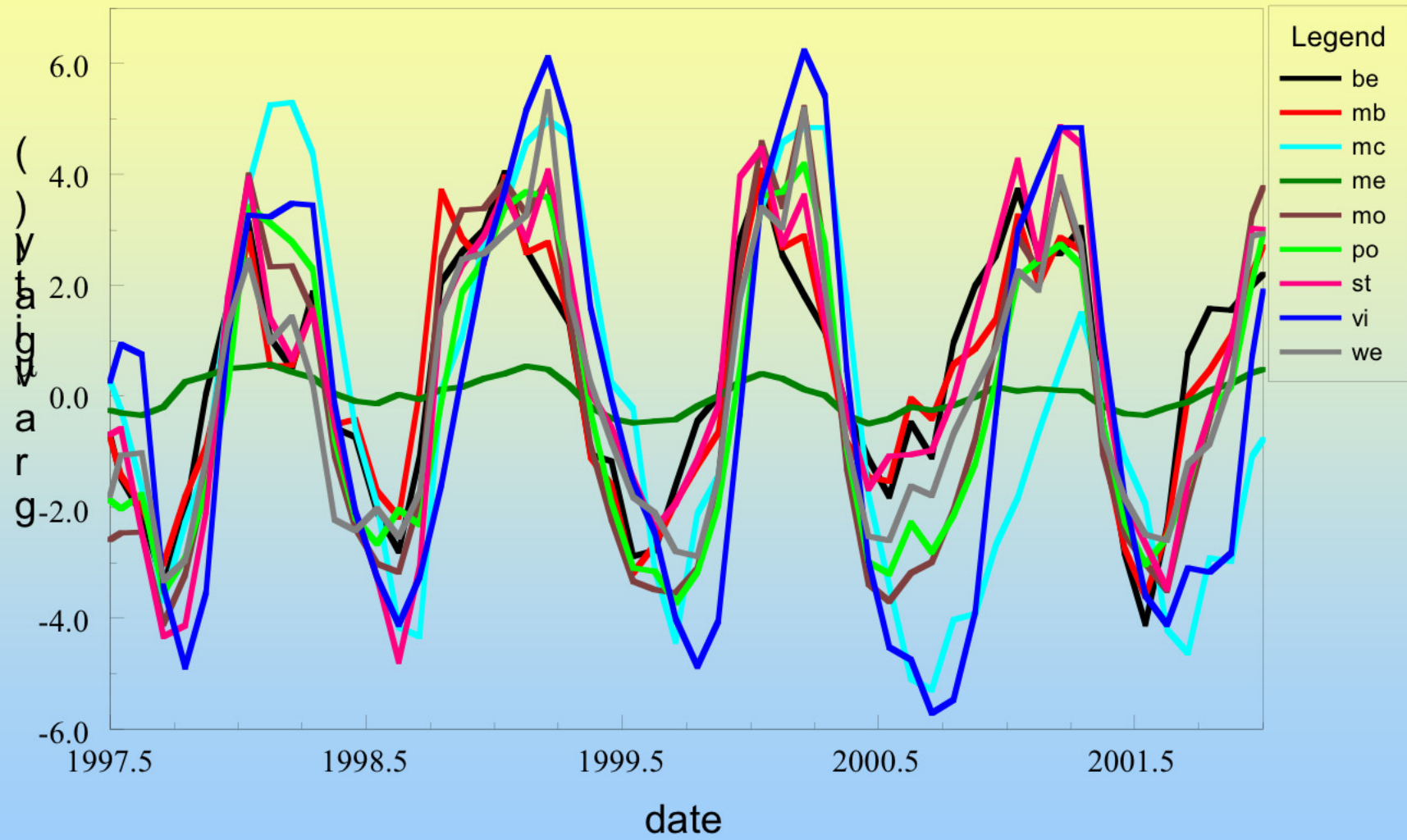

Soil moisture + snow

global 1° grid

monthly values

Comparison - pc1 with predicted total hydrology

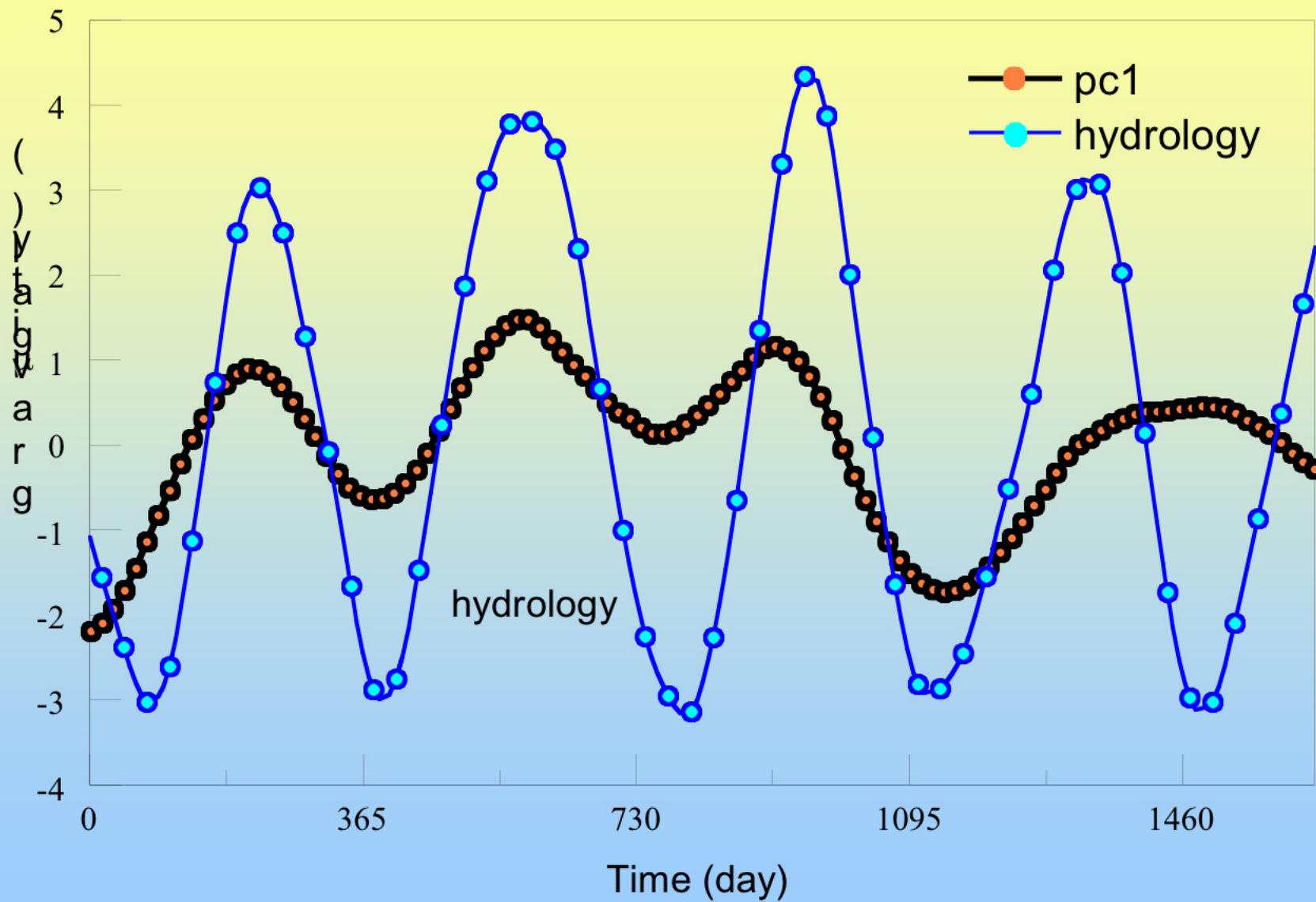

EOF decomposition of gravity changes induced in Europe by Milly & Shmakin (2002) hydrology model

First eigenvector
75 % variance reduction

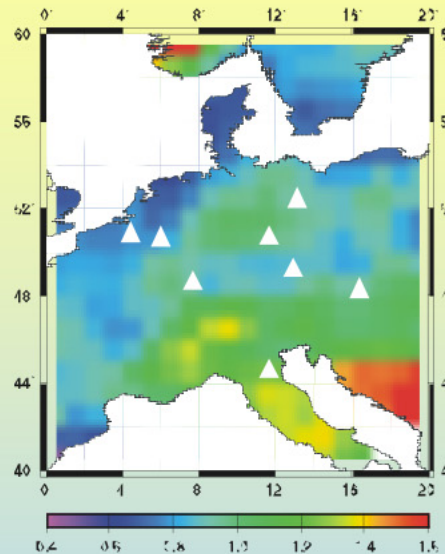

Spatial coherence
in Europe

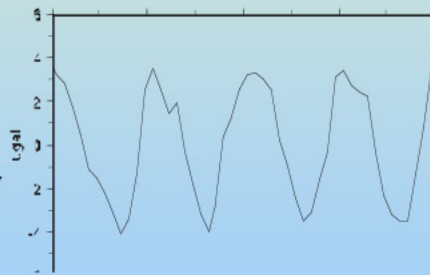

Clear annual signal

Conclusions and Future Work (1)

- GGP database will monitor gravity variations for satellite missions; **European sub-network** optimally suited to extract large scale **coherent** gravity changes
- Both SGs and AGs are required to confirm drift and offsets at the 1 microGal level
- GPS measurements required to correct for **ground vertical deflection**; requires > 4 years to define secular trends
- **Atmospheric** loading should be done with full 3-D modeling, as for GRACE
- More **hydrological** studies, including soil moisture and continental water loading, are required
- The **long periodic tidal waves** are well determined by ground measurements and therefore they can be used as reference for validation since there is a known ratio R between satellite and ground gravity changes (Love number combination which leads to $R = 0.47$ for $n = 2$ LP tides)

Conclusions and Future Work (2)

- **Existing SG stations of the GGP network**
 - single station solution: only possible if local effects are well modeled (need for auxiliary data like water table levels)
 - network solution to enhance common signals versus local ones (EOF)

- **Possible SG/AG campaigns in the future**
 - null test in areas where air pressure, ocean and hydrological contributions are small and/or well modeled
 - search for strong signals like hydrological ones in specific regions (i.e. the Amazon Basin)

Geodetic & geodynamic studies of postglacial rebound in Patagonia

Michael Bevis

Ohio State University

GPS velocities

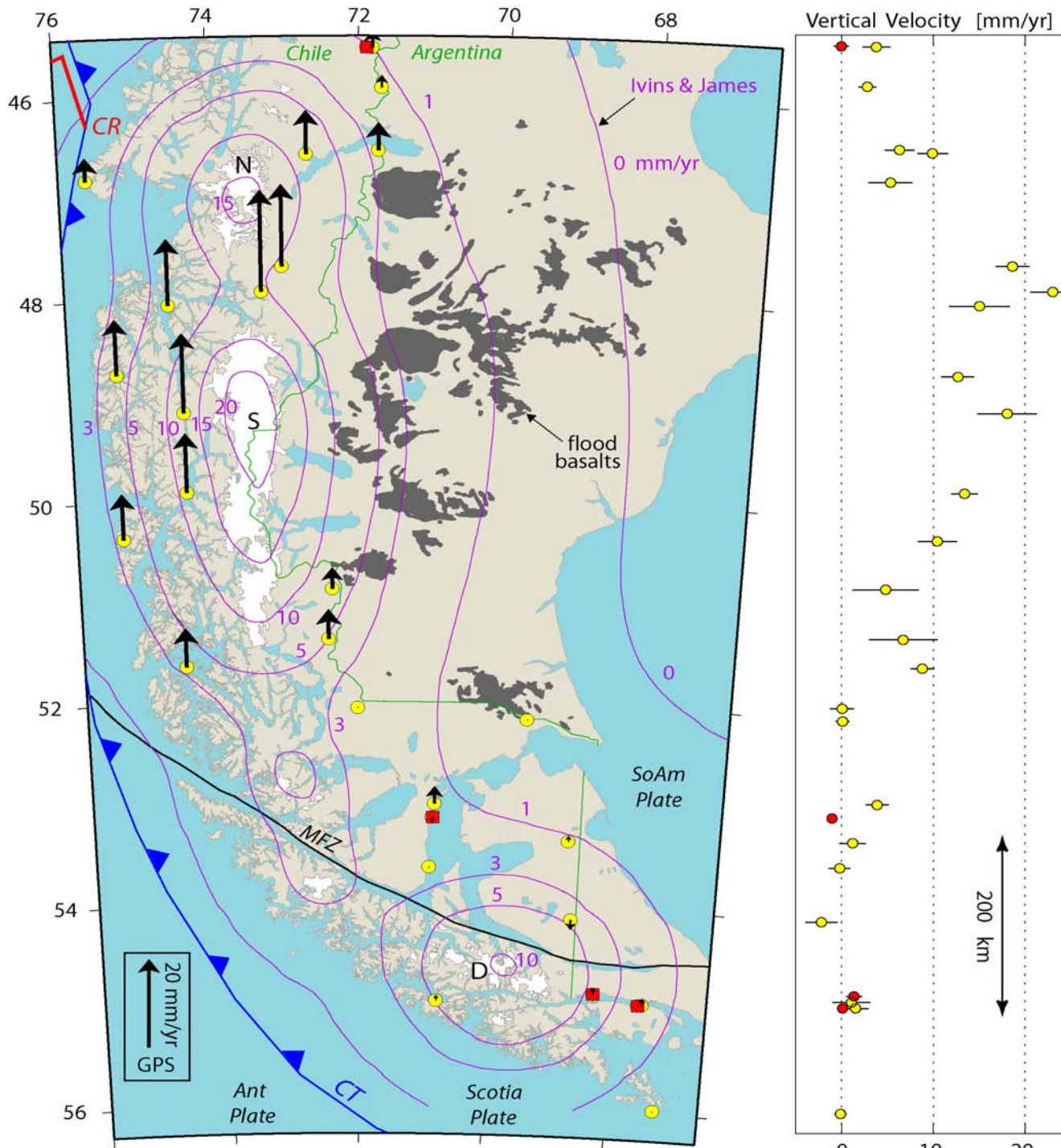

PGR

An interplay between

- Ice load history
- Geomechanical structure
 - Mantle viscosity profile
 - Lithosphere thickness

And geomechanical structure reflects tectonic setting!

Patagonia is special because the juxtaposition of

ICE (the Patagonian Icefields) &

FIRE (anomalous thermal structure due to subducted MOR)

has rendered the area with an exquisite sensitivity to Late Holocene climate change - especially the Little Ice Age

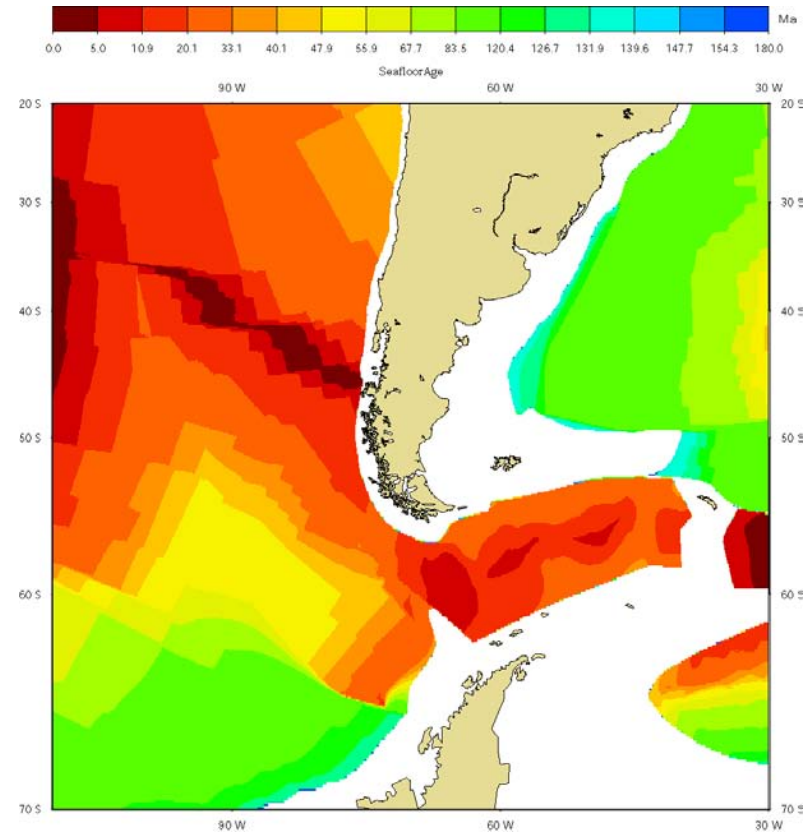

Environmental Loading in Japan (Heki)

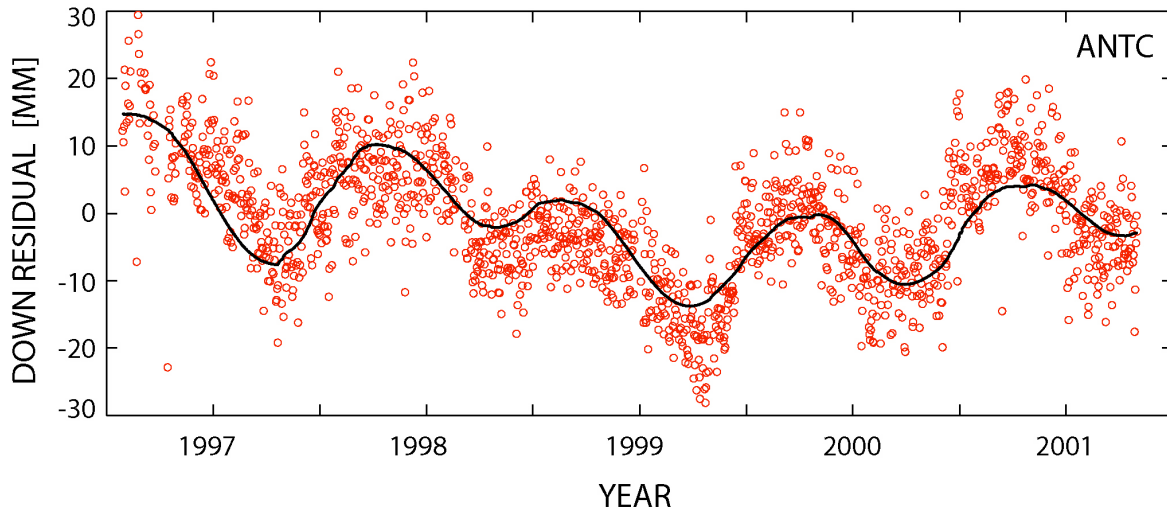
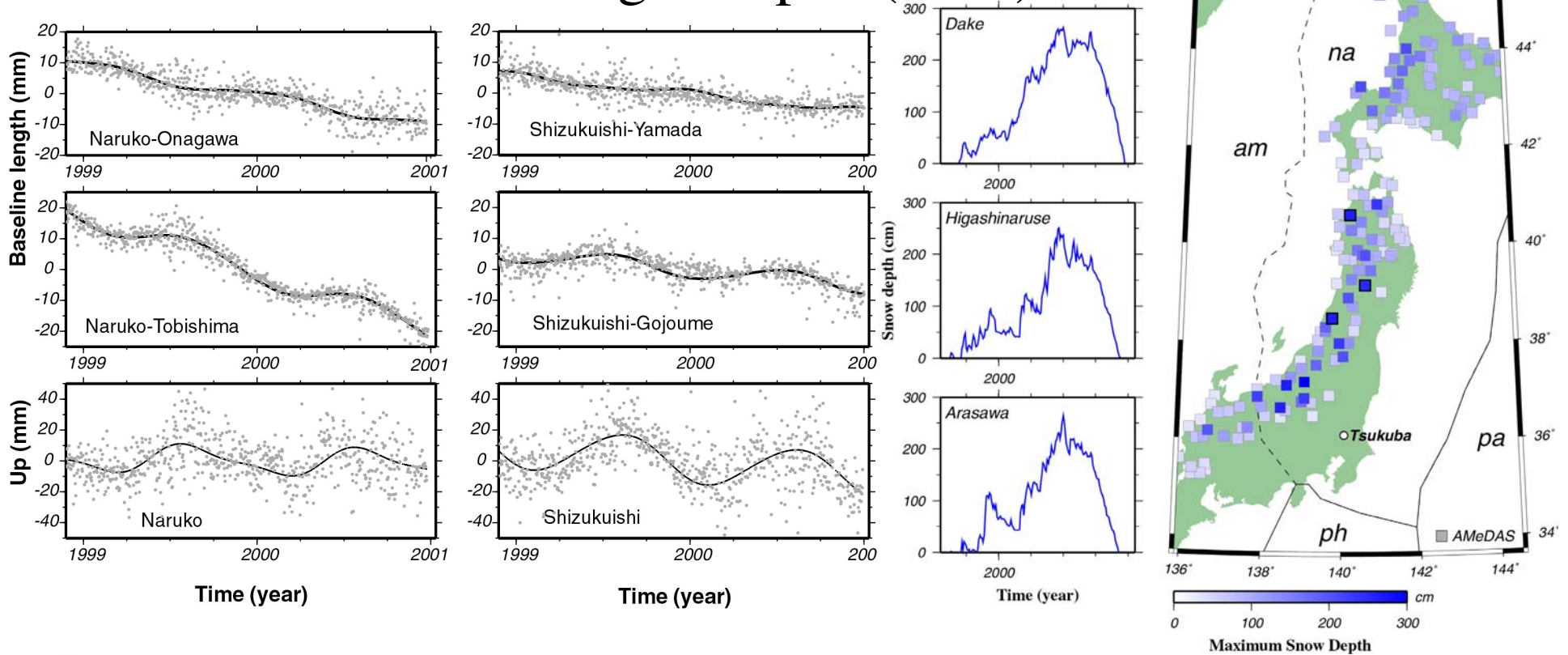

and in South-Central Chile (Bevis et al)

These vertical motions correlate with water volume changes in a lake located 20 km away from the GPS station

GRACE may detect a mixture of seasonal elastic loading signals and steady secular motions due to GIA

This project will address this possibility by adding CGPS stations near the Patagonian icefields as well as performing more survey GPS measurements so as to improve the resolution of secular rates of uplift

Bevis and Smalley will lead the GPS effort

Jerry Mitrovica, Rick O'Connell, and Erik Ivins will address the impact of probable lateral changes in the geomechanical character of Patagonia

John Wahr will help with the integration of the GRACE measurements

Geodetic Signature of Cryospheric Change

Erik R. Ivins*

Eric Rignot* Xiaoping Wu*

Thomas S. James‡ Gino Casassa‡

* JPL Caltech Pasadena, California, USA

‡GSC, Sidney, British Columbia, Canada

‡Centro de Estudios Científicos, Valdivia, Chile

GRACE Science C.S.R., Austin TX

Oct. 8-10, 2003

proposed work for the first year focus on:

- To directly search for optimized solutions for hydrological mass transport using combined GRACE and GPS data sets with input from other terrestrial and space-based constraints with emphasis on cryospheric change and mantle isostatic flow.
- To produce ancillary forward-inverse model products associated with postglacial rebound such as providing map-view predictions of Coulomb stresses within the Antarctic seismogenic crust which may be directly driven by time-dependent “flexing” of the lithosphere.

Antarctic mass balance of Rignot and Thomas (2002)

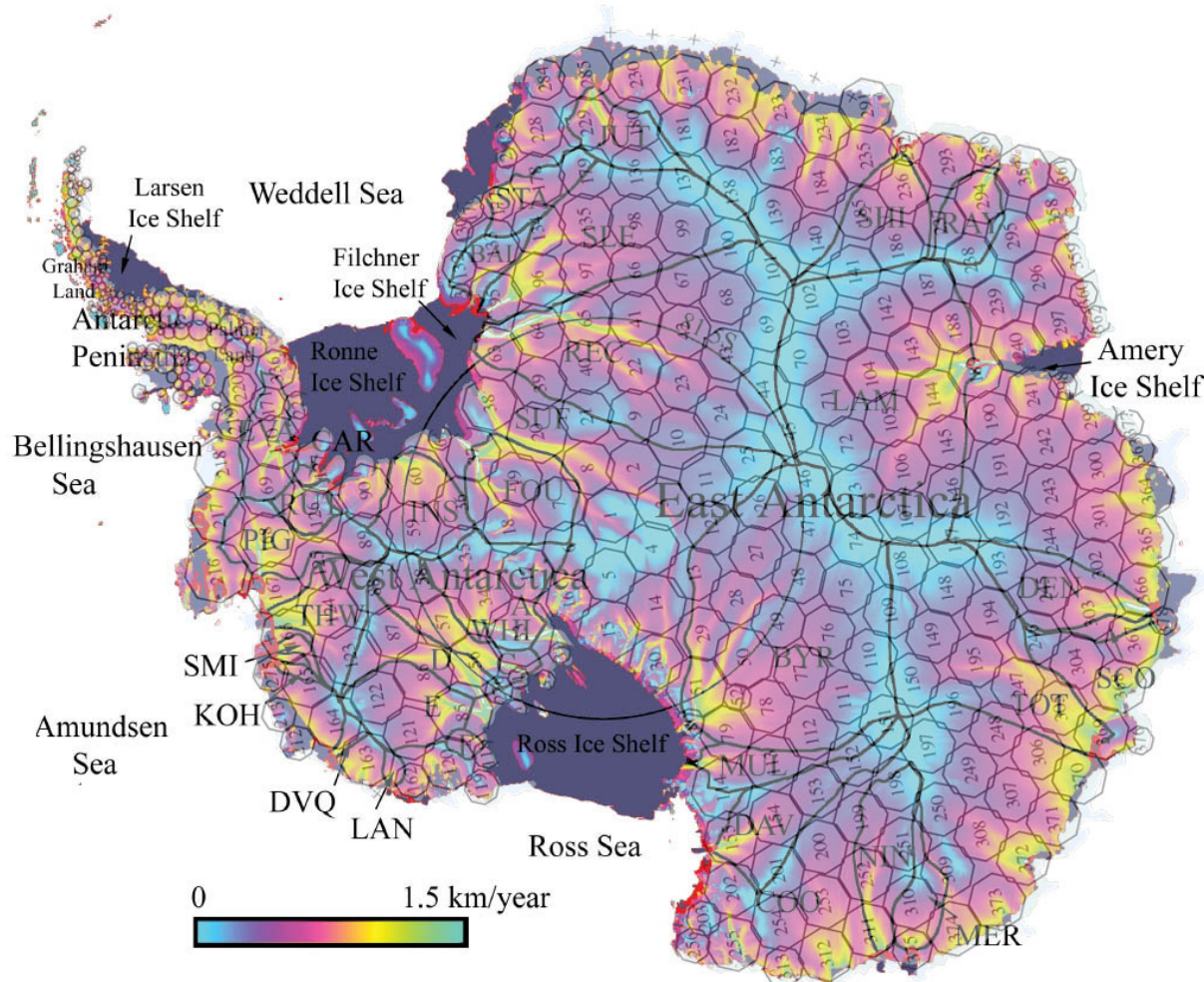

- $d\xi/dt \sim 0.1-0.2$ mm/yr
- Estimate Patagonia, Antarctic Peninsula, New Zealand
- Forward viscoelastic solid earth models predict both uplift and gravity change
- Uncertainty in the last 2 kyr BP evolution and in mantle viscosity

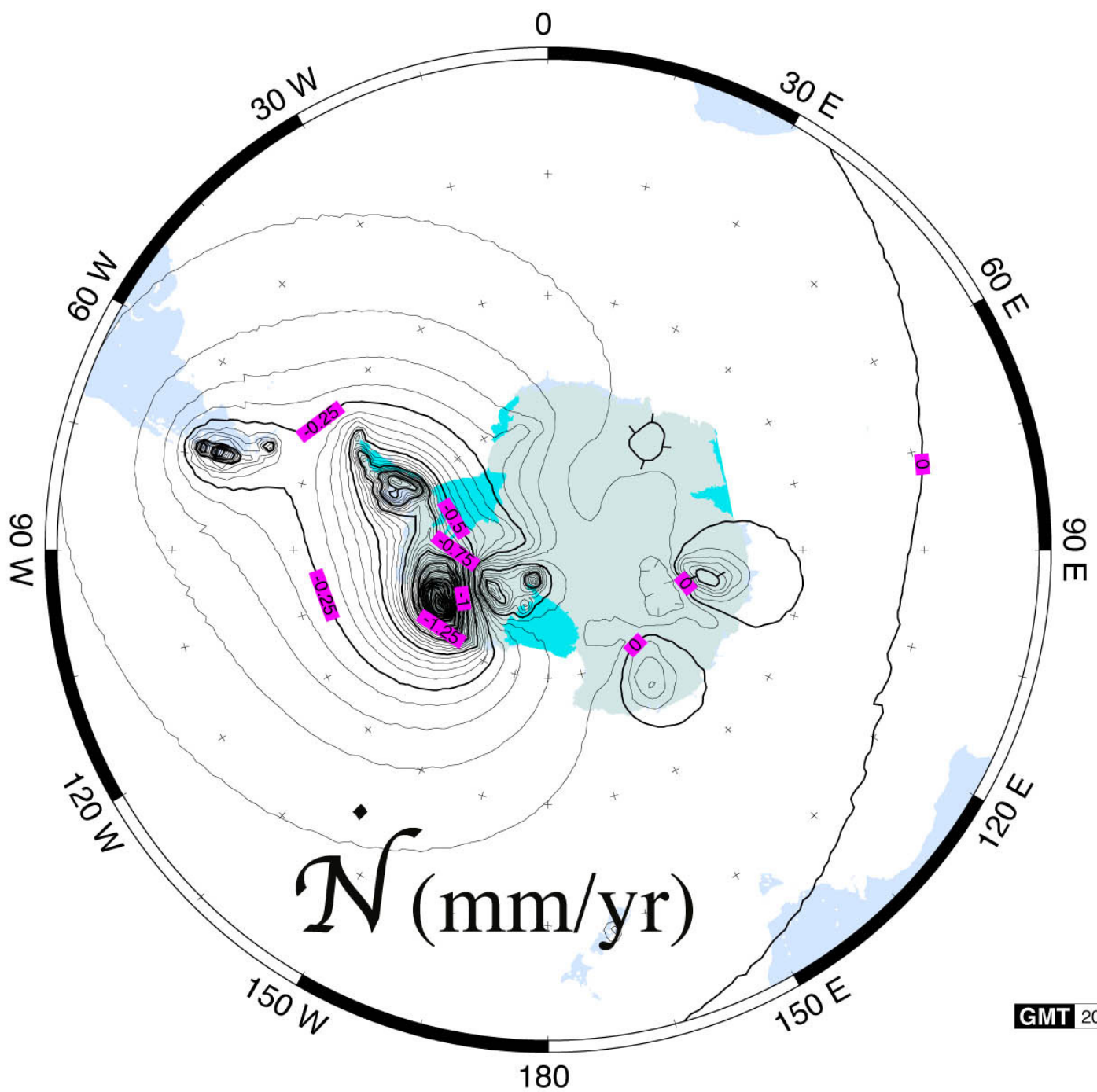

GMT 2003 Jan 26 15:24:54

uplift rate (mm/yr) -- present day deglaciation + PGR response

GMT 2003 Apr 22 19:11:52

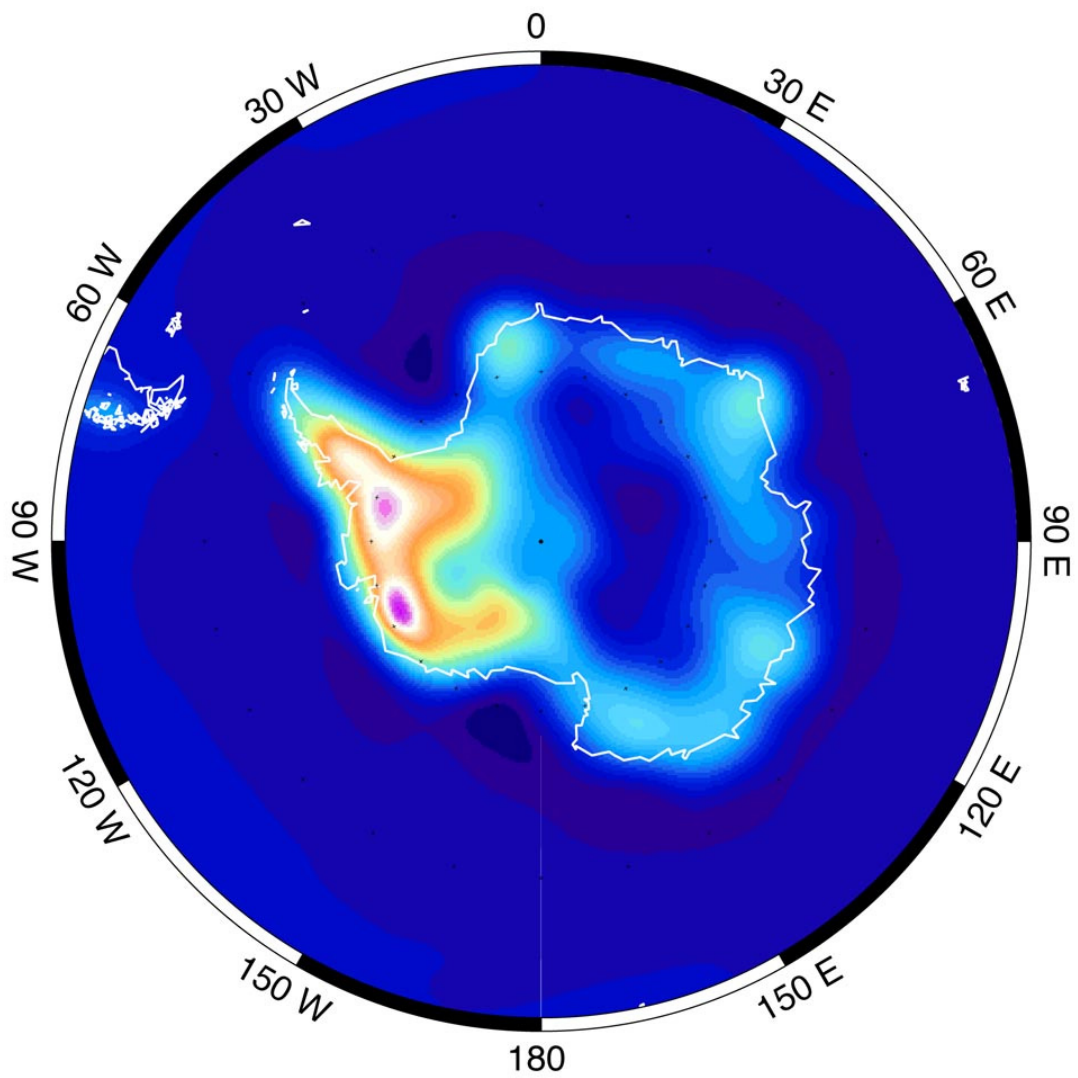

dw/dt (mm/yr)

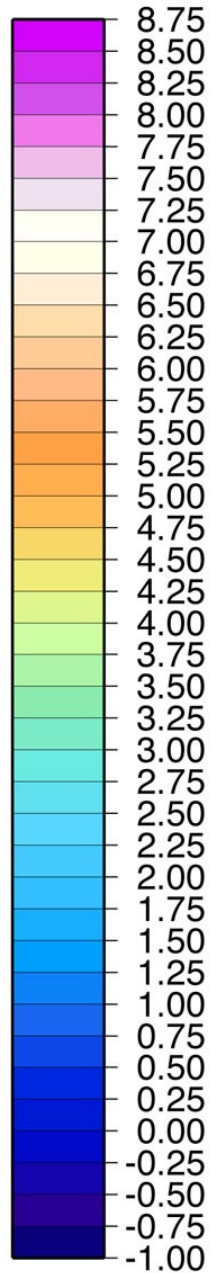

Southern Hemisphere rate of change in geoid due to PGR and present-day glacial change

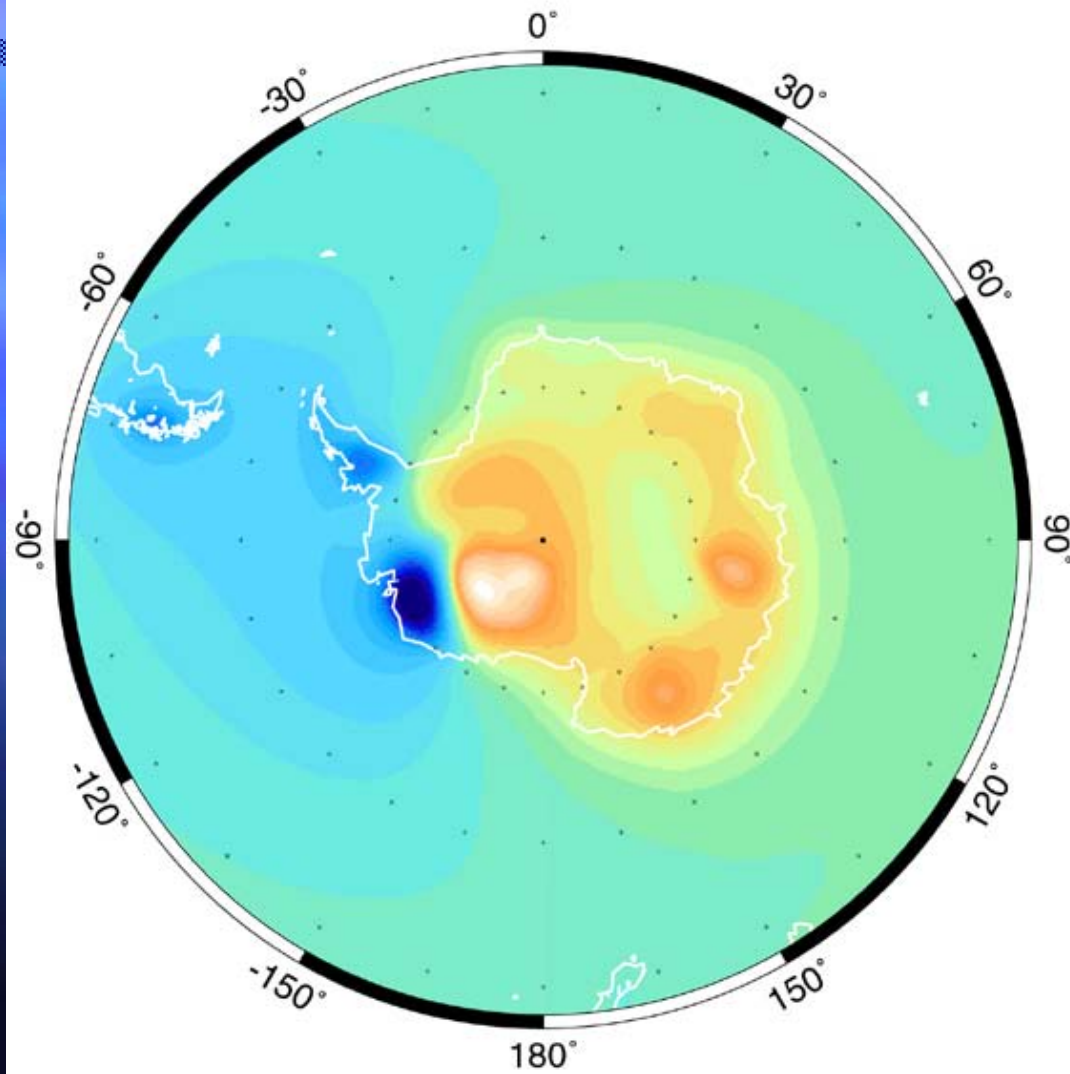

ΔN (mm/yr)

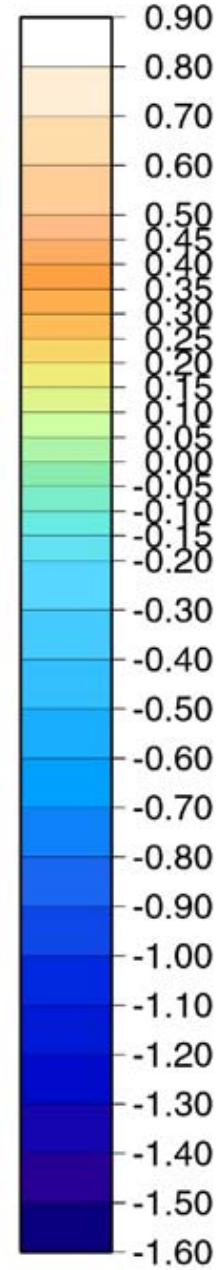

Antarctic and Global (ICE3G) Rebound Spectra

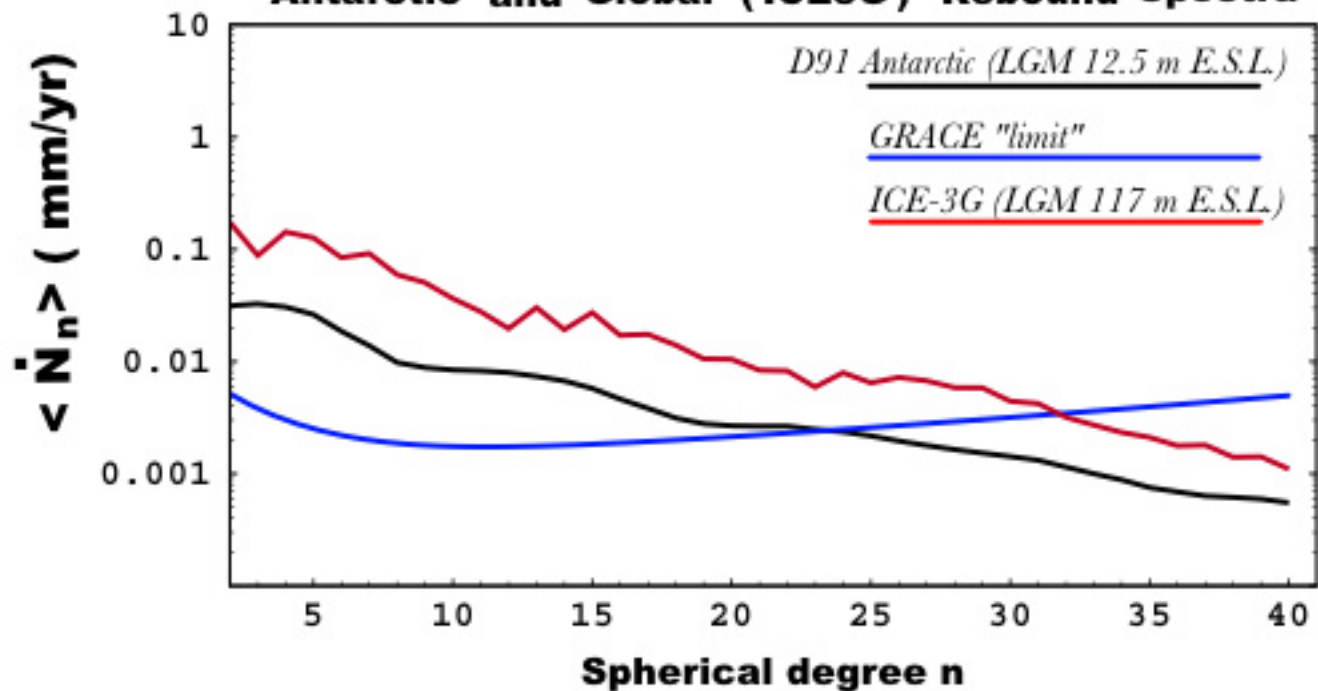

Cryosphere Change Power Spectra

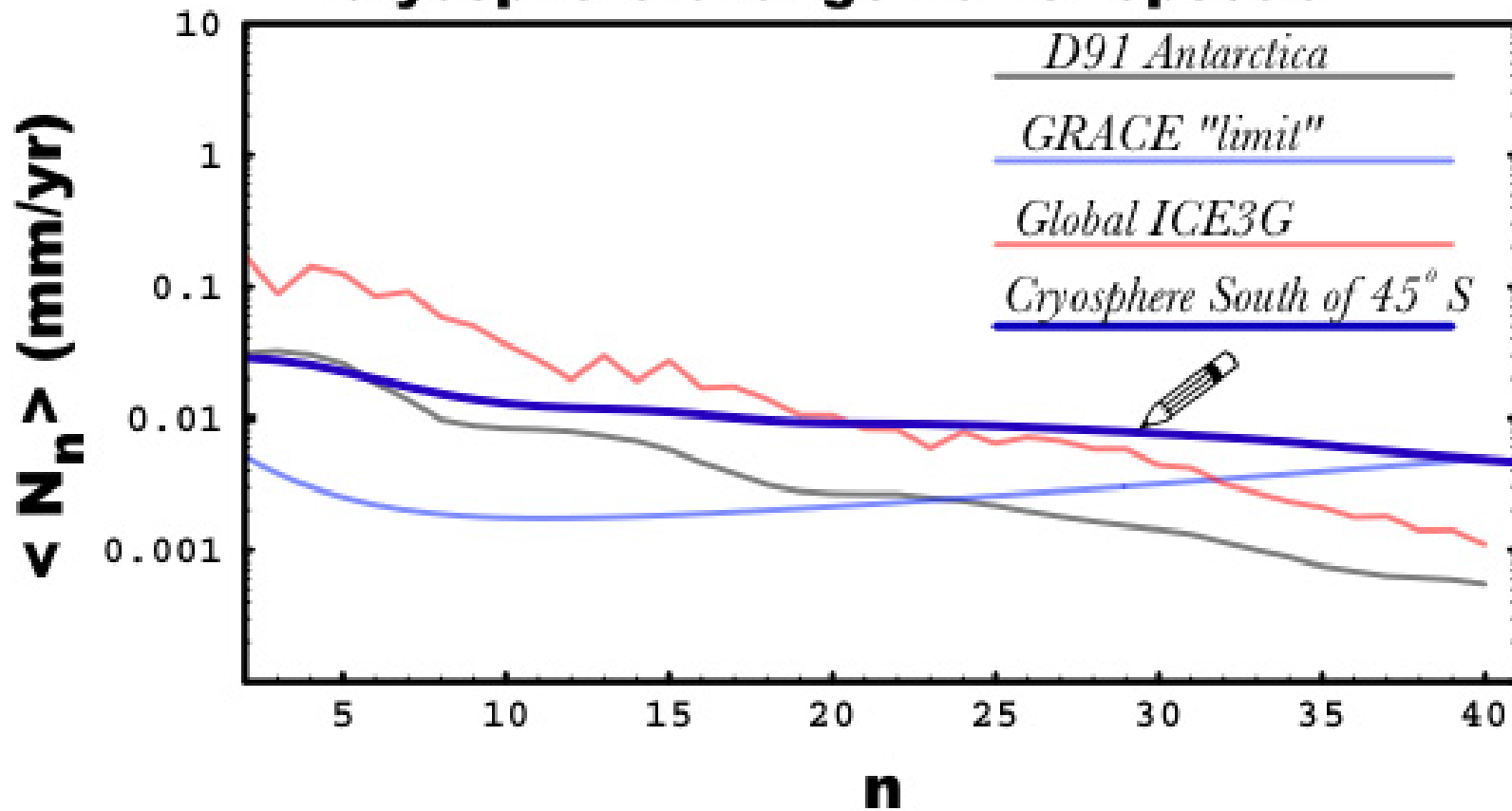

“smaller” glacier systems can make large contributors to present-day sealevel rise

Glacier cap & mtn. system (units in 10^3 km^2)

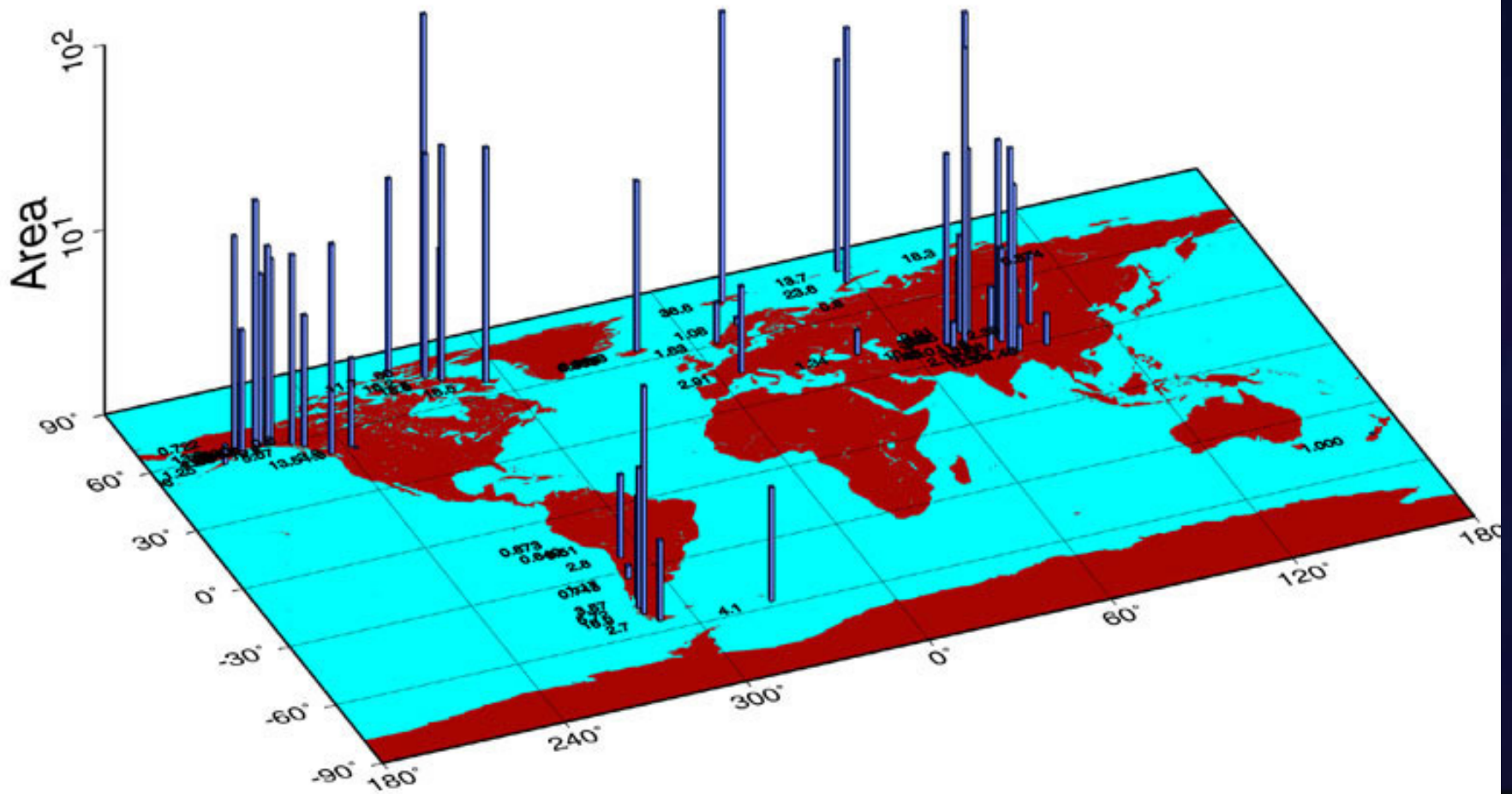

Temporal Geoid: Alaskan glacier demise

Tamisiea, Mitrovica & Davis, EPSL (2003)

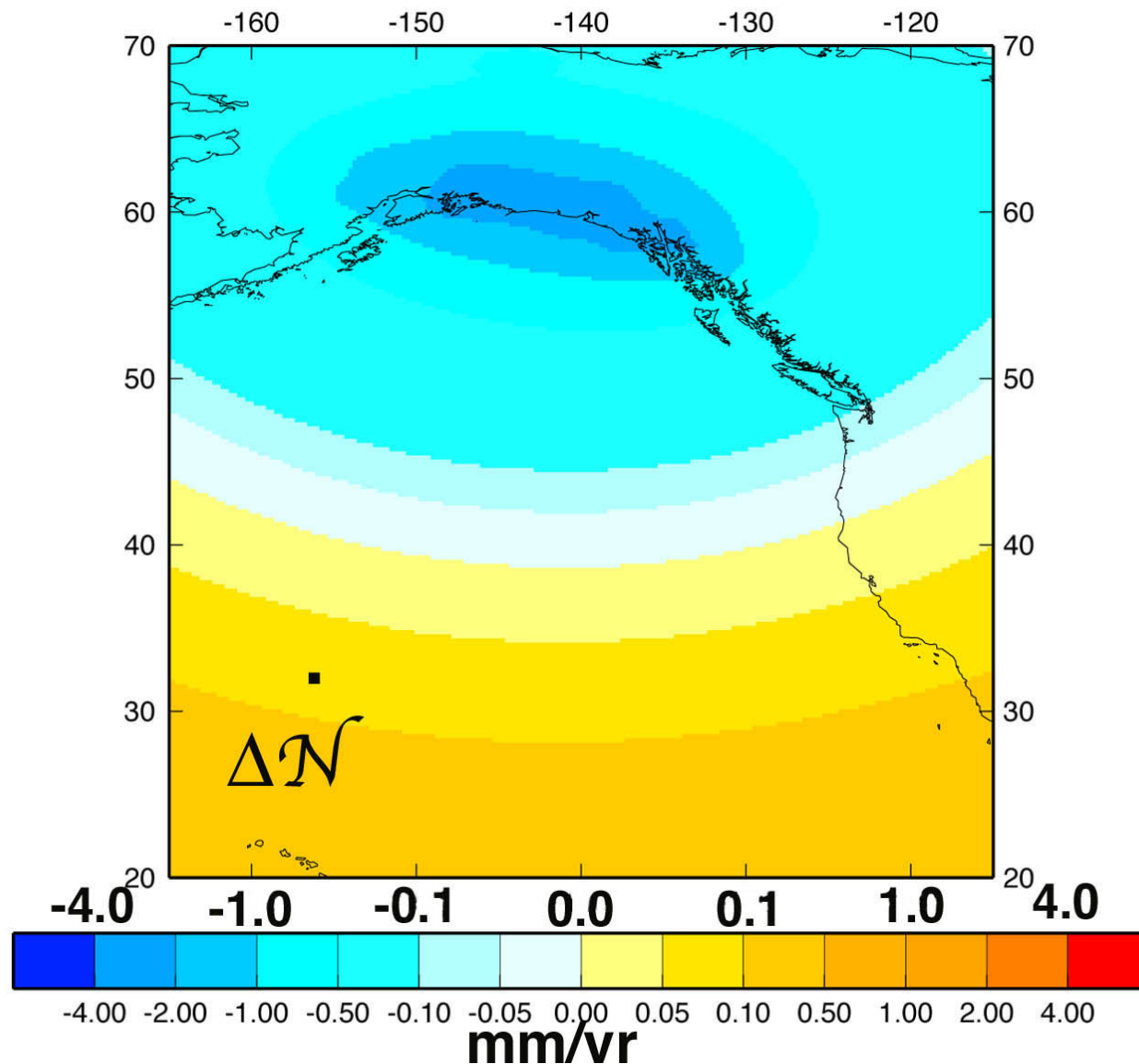

Regional Glacier Collapse and Geodetic Measurements: Alaska

Larsen et al., GJI, 2003 submitted

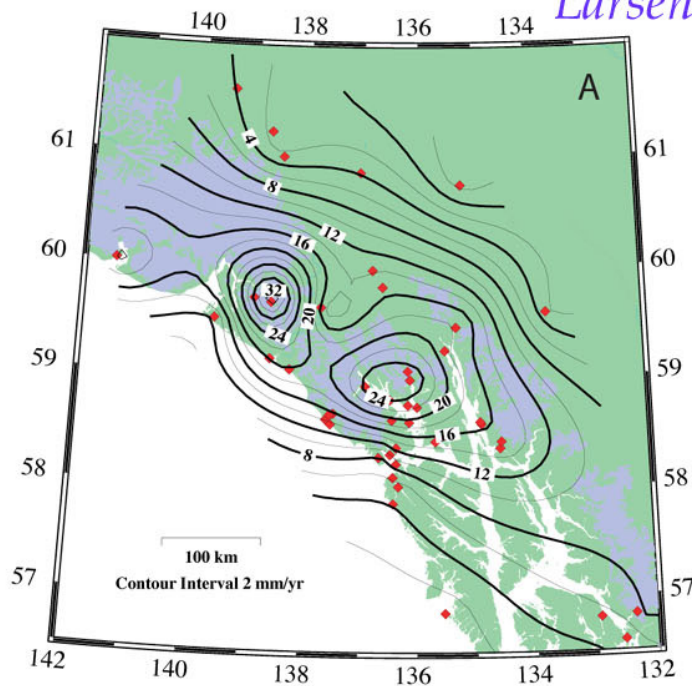

GPS determined uplift

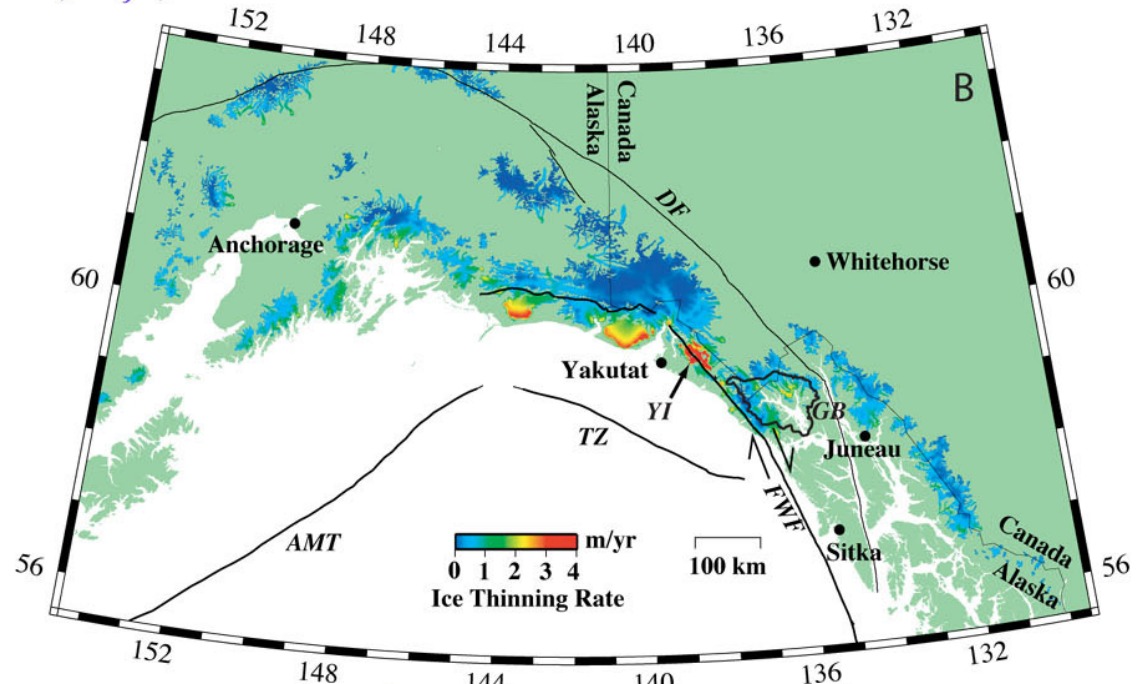

ice loss measurements

U.S. component of ITASE-Ice Coreing: 1999-present

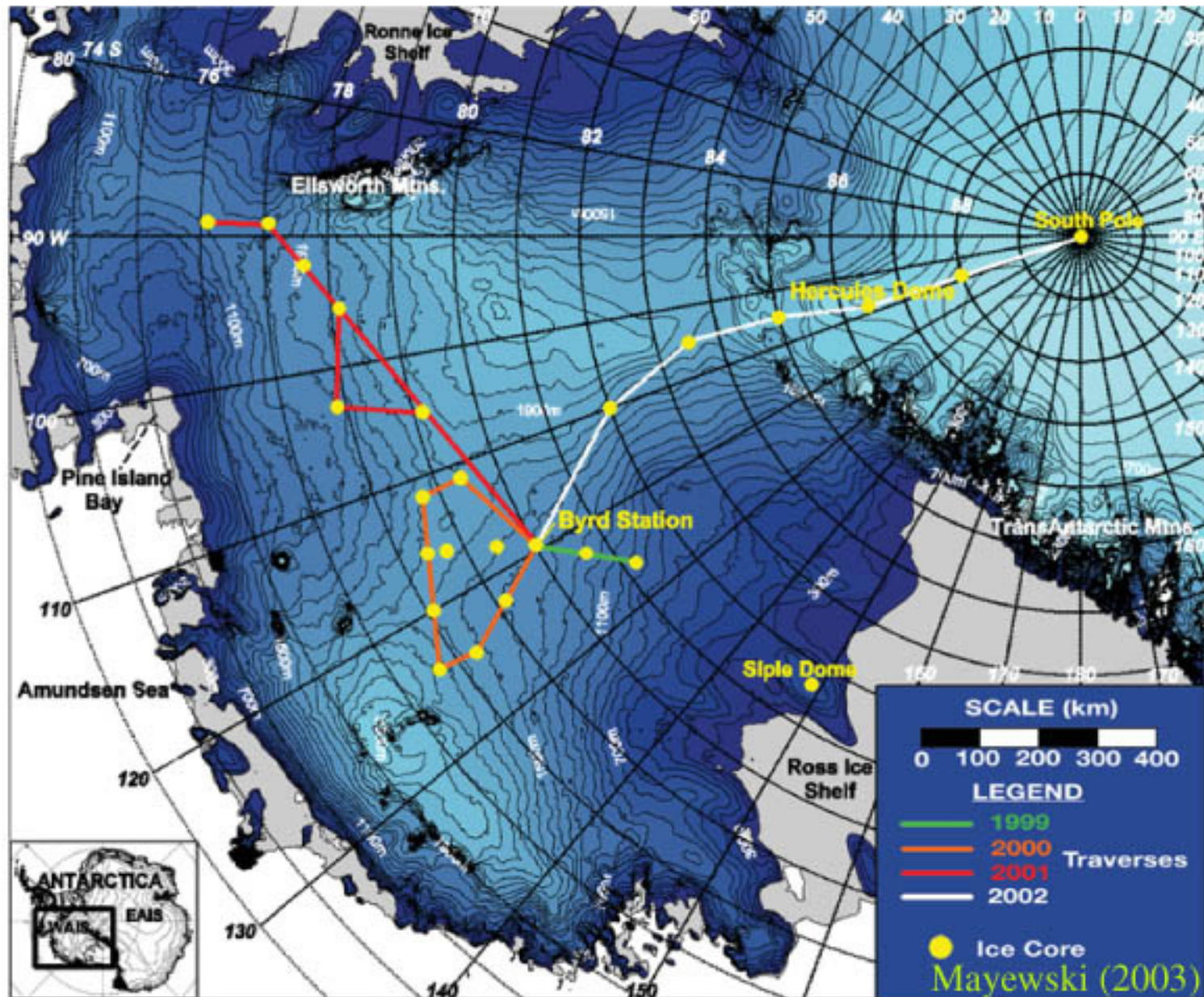

GGM01C (Satellite + TEG4) L = M = 200

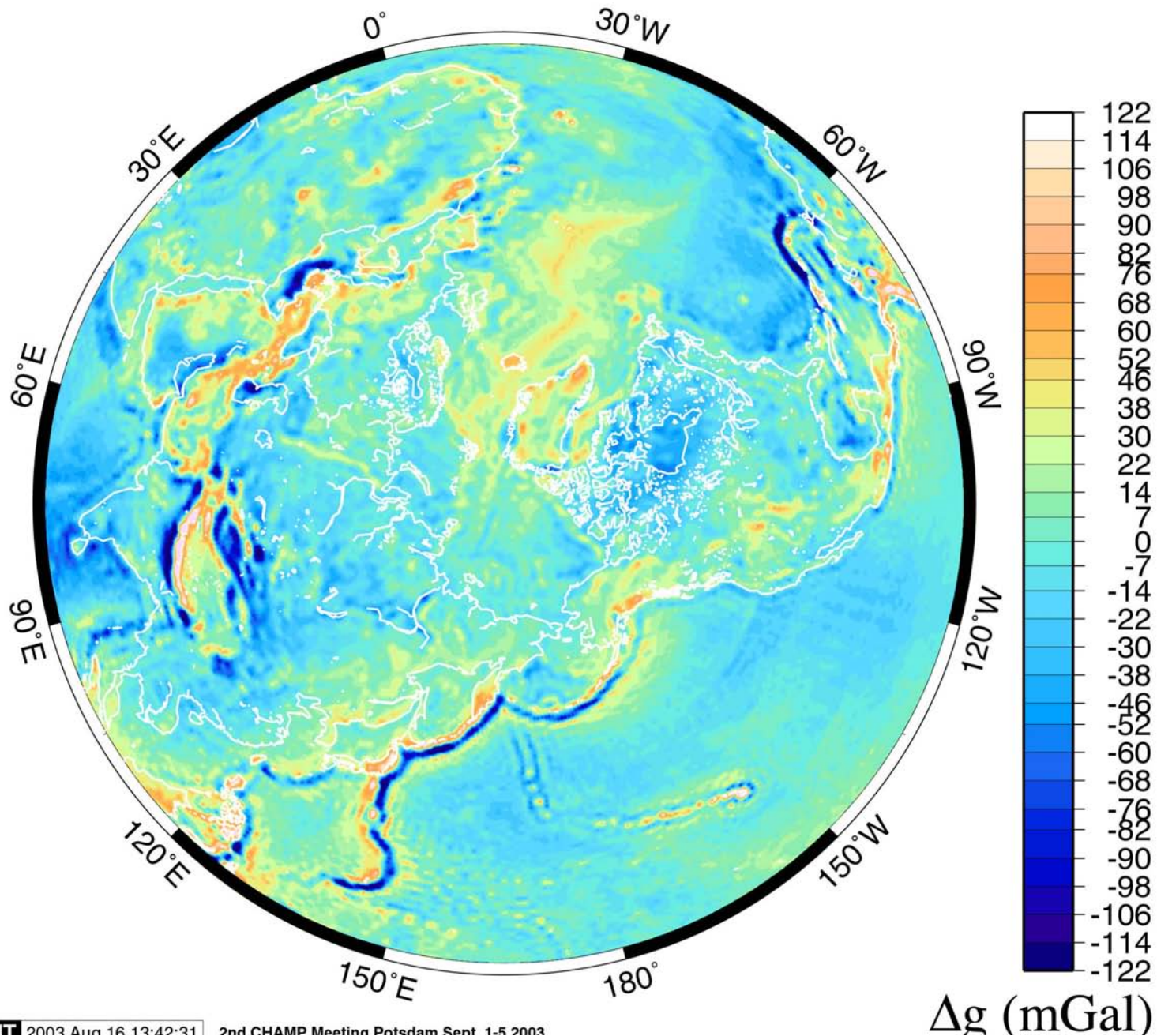

Antarctic continent: poorly constrained !

ANTARCTIC DIGITAL GRAVITY SYNTHESIS

DATA COVERAGE

<http://data.ldeo.columbia.edu/adgrav/>

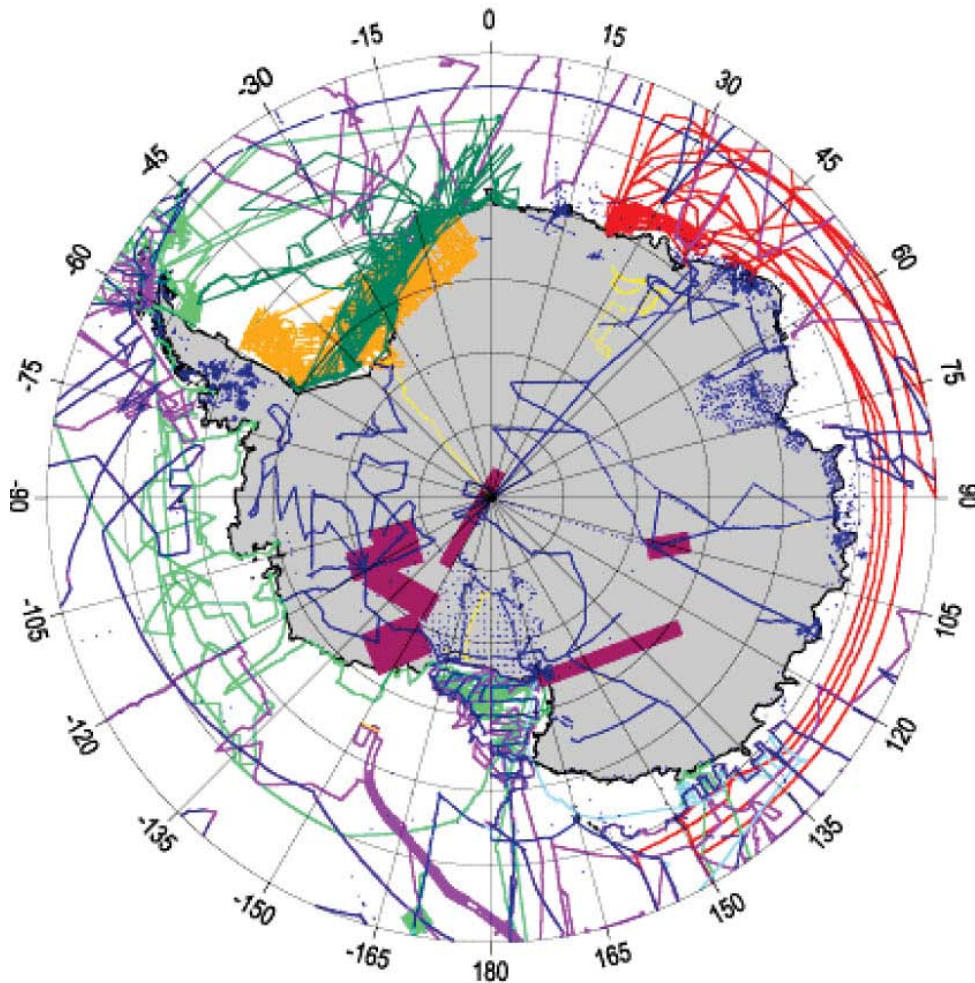

- CHAMP + GRACE + GOCE contribution
- GRACE possibly is at full power at 90 ($\lambda \sim 450$ km)
- Static rebound, or “ghost”, signature search is quite premature

GRACE Science C.S.R., Austin TX

Oct. 8-10, 2003

GRACE GGM01S 120 Static Anomaly Map in mGals (truncated at 90)

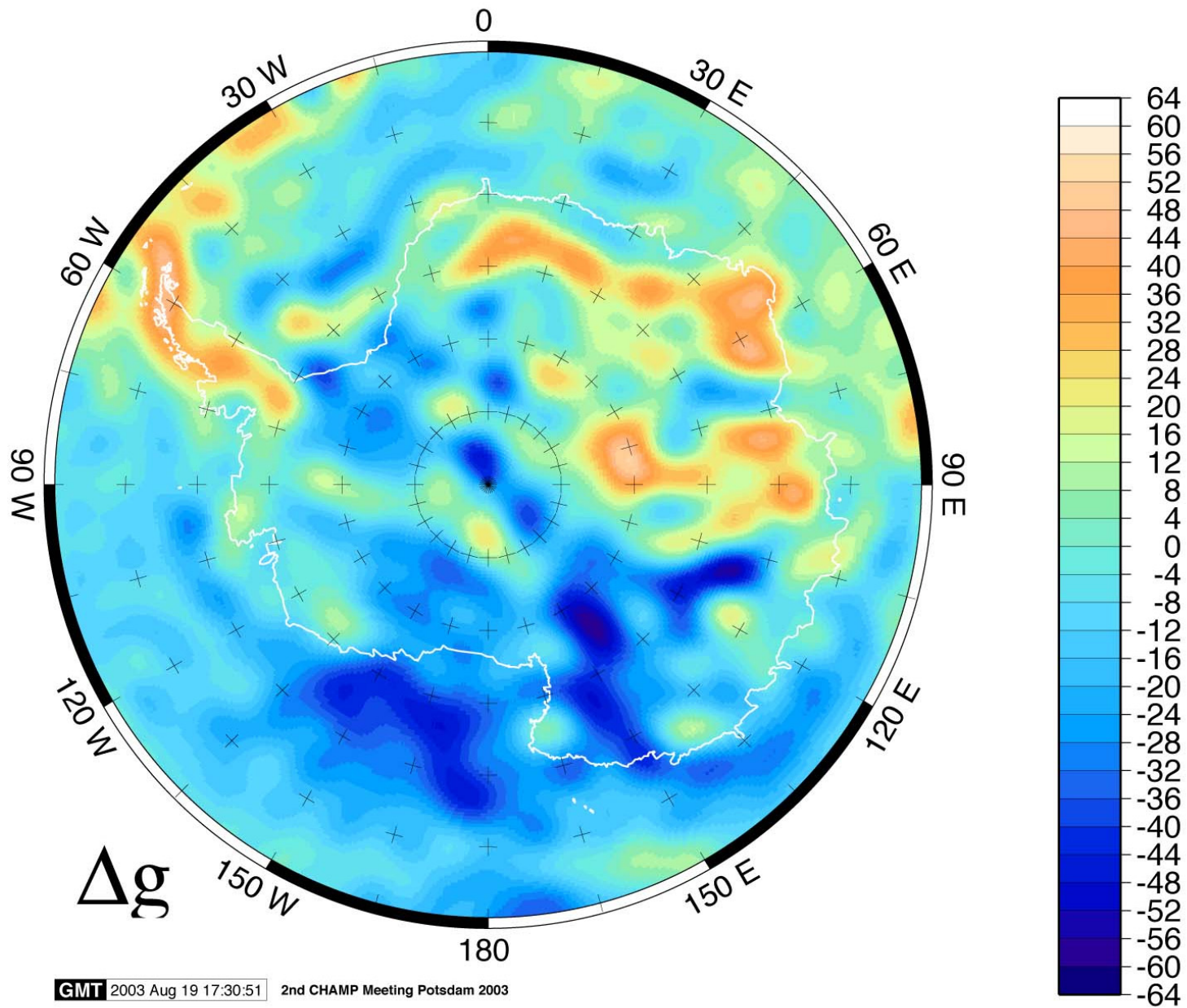

Modeled uplift data D91-1.5 ice model (Raymond et al., 2003)

Mt. Coates, Dry Valleys, Antarctica, up/lo mantle vc: 2.5

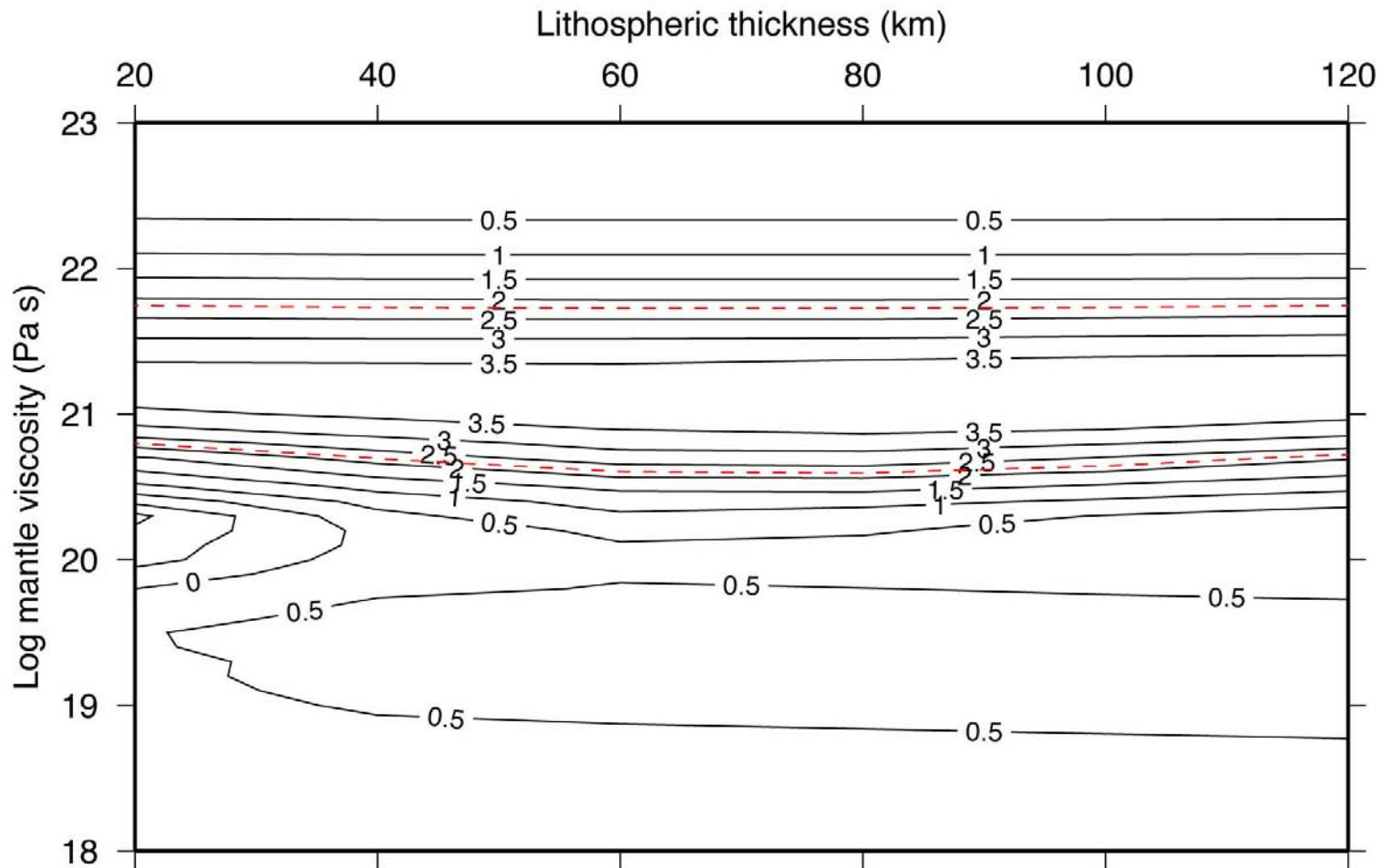

GRACE satellite 120 state / monthly map in mGal (truncated at 70)

GGM01S (L = M = 70)

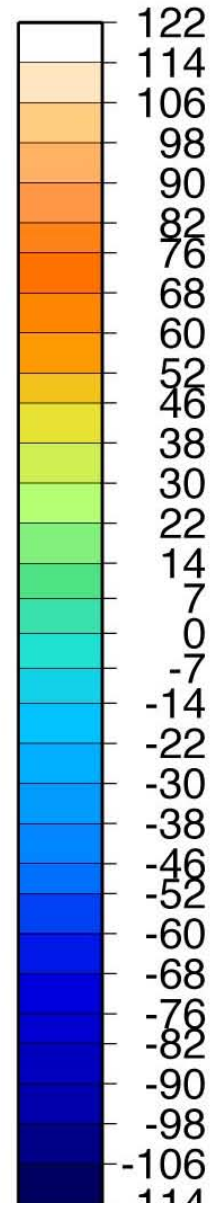
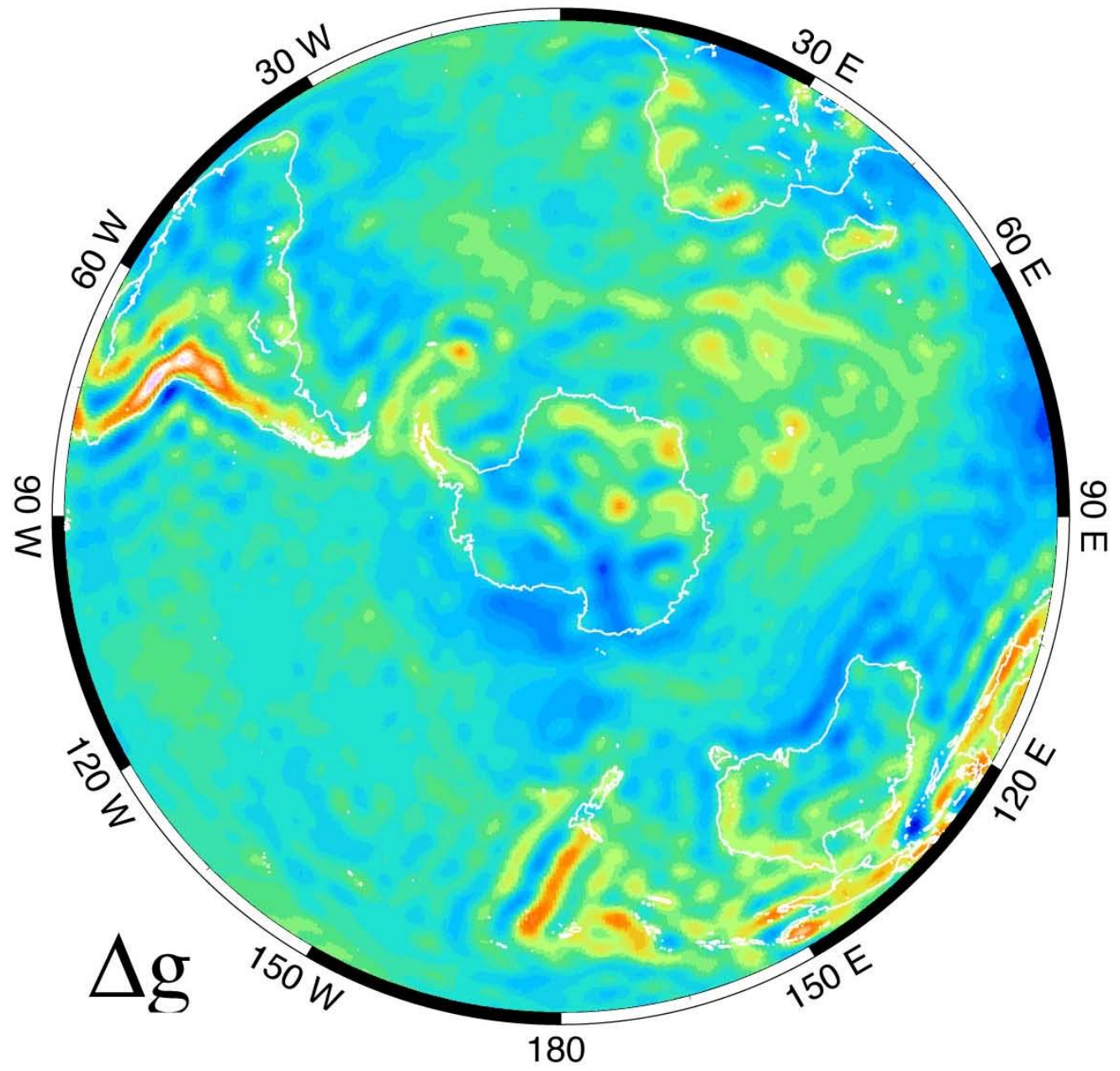

Δg

122
114
106
98
90
82
76
68
60
52
46
38
30
22
14
7
0
-7
-14
-22
-30
-38
-46
-52
-60
-68
-76
-82
-90
-98
-106
-114

Airborne Mapping: West Antarctica

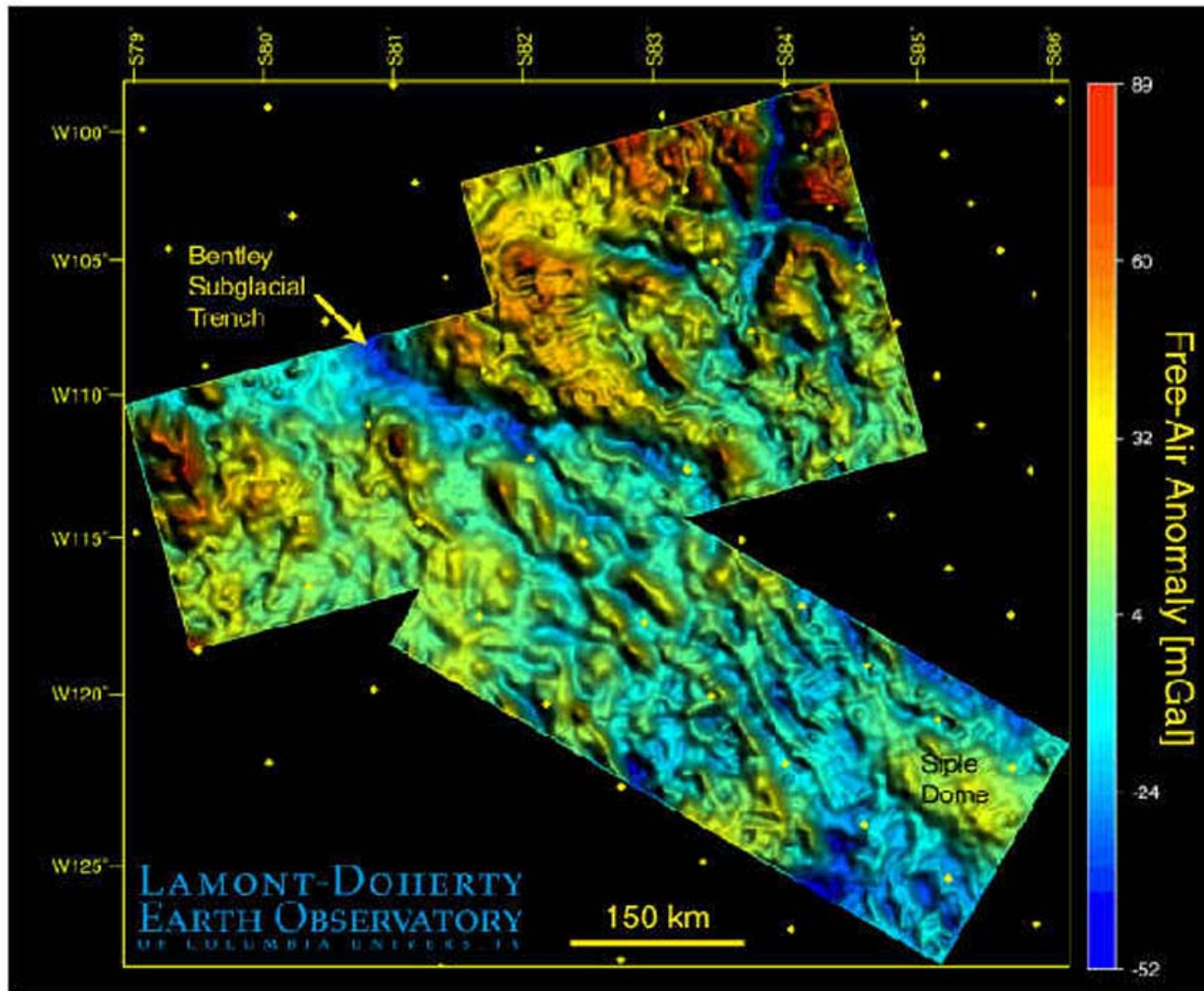

proposed work for the 2nd-3rd years :

- To produce 30-year time-average secular rate of change estimates for the Stokes coefficients of the gravity field associated with the individual mass change contributions. The sources/sinks of sea-level change include:
 - i. Antarctica, with subdivision into major drainage basins,
 - ii. Greenland, separated into 4 sub-regions
 - iii. Each of the continents, Africa, North and South America, Eurasia, Australia and Southeast Asia and archipelagos,
 - iv. Postglacial rebound with an uncertainty budget
 - v. Sea-level change, with eustatic and non-eustatic self-gravitational components and to bridge the LAGEOS-class gravity change data, with its 26-year long data record, and the upcoming GRACE 5-year, high-resolution, data sets.
- To provide estimates of the gravitational self-attraction between ice and ocean masses, as these are important for the interpretation of geoid and sea-level changes monitored by the Topex-Poseidon and Jason altimetry missions.
- To provide a map-view set of predictions of the gravity change, gravity change gradient and 3-D crustal motions for example as associated with high resolution studies of glacier change and mantle-lithospheric rebound in Patagonia, Antarctic Peninsula, etc.

High Accuracy Gravimetric Geoid for Arctic Research from GRACE....

D. McAdoo* and V. Childers***

S. Laxon**, C. Wagner*, J. Brozena***, et al

*NOAA, **UCL, ***NRL



GRACE Science Meeting
October 8-10, 2003

Outline

1. Introduction and background.

Status of detailed gravity in the Arctic
International ArcGP Gravity Project.

ERS altimetric marine gravity

Motivation: need for a precise Arctic Ocean geoid.

2. Statistical and spectral comparisons (ArcGP as benchmark)

3. Geoids for Arctic oceanography

4. Summary

Detailed Arctic Models

Arctic Ocean ERS Gravity

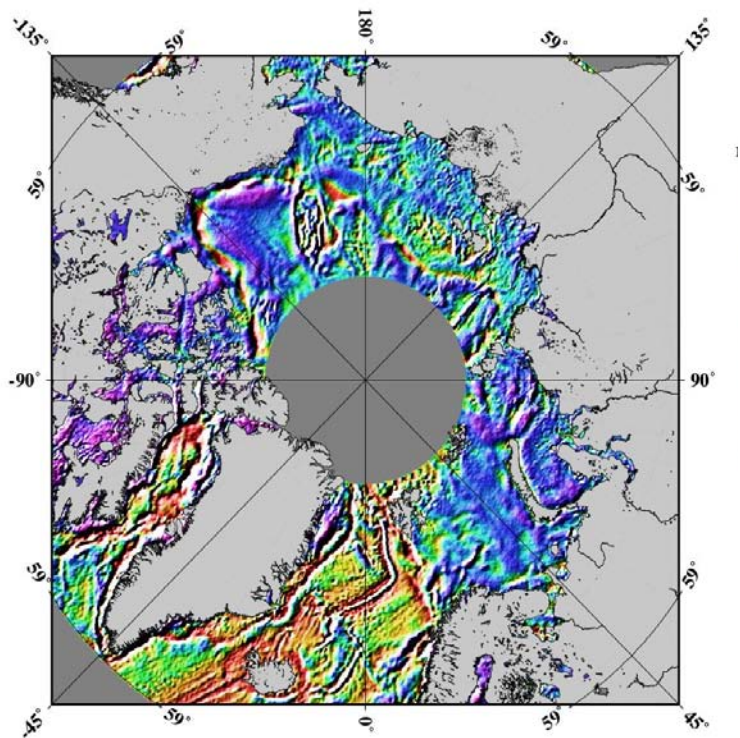

Arctic ArcGP Gravity

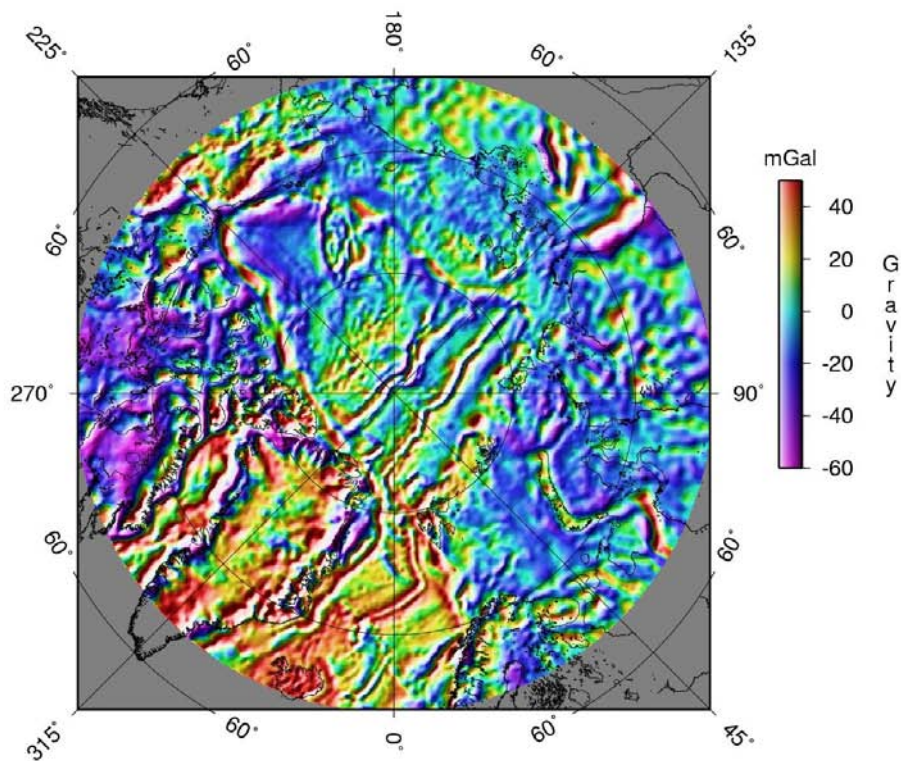

GRACE Satellite Gravity vs Arctic Bathymetry

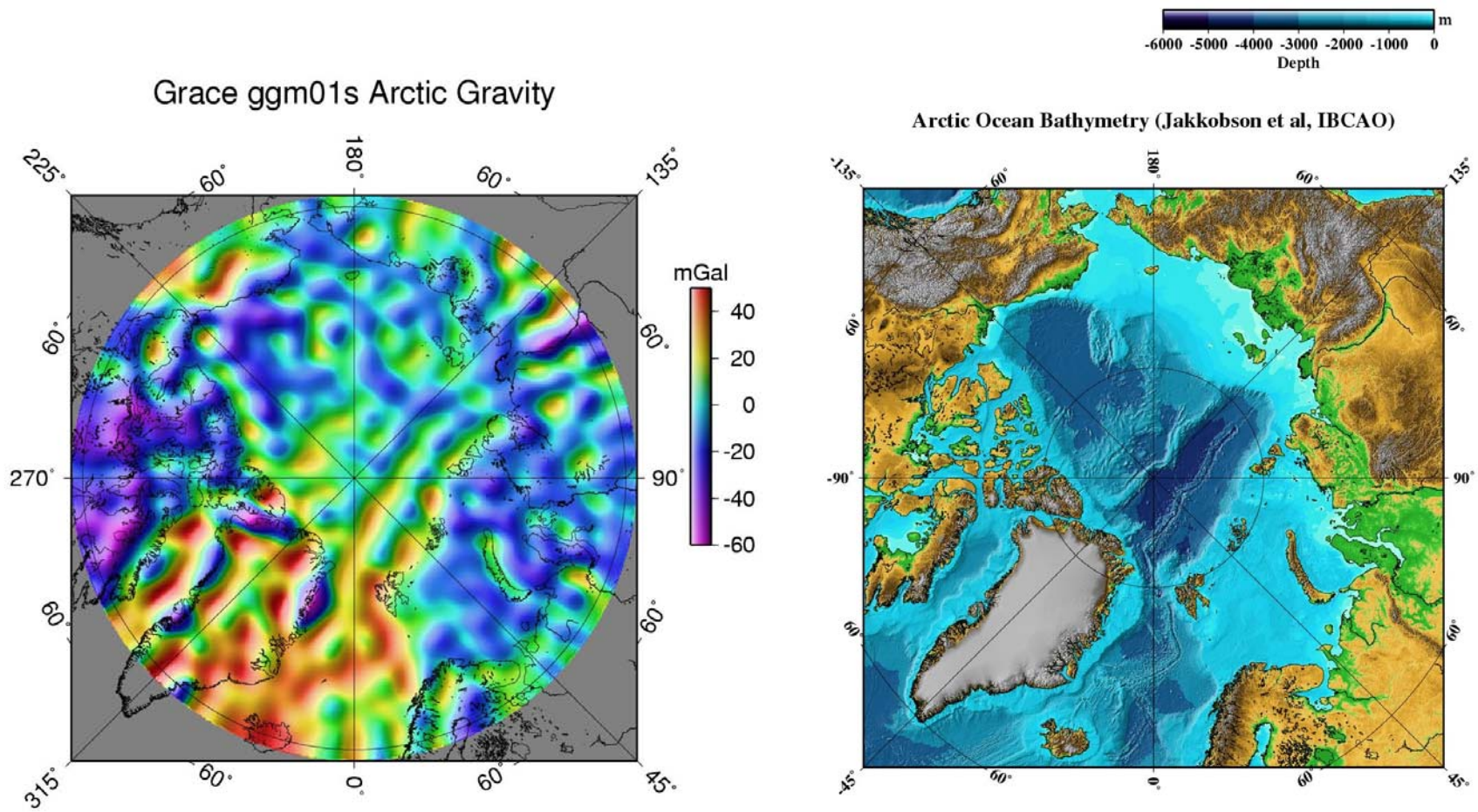

Gravity: Low-pass Filtered with 2.5-degree Gaussian

Note the high correlation
corr coefficient = 0.987

ArcGP Gravity (filtered-2.5)

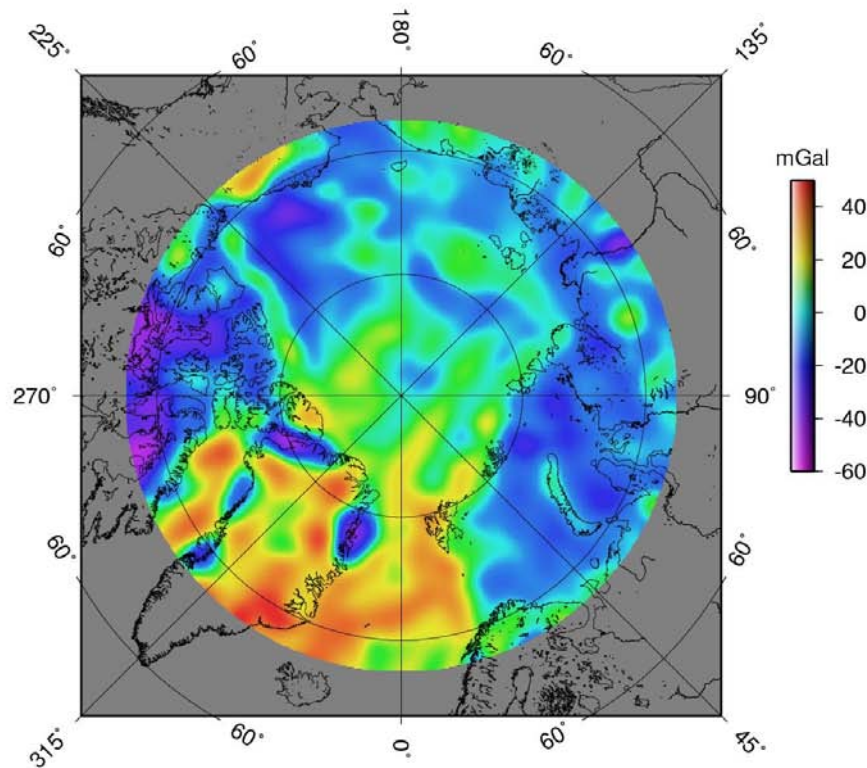

GRACE GGM01S Gravity (filtered-2.5)

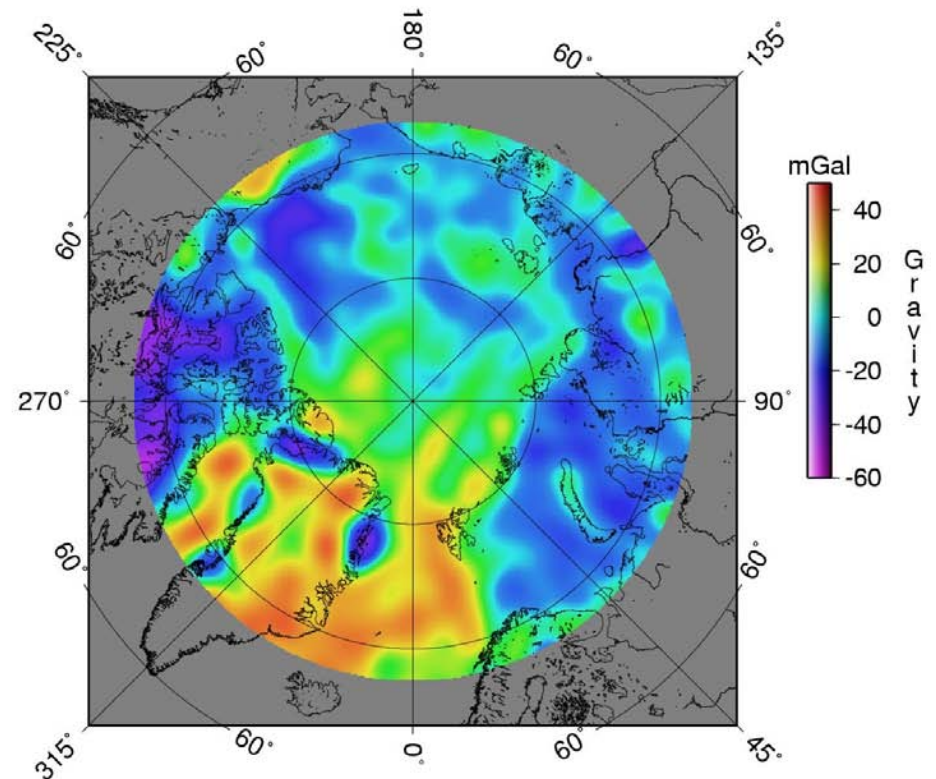

Correlation Coefficients

ArcGP Arctic Gravity versus:

GRACE (GGM01S) 0.9873
GRACE (EIGEN-GRA) 0.9856

CHAMP (PGS-7772) 0.9090
CHAMP (TUM-1S) 0.8863
CHAMP (EIGEN-2ee) 0.8613
CHAMP (EIGEN-2) 0.8167
CHAMP (UCPH) 0.8073

vs other global models:

Satellite(EGM96S) 0.7803
Surface(EGM96gr) 0.9504 (lower than GRACE!)

**All fields have been low-pass filtered with 2.5 degree gaussian

Filtered GRACE & CHAMP Gravity: Differenced with ArcGP Arctic Model

GGM01S - ArcGP (2.5-deg filtered) Gravity

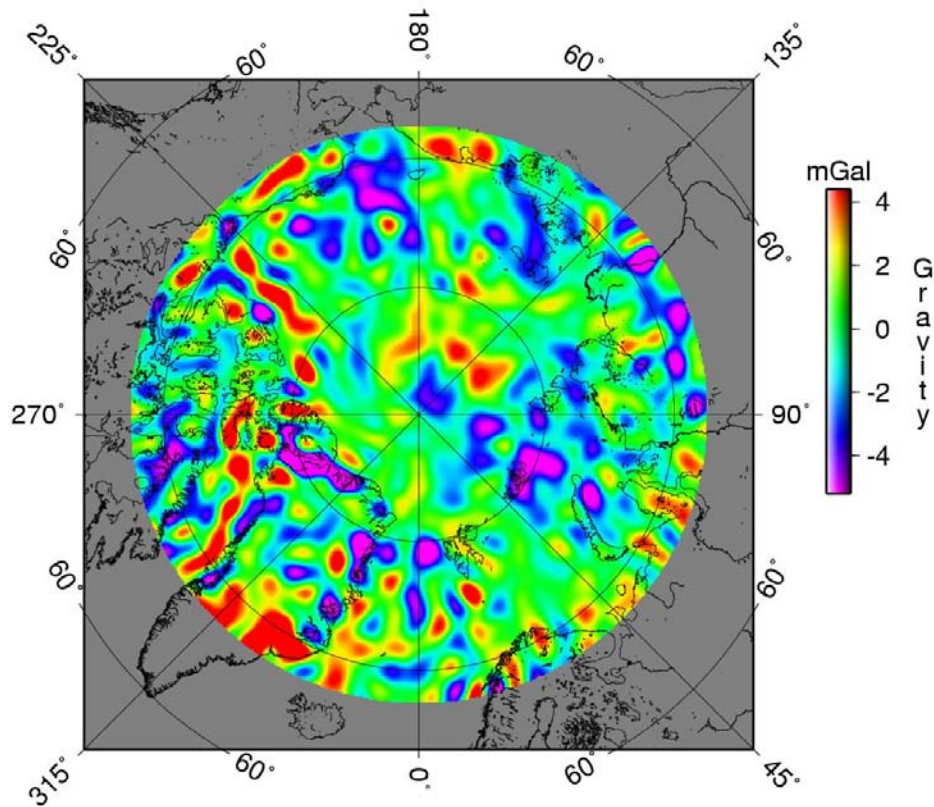

RMS = 2.34 mGal

CHAMP-PGS772 - ArcGP (2.5-deg filt) Gravity

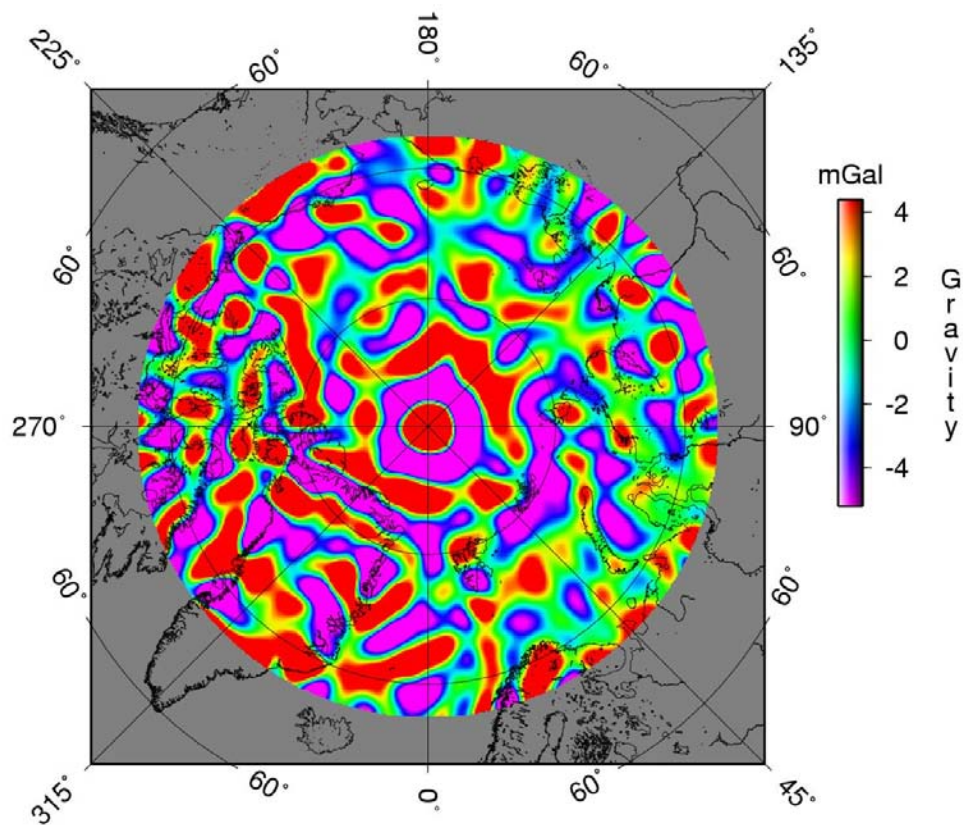

RMS = 5.69 mGal

Residual RMS Differences between ArcGP Arctic and Satellite Models**

	GRAVITY RMS Difference(mGal)	GEOID RMS Differences(m)
GRACE (GGM01S)	2.34	0.35 m
GRACE (EIGEN-GRA)	2.47	0.36
CHAMP (PGS-7772)	5.69	0.59
CHAMP (TUM-1S)	6.29	0.664
CHAMP (EIGEN-2ee)	6.86	0.696
CHAMP (EIGEN-2)	8.02	0.778
CHAMP (UCPH)	8.31	0.993
vs other global models:		
Multi-Sat(EGM96S)	8.24	0.995
Surface(EGM96gr)	3.43	1.04
GRACE (GGM01C)	--	0.31

**All fields have been low-pass
filtered (2.5 degree gaussian)

Hybrid Geoid

GRACE at long wavelengths and ArcGP at short ones

Transition wavelength ~ 650 km

GRACE(ggm01s) Arctic Geoid

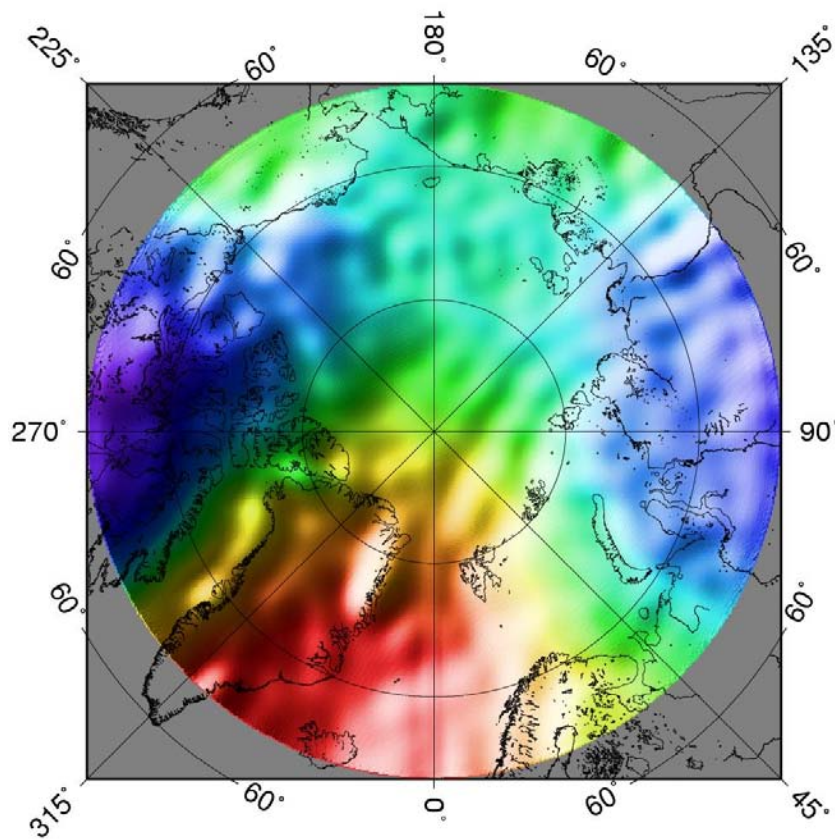

GRACE-ArcGP hybrid Geoid

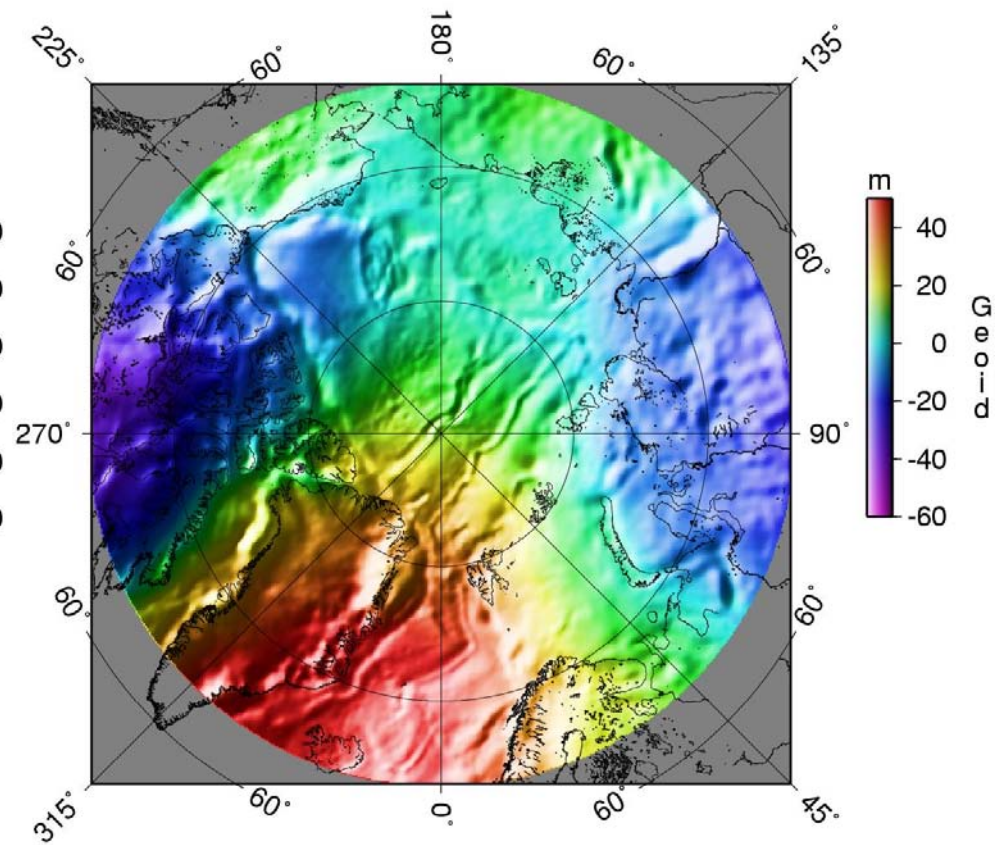

Mean Sea Surface (MSS) minus Geoid: Dynamic Topography?

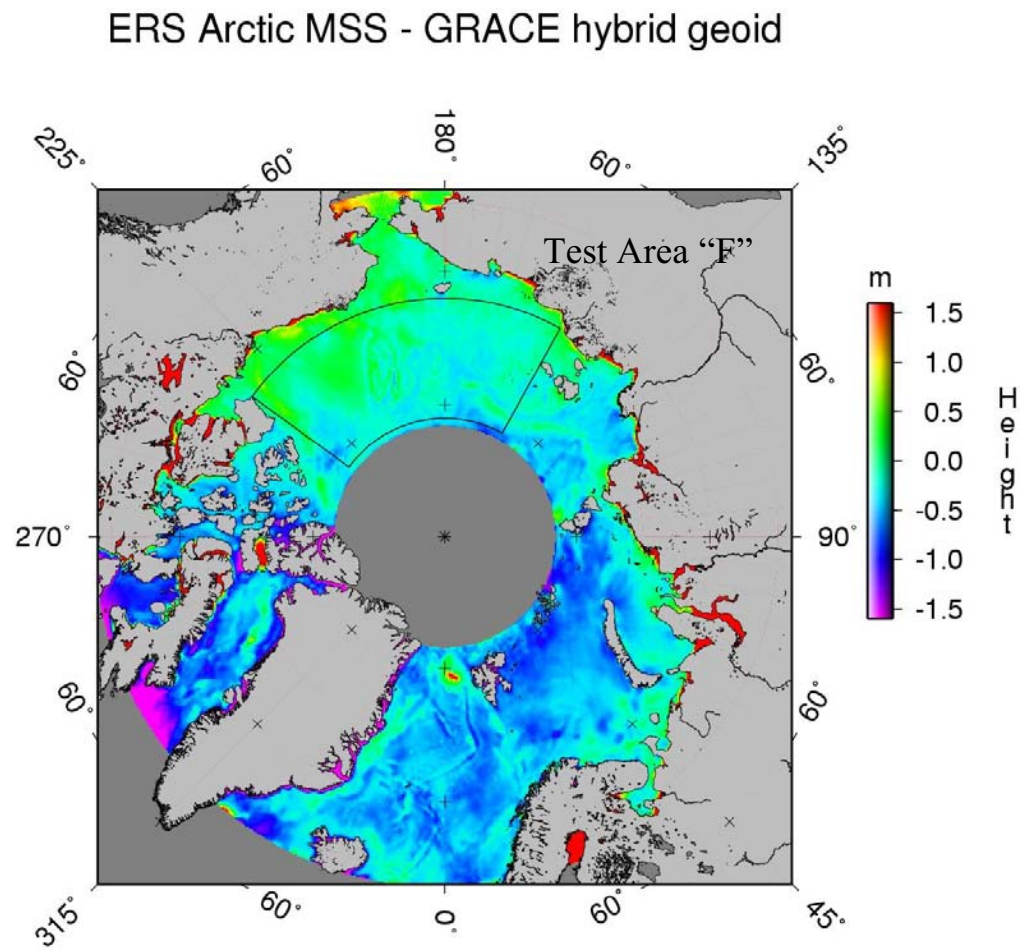
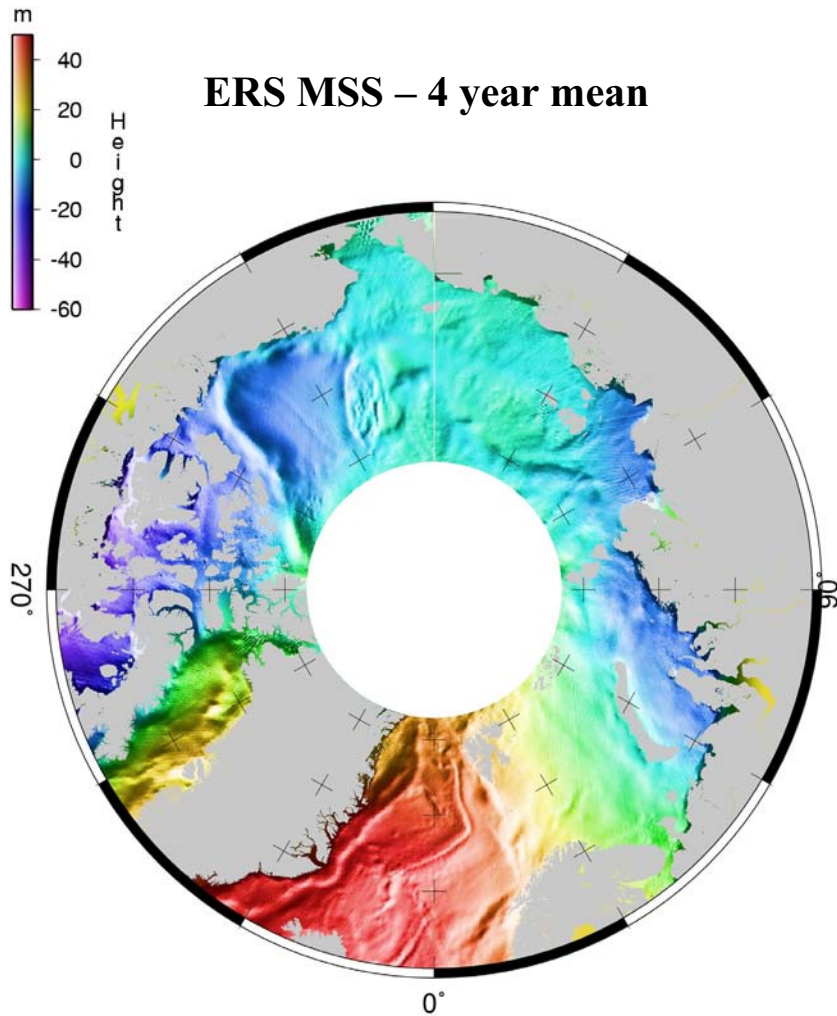

RMS Difference: ERS MSS minus Geoid
in Area F [all(!) wavelengths]

GEOID -----	RMS Difference (cm) -----
GRACE	36.1
ArcGP	26.7
G-A Hybrid	18.8

ERS MSS minus the ArcGP Arctic Geoid

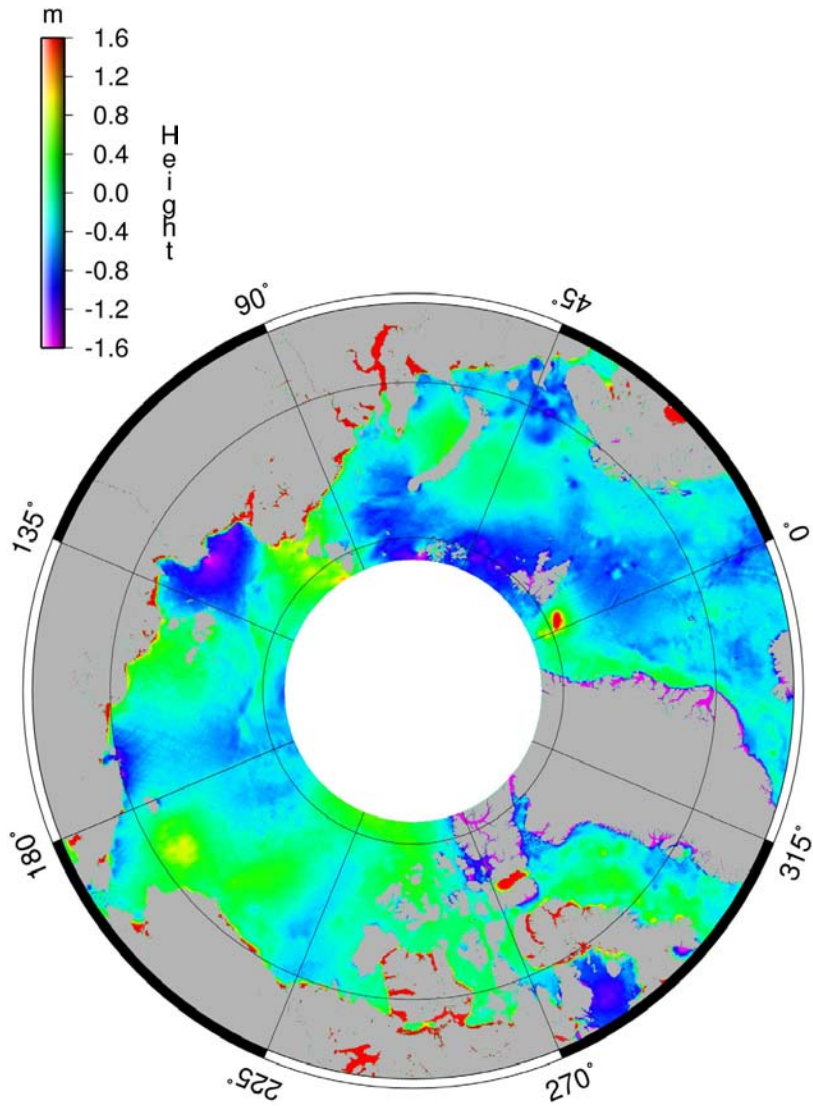

Dynamic topo from Navy PIPS Model

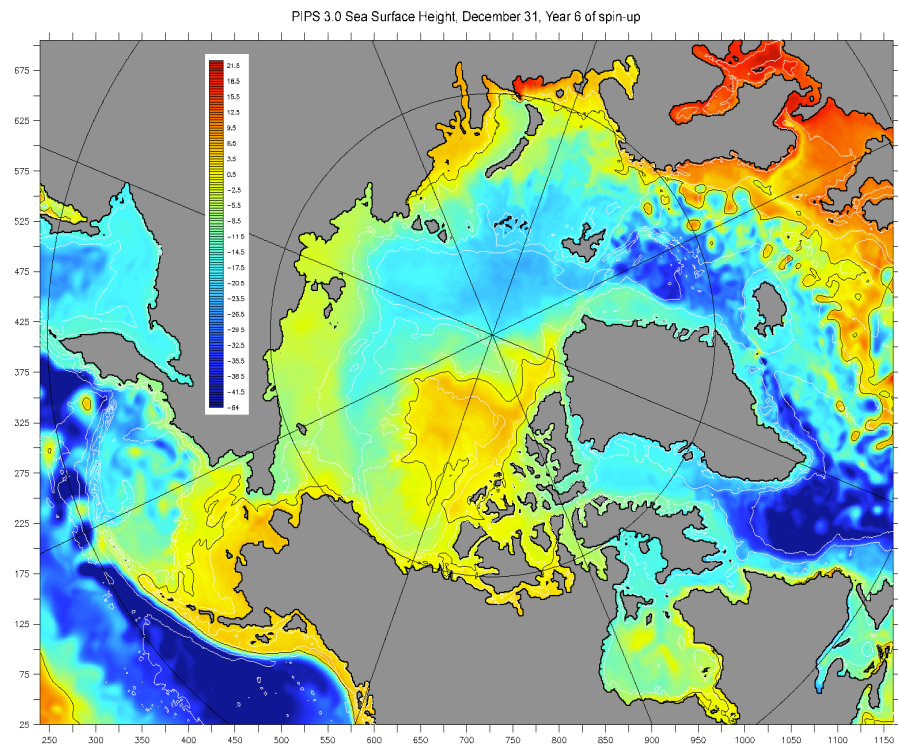

OSU98 Mean Sea Surface minus GRACE GGM01S Geoid

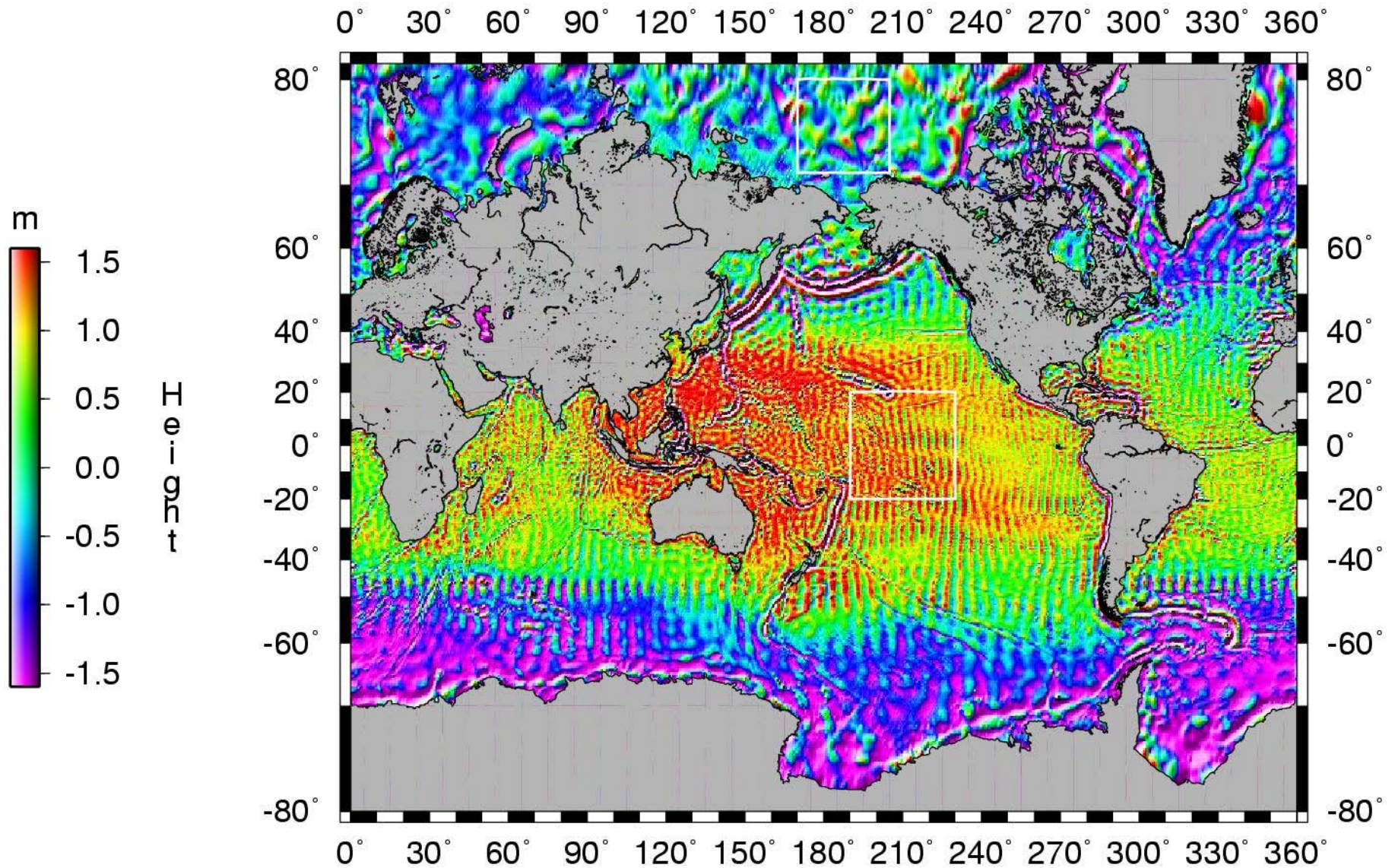

PSDs: MSS and MSS minus GRACE Geoid

Equatorial Area vs Arctic Area

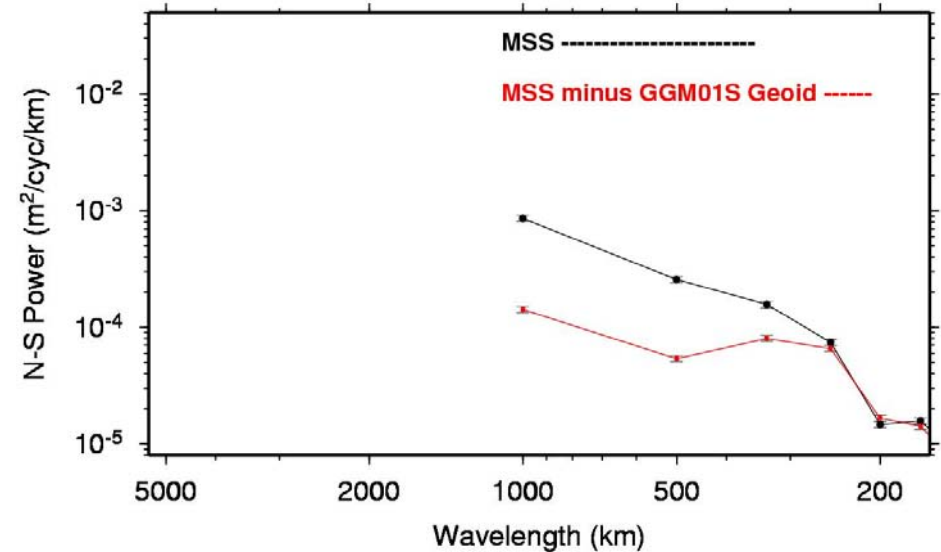
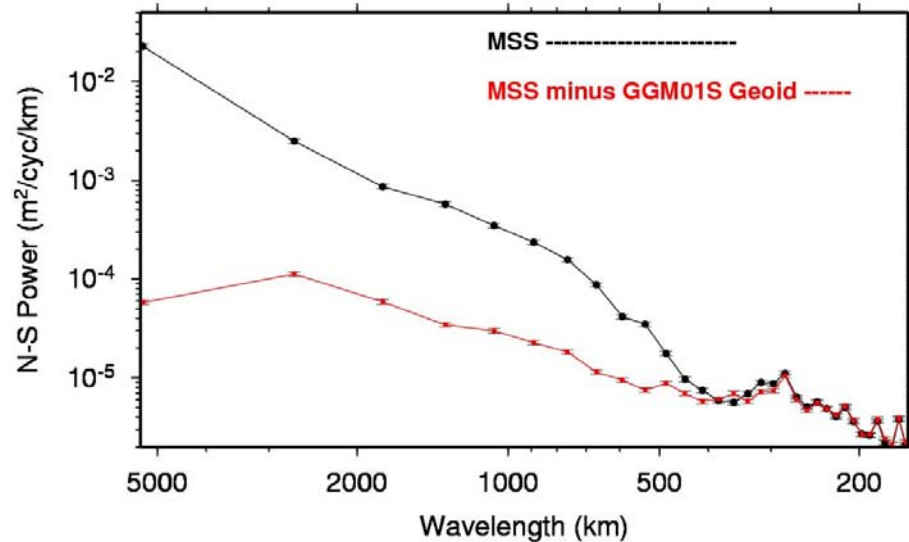
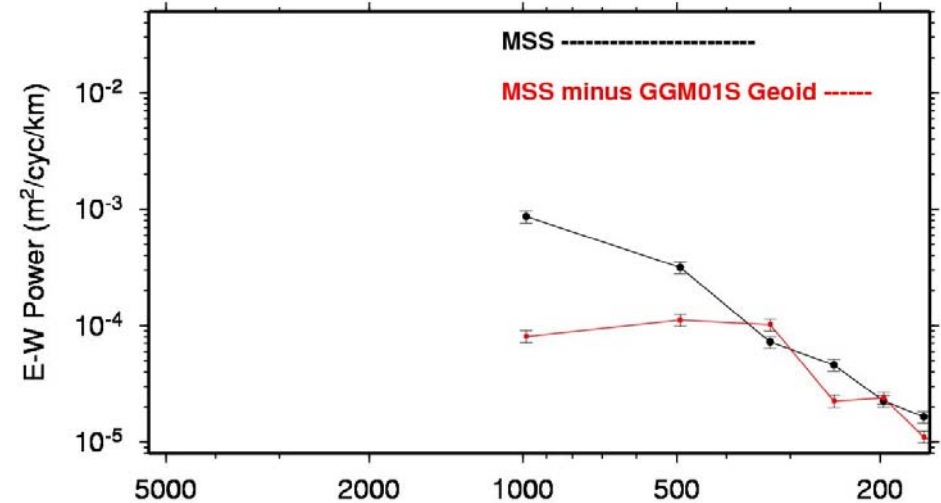
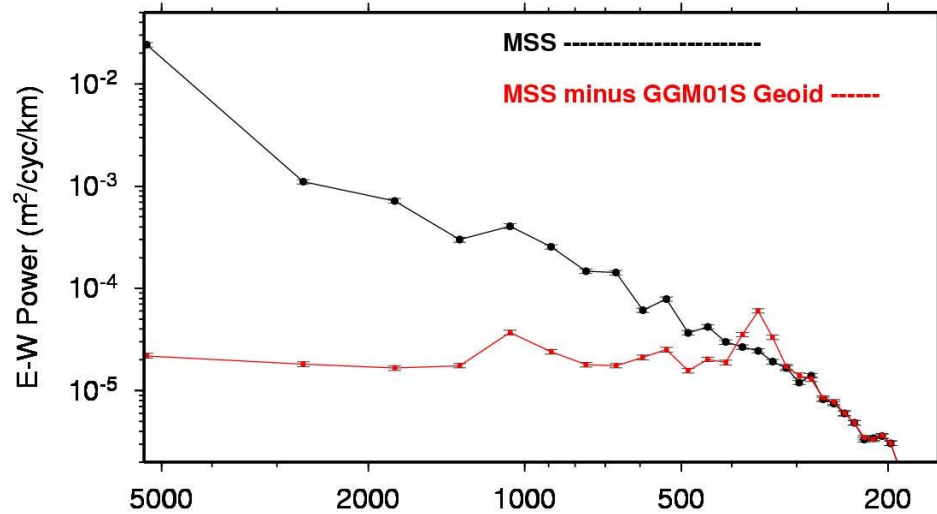

Airborne (NRL) and Surface Gravity in the Arctic

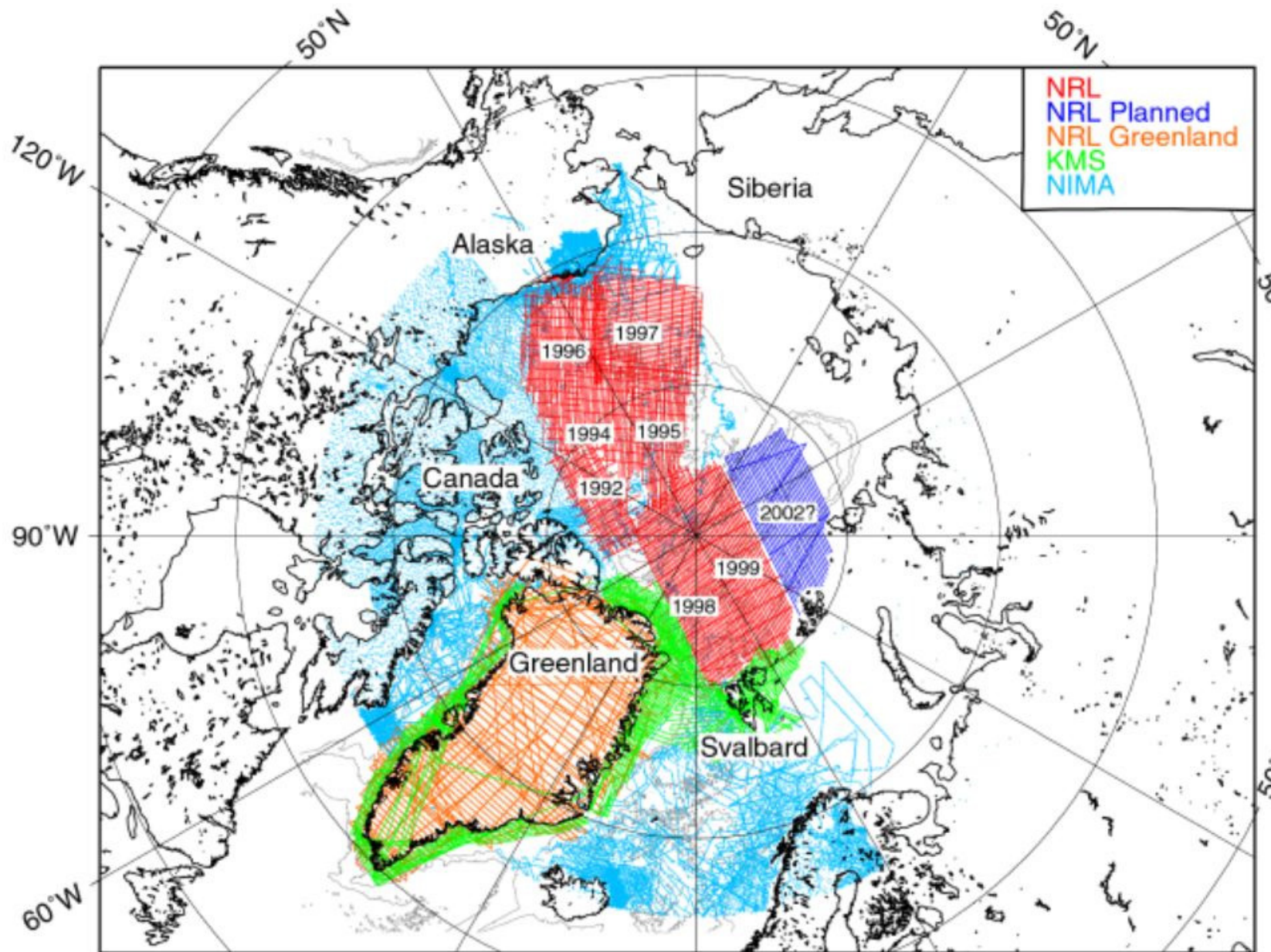

Summary

Comparisons of satellite gravity models with detailed Arctic models (ArcGP and ERS) show:

GRACE models confidently resolve and improve our understanding of Arctic gravity to wavelengths as short as 500km. Precision of GGM01S and EIGEN-GRACE models are nearly identical notwithstanding larger amount of data in GGM01S.

GRACE satellite-only geoids (GGM01S and EIGEN-GRACE) are precise (all wavelengths) to 40 cm or better over large areas of the Arctic. These GRACE geoids appear more accurate in the Arctic and lack the E-W noise/stripping (350 km wavelength) present at lower latitudes

“New” GRACE-ArcGP hybrid geoid presented. Such geoids may have accuracy needed to detect (with altimetry) poorly known dynamic topography of the Arctic Ocean

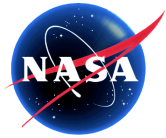

Surface Mass Variations and Earth Rheology - A Global Inverse Approach

Xiaoping “Frank” Wu
Jet Propulsion Laboratory

- Long Term Objective:

Use secular data combination for present-day surface mass trend, ice history, and mantle rheology

- Near-term Objective:

Use seasonal and interannual GPS load-induced deformation to validate time-variable gravity and surface mass variation

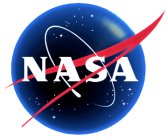

Global Function

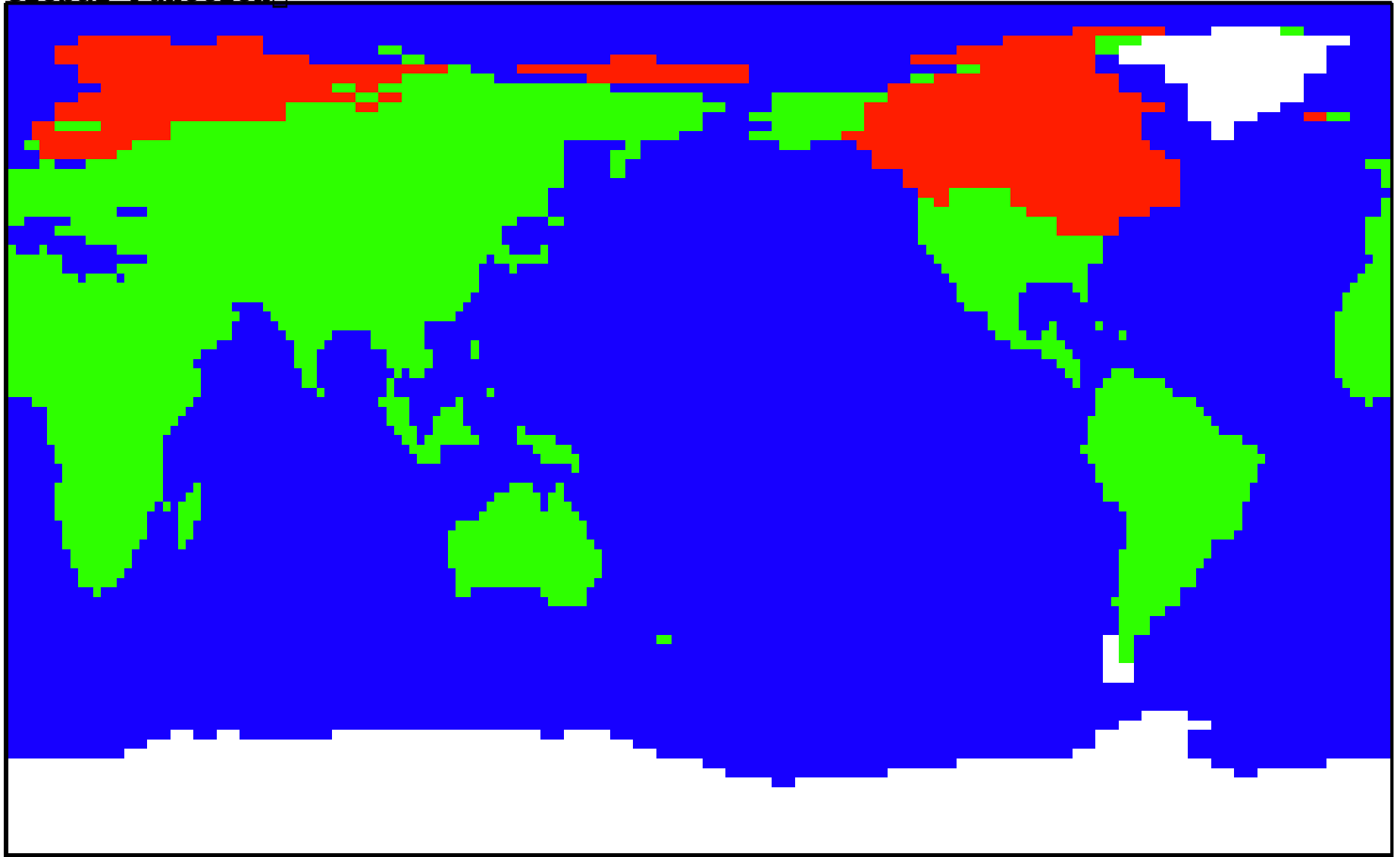

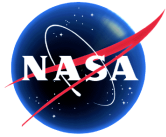

Long Term Objectives



$$\begin{aligned}\dot{N}_{lm} &= \dot{N}_{lm}(\dot{M}_{lm}^{\text{CUR}}) + \dot{N}_{lm}^{\text{PGR}}(M_{\text{past}}, \boldsymbol{\tau}, \boldsymbol{\nu}), \\ \dot{U}_{lm} &= \dot{U}_{lm}(\dot{M}_{lm}^{\text{CUR}}) + \dot{U}_{lm}^{\text{PGR}}(M_{\text{past}}, \boldsymbol{\tau}, \boldsymbol{\nu}) + \dot{C}_{lm} \\ RSL_i &= R_i(M_{\text{past}}, \boldsymbol{\tau}, \boldsymbol{\nu})\end{aligned}$$

- Two major ambiguities
- Use secular gravity, altimetry, GPS and relative sea-level data combination
- Global inverse algorithm for simultaneous solution

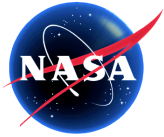

Near-Term Objective



- Seasonal and interannual surface mass variation will
 - Load the solid Earth and cause surface deformation
 - Perturb gravity field

$$S = \frac{4\pi a^3}{M_E} \sum_{n=1}^{\infty} \sum_{m=0}^n \sum_{q=c,s} \frac{M_{nmq}}{2n+1} [h'_n Y_{nmq} \hat{e}_r + l'_n \partial_{\vartheta} Y_{nmq} \hat{e}_{\vartheta} + l'_n \frac{1}{\sin\theta} \partial_{\varphi} Y_{nmq} \hat{e}_{\varphi}]$$

$$N = \frac{4\pi a^3}{M_E} \sum_{n=1}^{\infty} \sum_{m=0}^n \sum_{q=c,s} \frac{M_{nmq}}{2n+1} (1 + k'_n) Y_{nmq}$$

- Global inversion of GPS deformation for surface mass
- Truncation to degree and order 6
- Assess aliasing error using geophysical model
- Compare with time-variable gravity

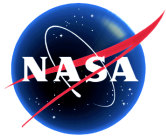

GPS Inverted

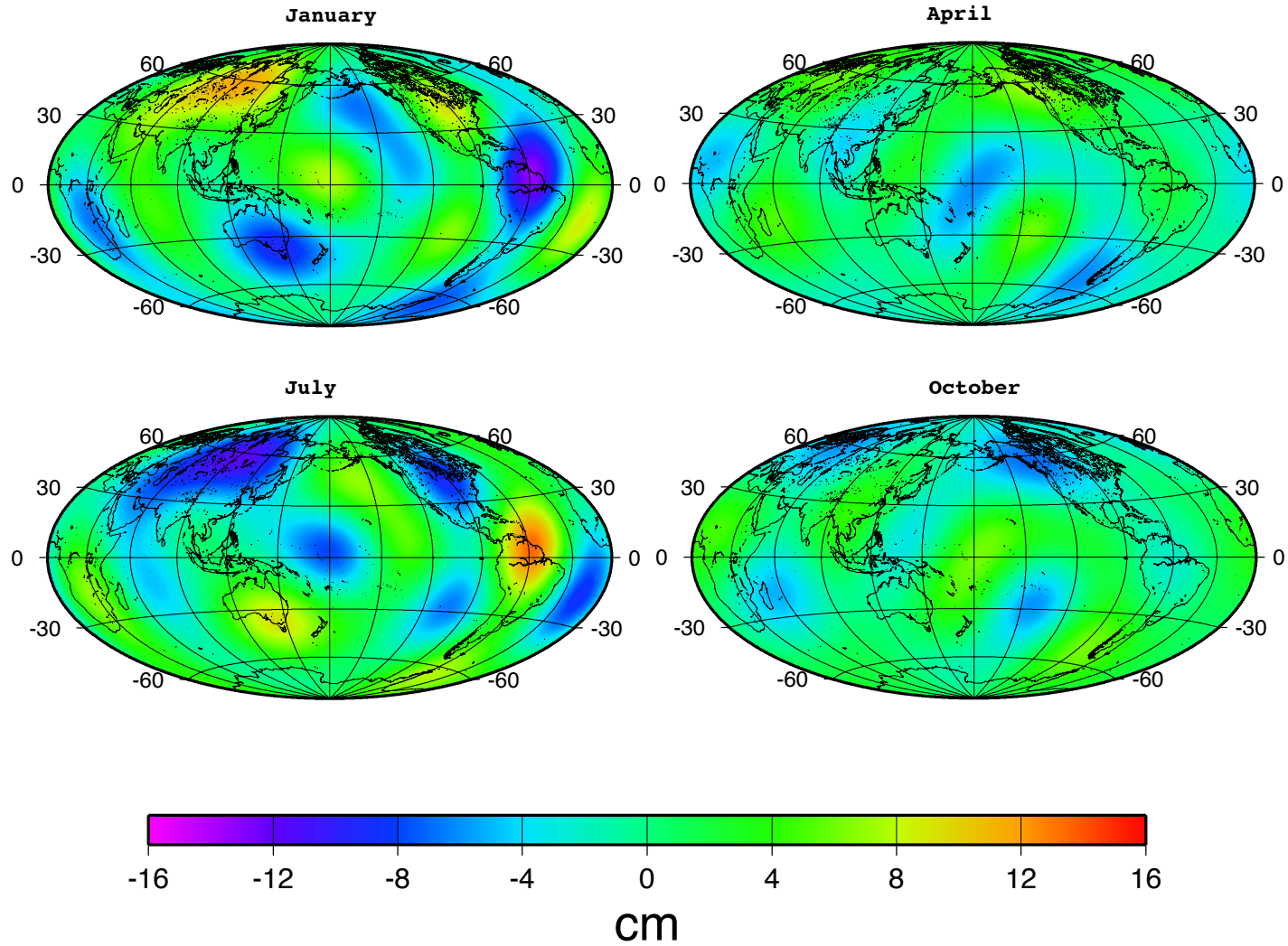

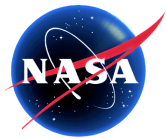

Geophysical model Prediction

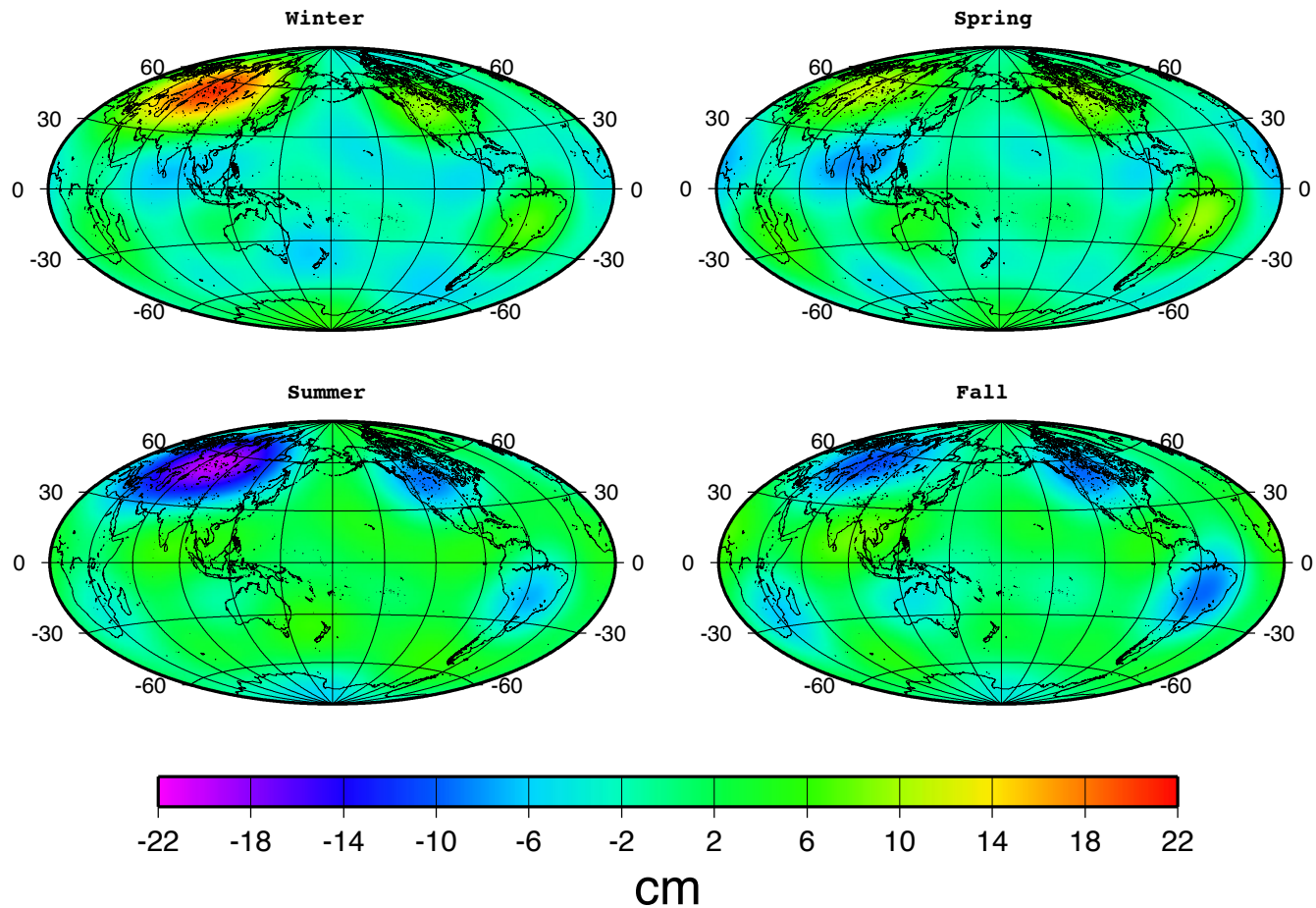

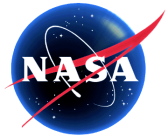

Inverse Uncertainty in Equivalent Water Thickness

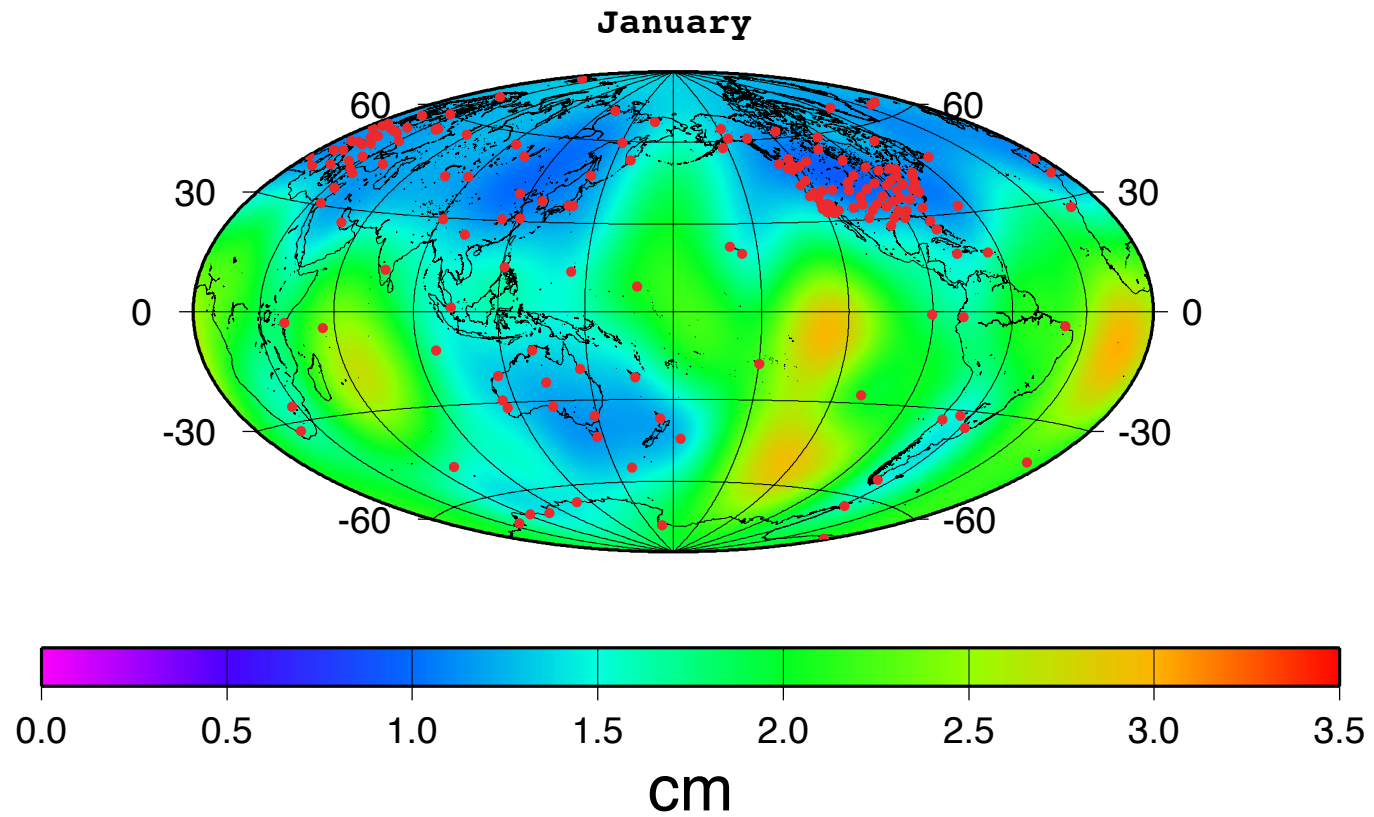

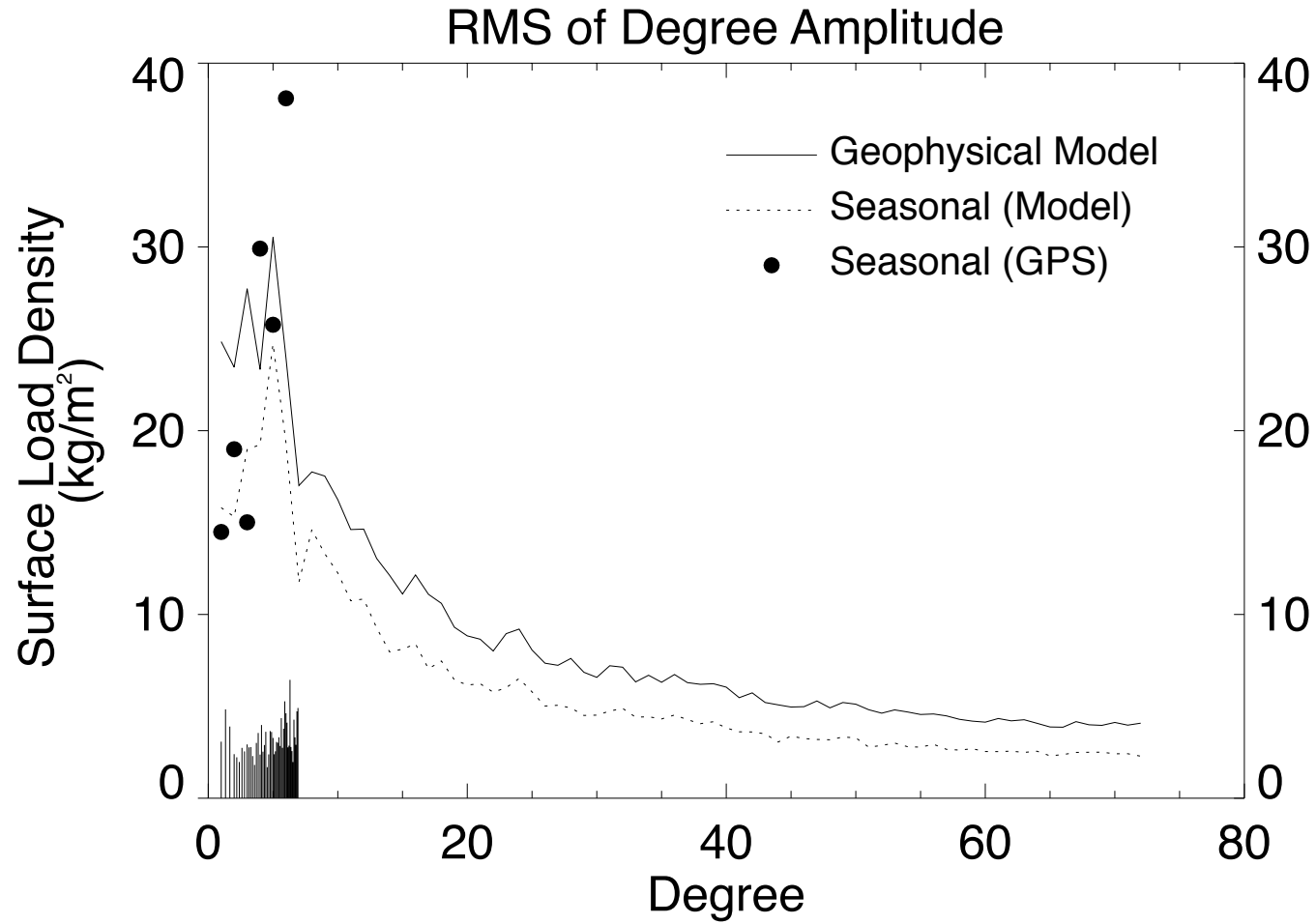
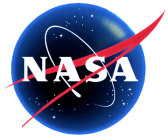

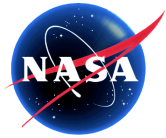

Annual GPS and SLR



Parameter	Unit	A^a		φ^a			
		SLR	GPS	SLR	GPS		
ΔX_g	mm	2.1 \pm 0.5		48	119 \pm 131		
ΔY_g	mm	2.0 \pm 0.5		327	16 \pm 20		
ΔZ_g	mm	3.5 \pm 1.5		43	27 \pm 13		
ΔJ_2	10^{-10}	2.8	3.2	2.6 \pm 0.6	223	246	287 \pm 14
ΔJ_3	10^{-10}	5.7	2.0	2.2 \pm 0.8	19	6	294 \pm 19
ΔJ_4	10^{-10}	3.2	1.3	0.8 \pm 0.6	22	26	65 \pm 38
ΔJ_5	10^{-10}	3.7		2.0 \pm 0.8	211		98 \pm 20
ΔJ_6	10^{-10}	0.9		2.0 \pm 1.0	23		348 \pm 32

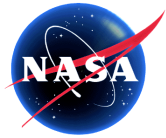

Summary and Future



- GPS agrees with SLR on geocenter and zonal harmonics fairly well
- The importance of degree-1 surface mass variation
- Significant $n > 1$ and non-zonal surface mass variations are also found
- To validate and complement GRACE time-variable gravity

Wu *et al.*, *Geophys. Res. Lett.*, **29** (24), 2210-2213, 2002

Wu *et al.*, *Geophys. Res. Lett.*, **30** (14), 1742-1745, 2003



Impact of CHAMP and GRACE gravity modeling on oceanography

**Schroeter J., Wenzel M., Staneva J., Kivman G.,
Danilov S.**

**Alfred-Wegener-Institut für Polar-und
Meeresforschung**



AWI Ocean Circulation Model BRI2



Mean model topography from 9 years of TOPEX/Poseidon SSH anomalies, SST and hydrographic data; assimilation by 4DVAR technique.

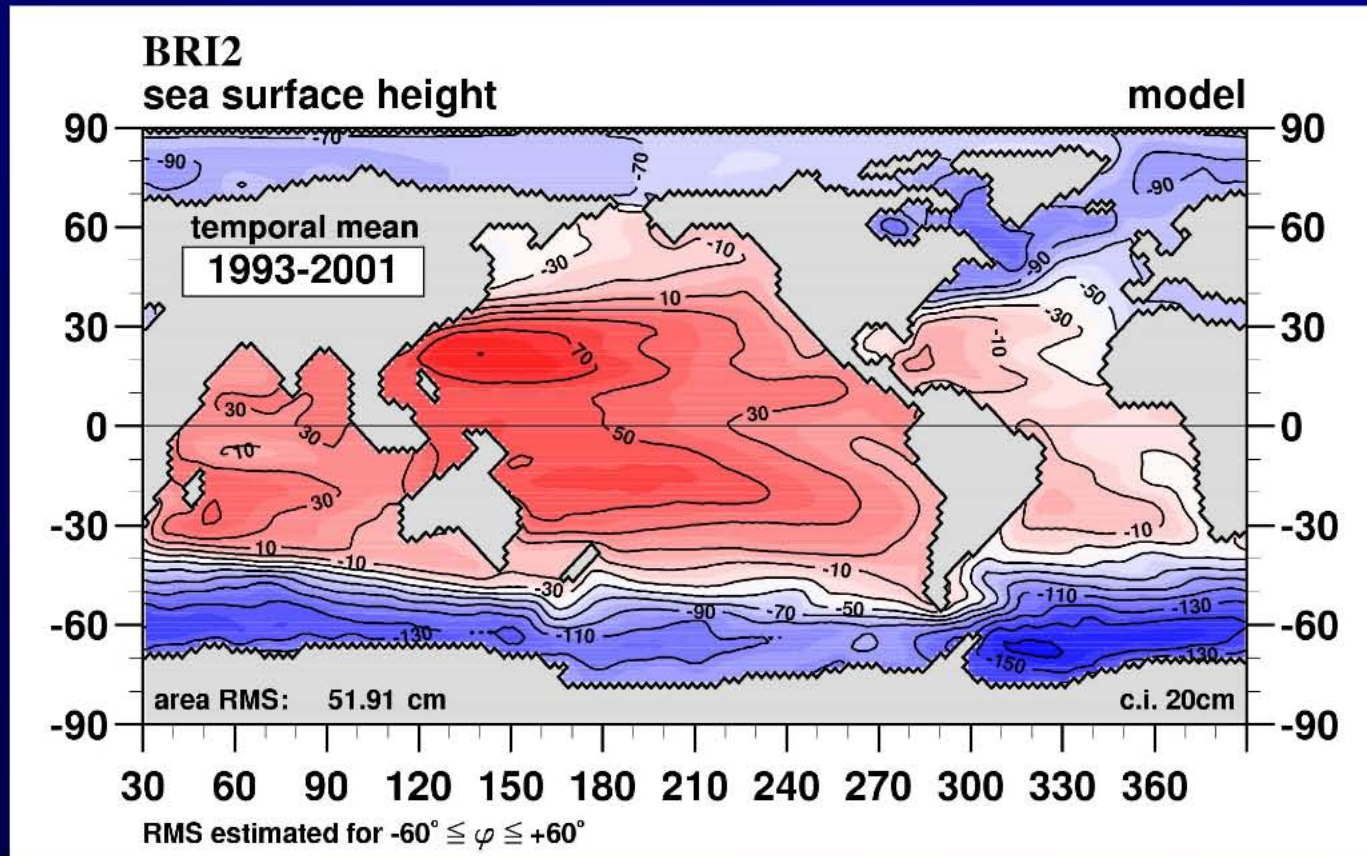

Closure discrepancy: $BRI2 - (CLS98.2 - EGM96)$

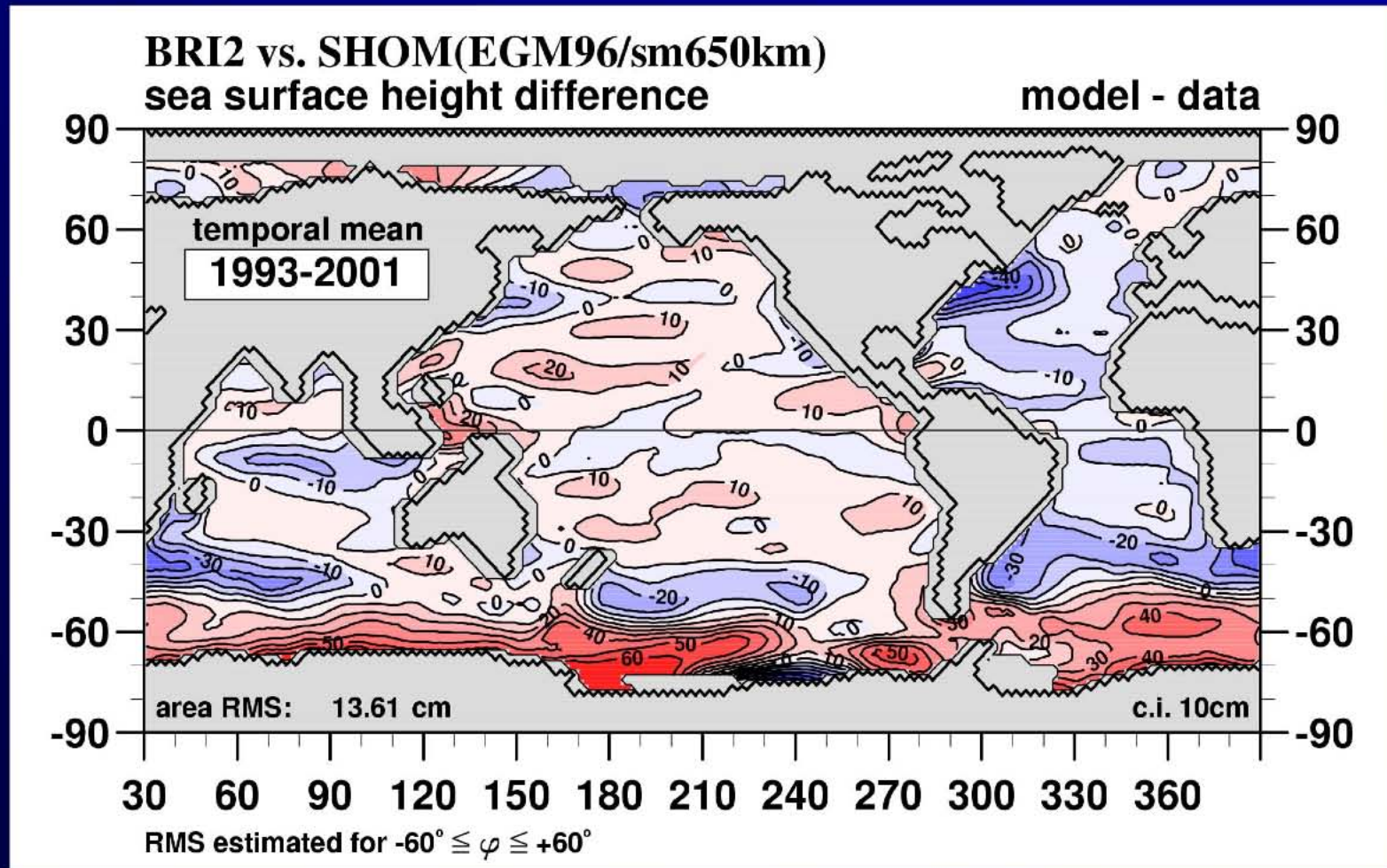

Closure discrepancy: $BRI2 - (CLS98.2 - EIGEN-CHAMP^*)$

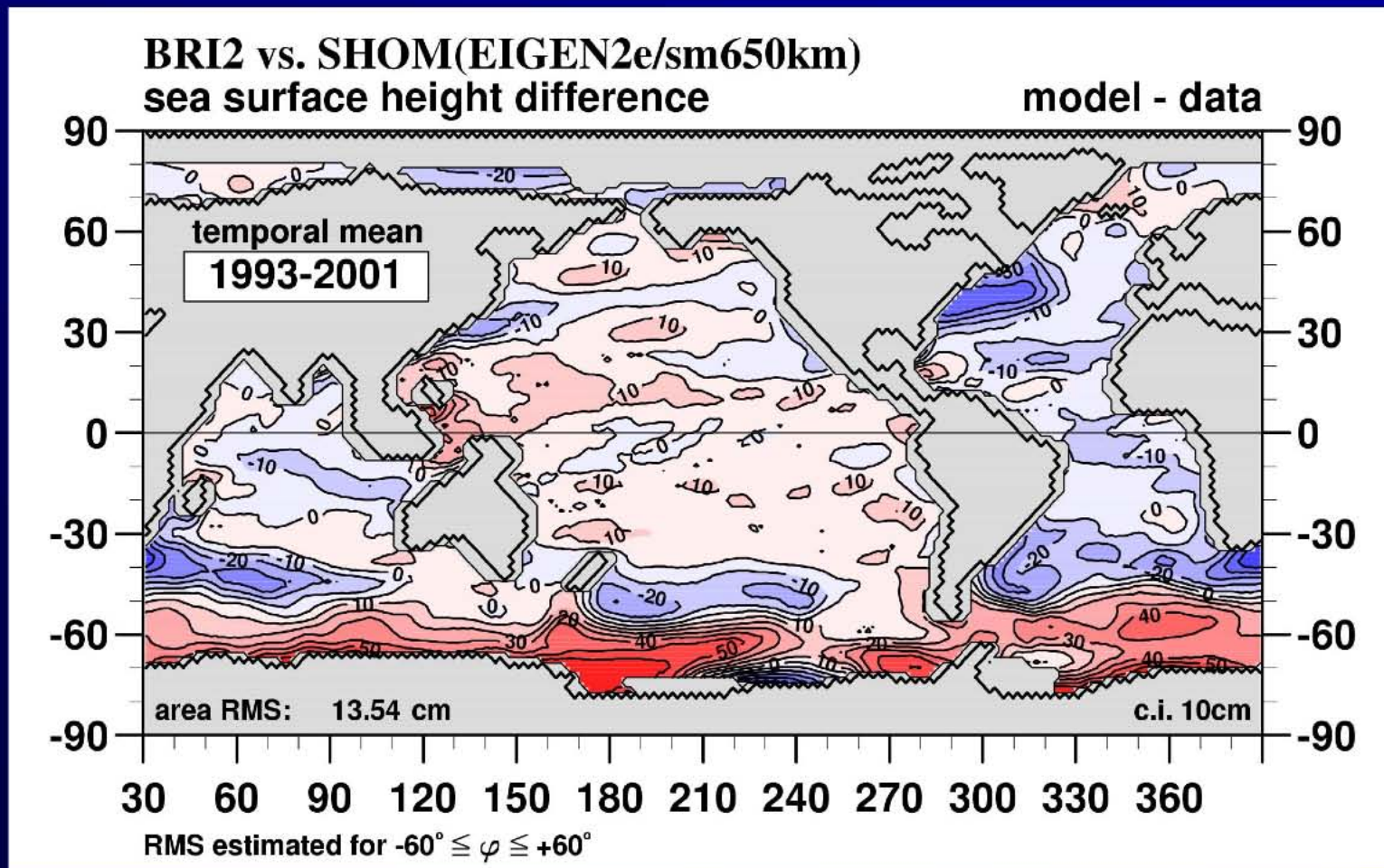

* Not the latest CHAMP-only solution

Closure discrepancy: $BRI2 - (CLS98.2 - EIGEN-GRACE01Sup)$

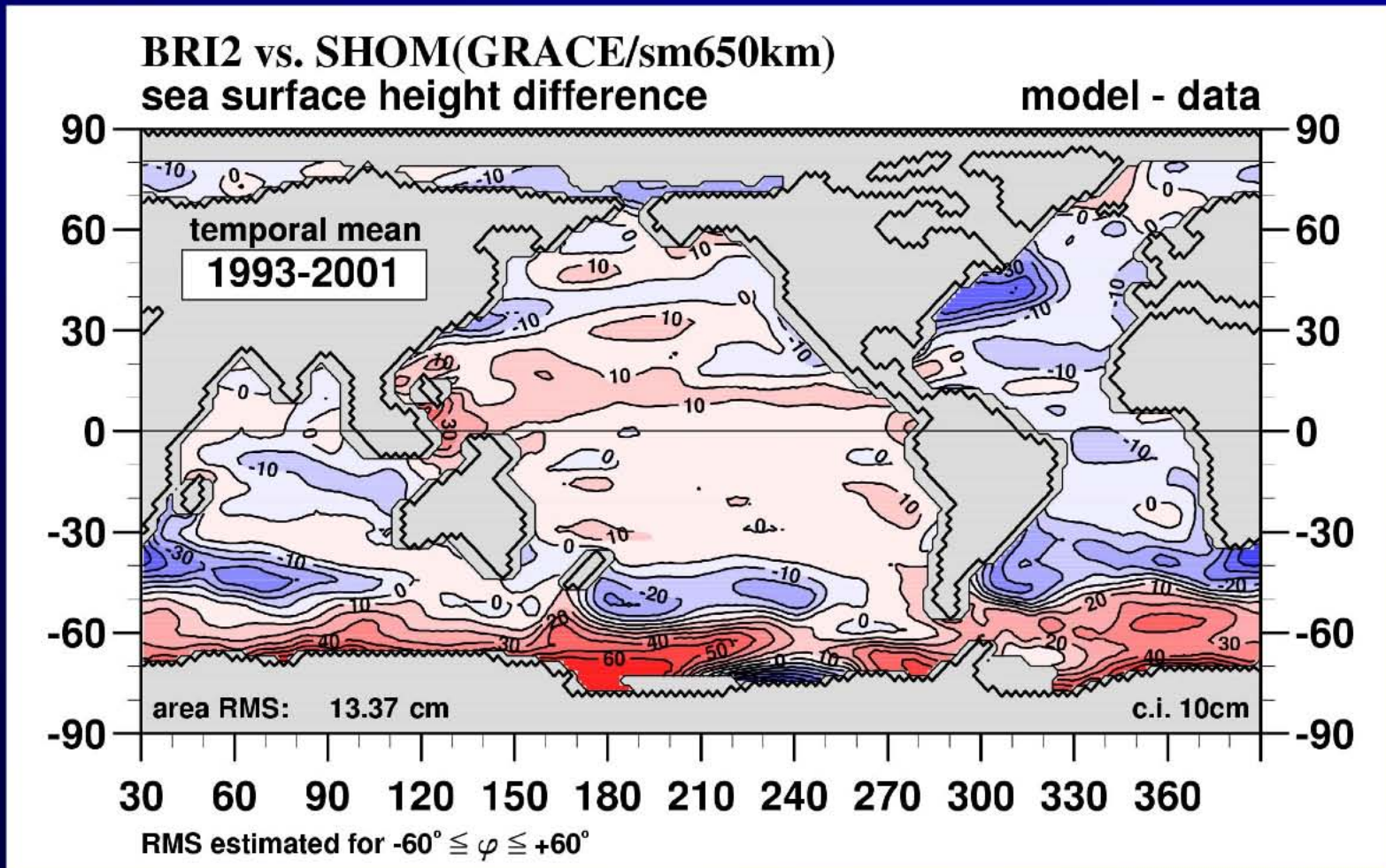



Regional AWI Model SSH



Optimal fit to Levitus data

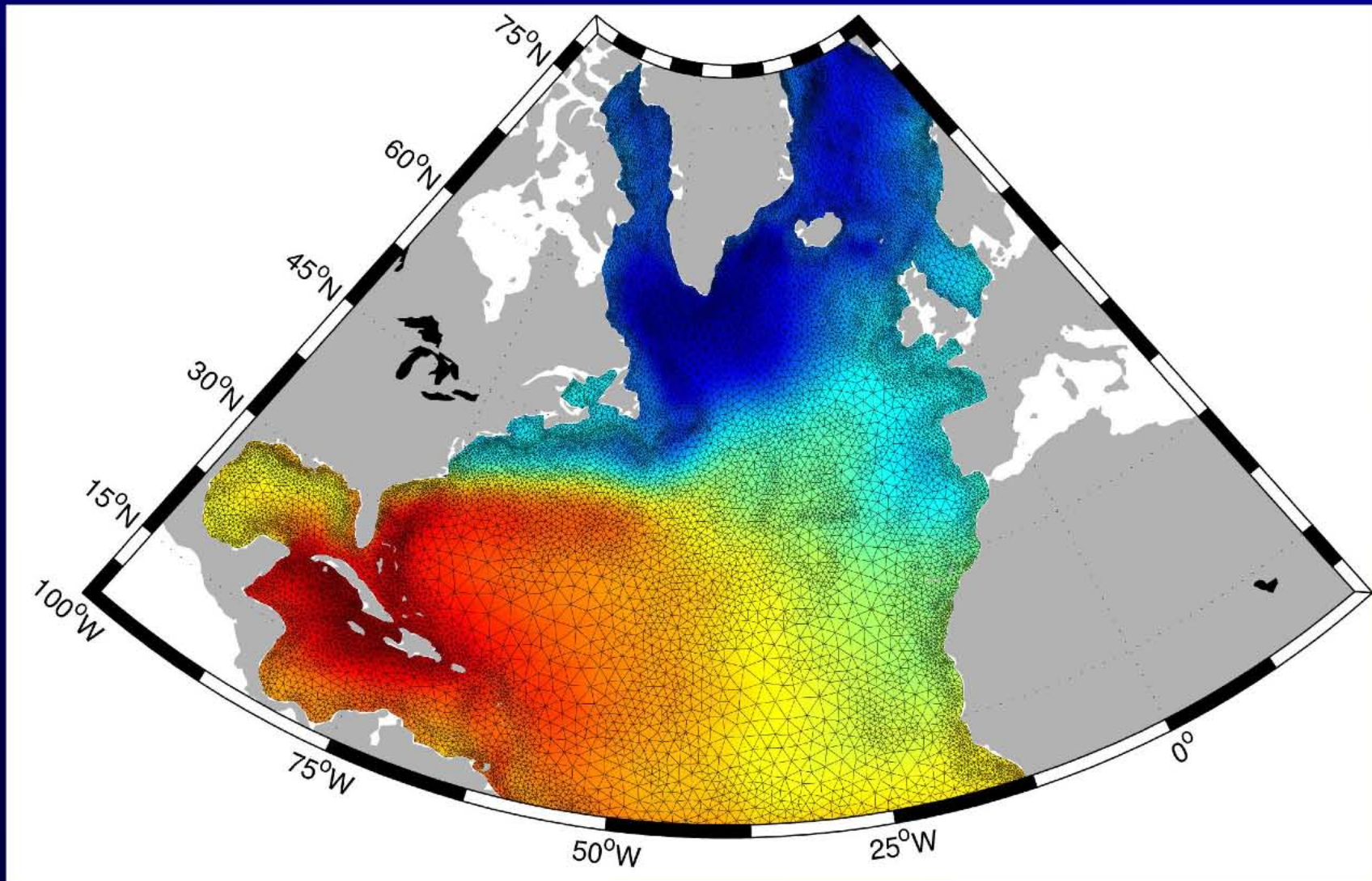



Dynamic SSH from CLS98.2 altimetry and EIGEN-CHAMP* geoid



350 km Gauss Filter

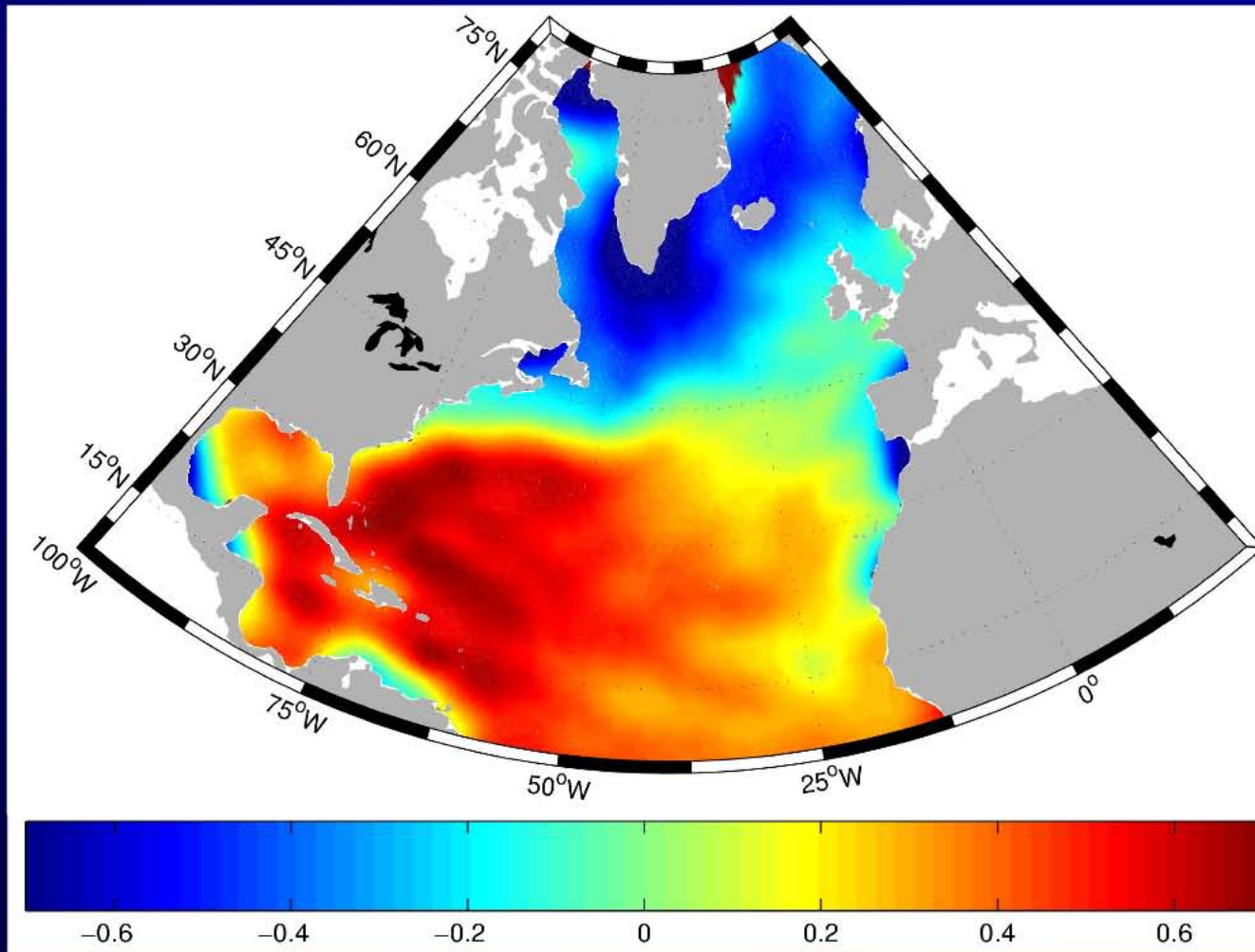

* Not the latest CHAMP-only solution



Dynamic SSH from CLS98.2 altimetry and EIGEN-GRACE01Sup geoid



350 km Gauss Filter

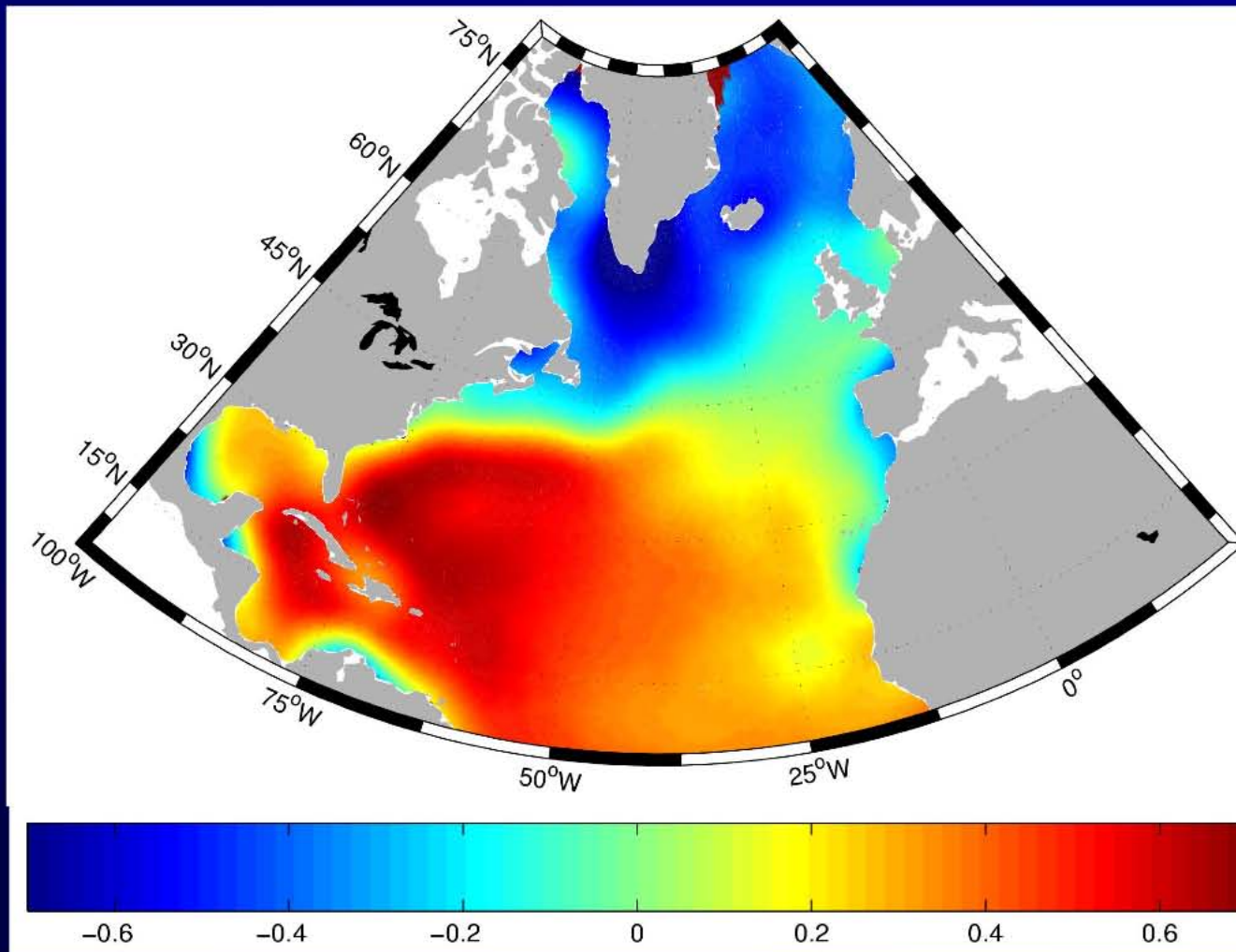

Closure Discrepancy

Closure discrepancy: AWI Model SSH– (CLS98.2 – EGM96)

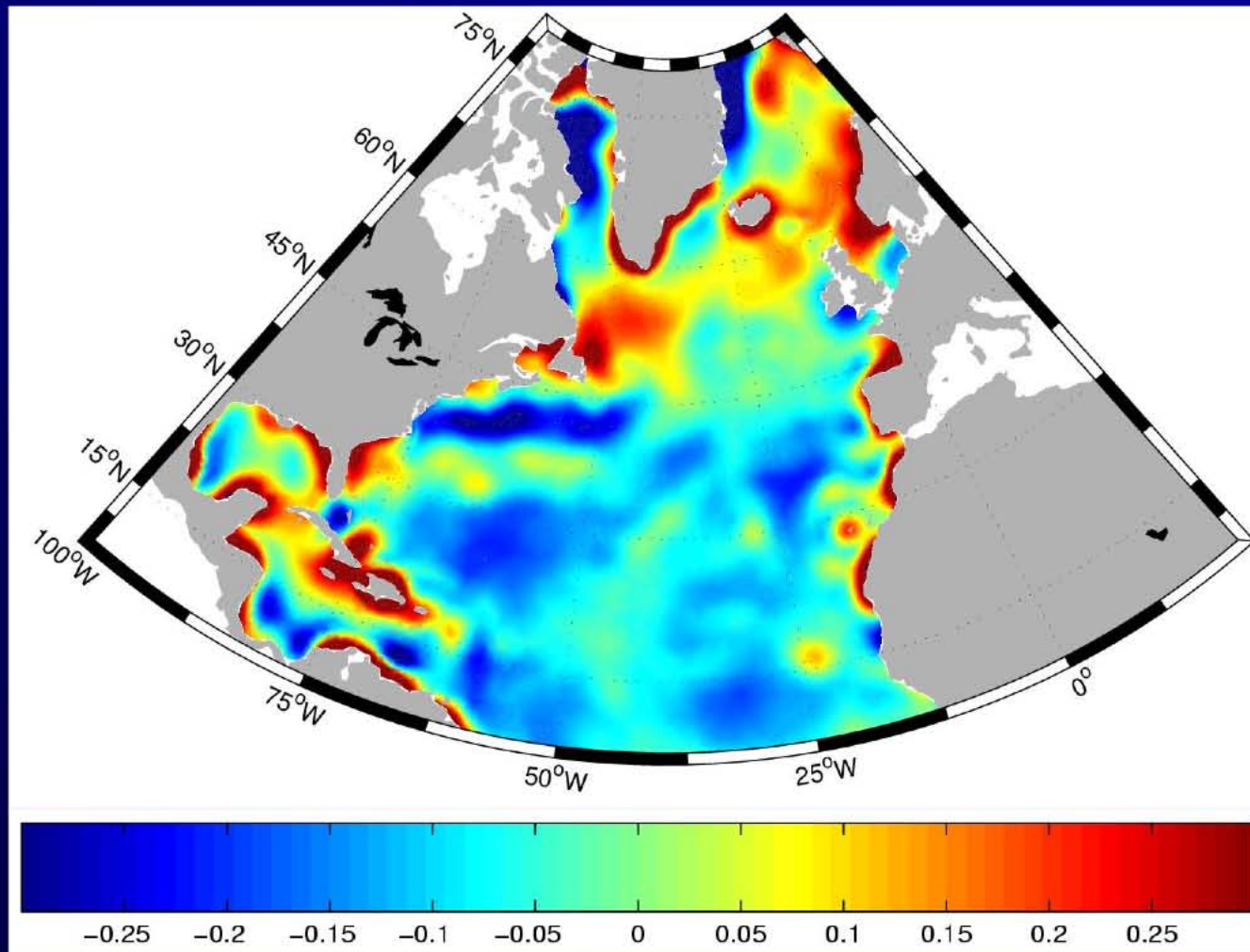

Closure Discrepancy

Closure discrepancy: AWI Model SSH– (CLS98.2 – EIGEN-CHAMP*)

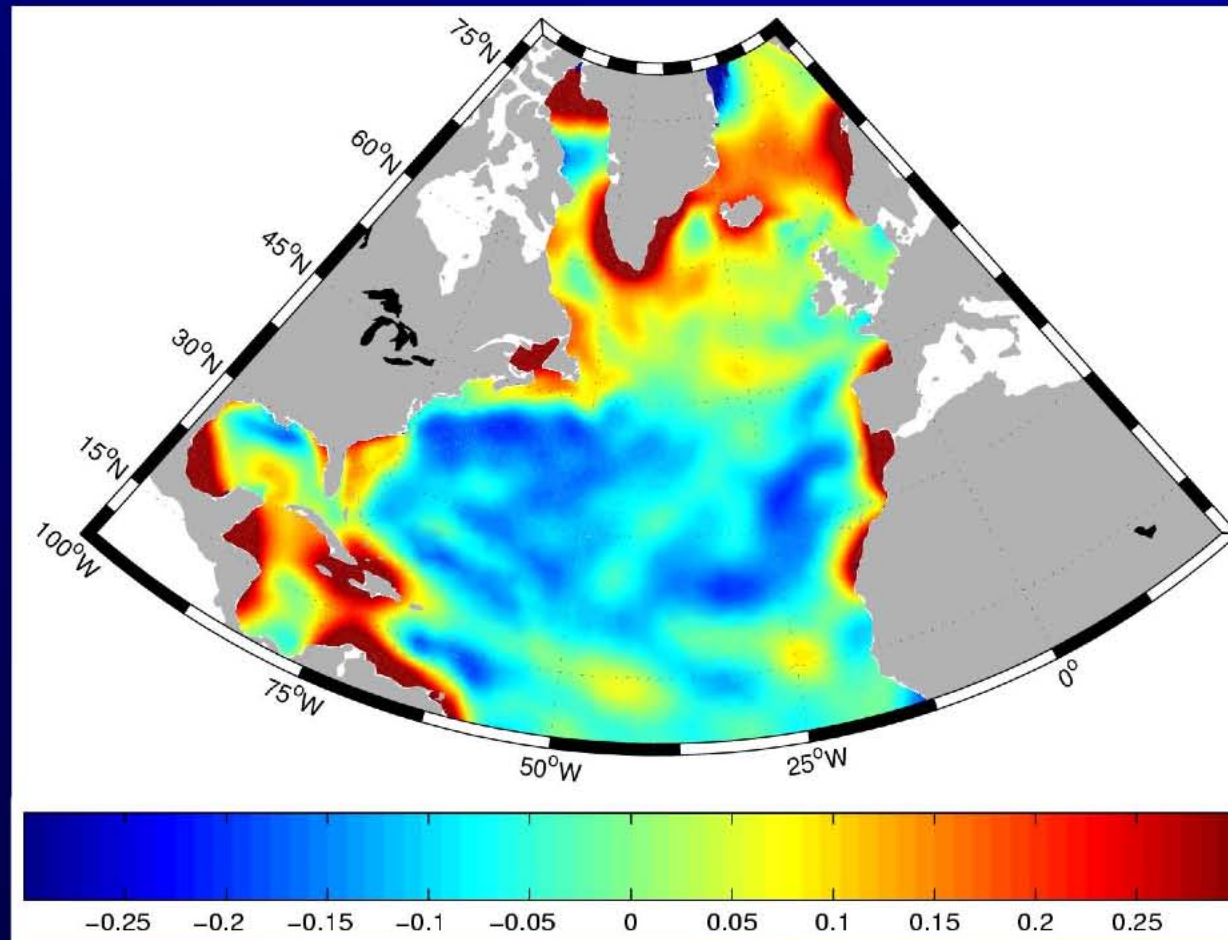

* Not the latest CHAMP-only solution



Closure Discrepancy



Closure discrepancy: AWI Model SSH – (CLS98.2 – EIGEN-GRACE01Sup)

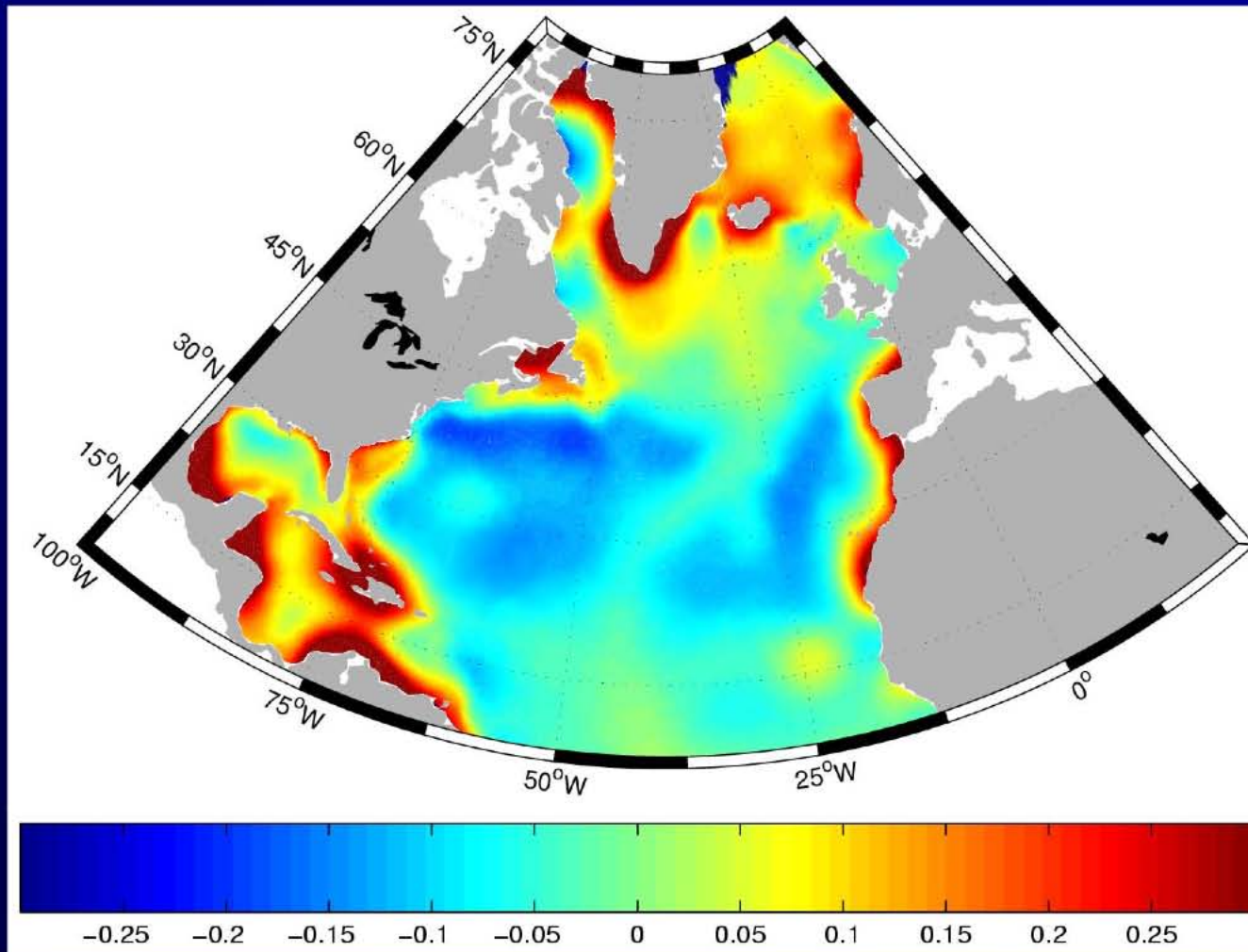

Closure discrepancy: AWI Model SSH (EIGEN – CHAMP * assim.) --
 (CLS98.2 – EIGEN-CHAMP*)

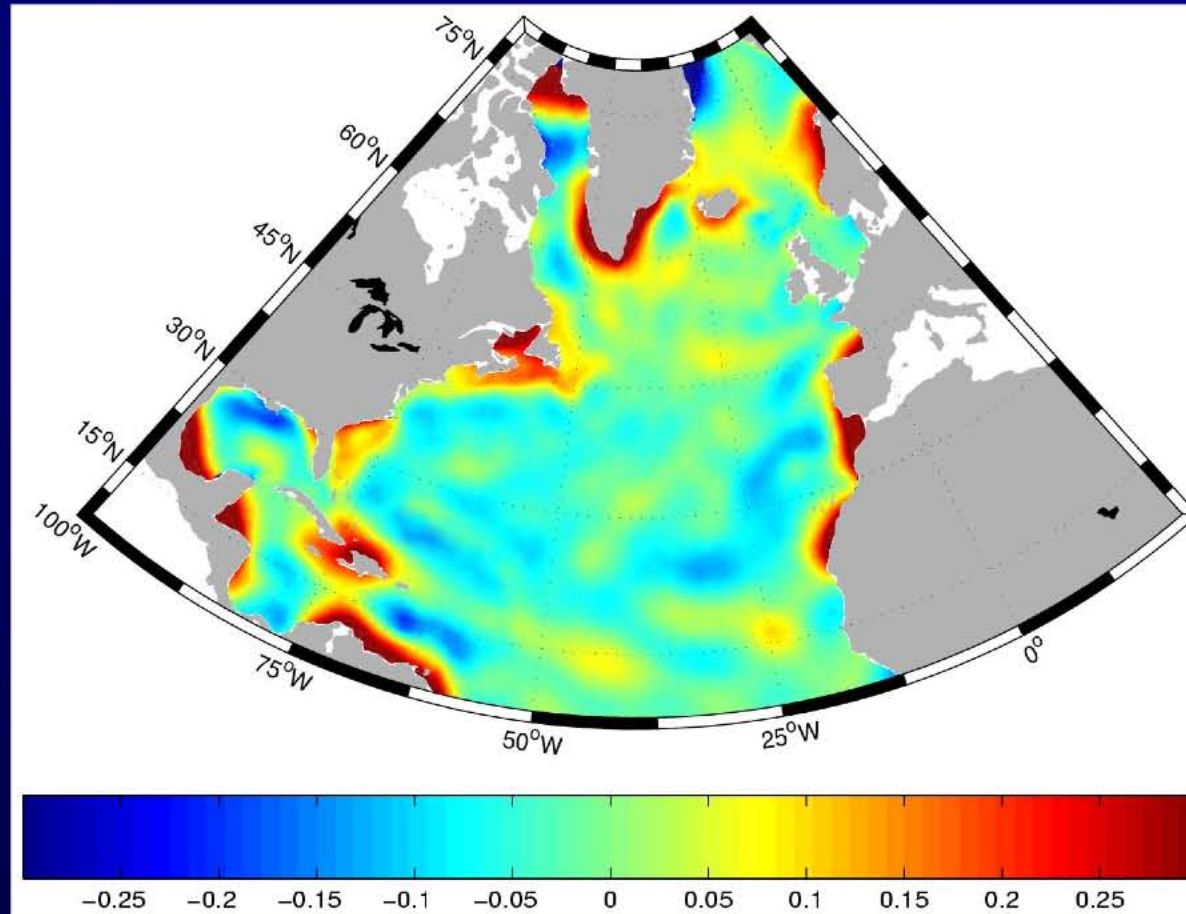

* Not the latest CHAMP-only solution



Assimilation of Gravity Models



Closure discrepancy: AWI Model SSH(EIGEN-GRACE 01Sup assim.)--
(CLS98.2 – EIGEN- GRACE 01Sup)

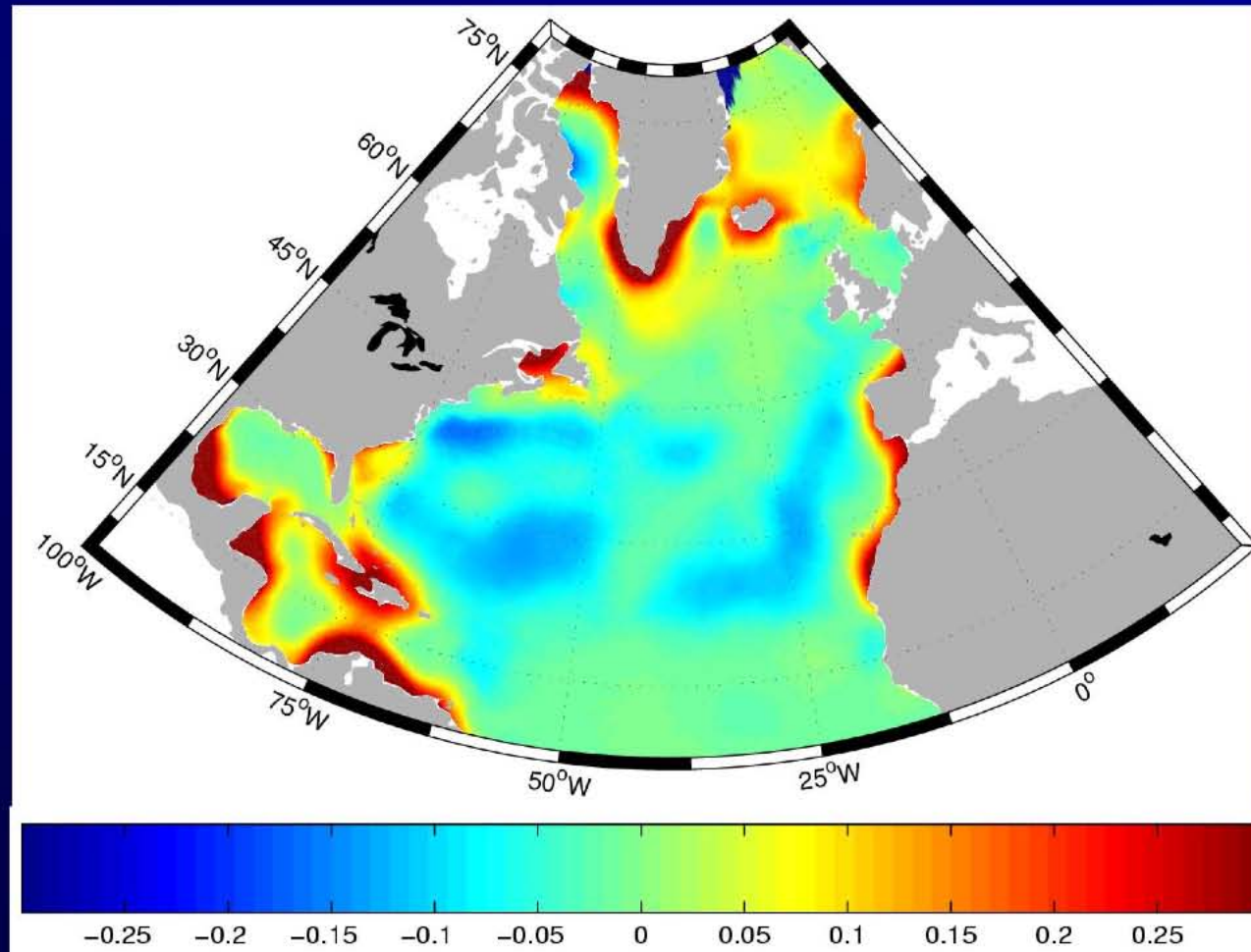

Change in Meridional Heat Transport after assimilation, in PentaWatts

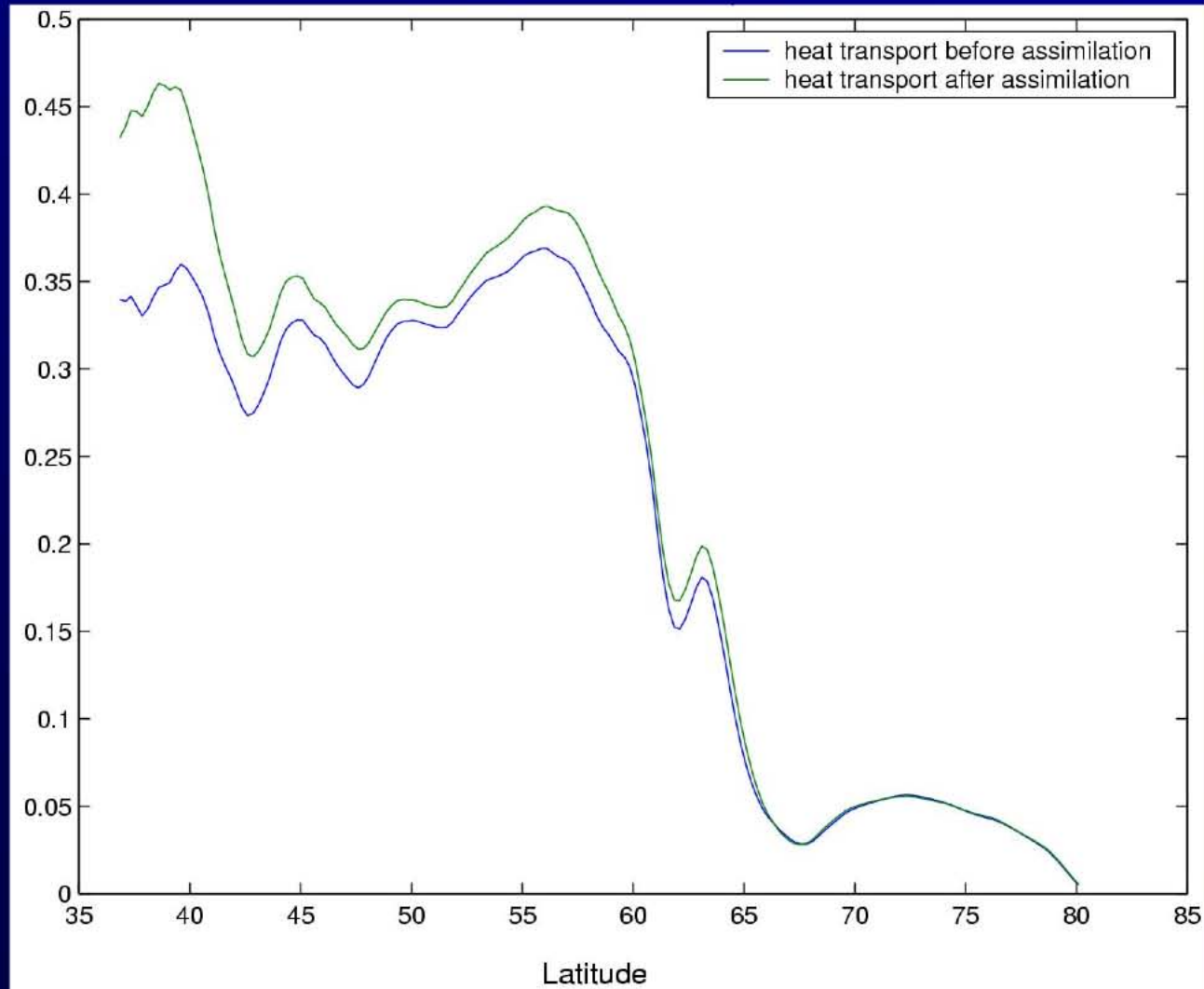

Application of GRACE Data to Improving Ocean Heat Storage Estimates from Satellite Altimetry

Don P. Chambers

**Center for Space Research
The University of Texas at Austin**

**GRACE Science Team Meeting
Austin, TX
9 October, 2003**

Goals of Investigation

- Verify GRACE time-varying geoid products (converted to equivalent sea level) by comparing to sea level residuals

$$\Delta = \Delta\eta_{altimetry} - \Delta\eta_{steric}$$

- » Steric sea level variations from integrated and filtered XBT casts
- » Altimetry from TOPEX and Jason-1
- A portion of the residual signal (a significant portion in some areas) should be caused by barotropic signals measurable by GRACE

$$\varepsilon = \Delta\eta_{altimetry} - \Delta\eta_{steric} - \Delta\eta_{GRACE}$$

- » Variance of ε should be $<$ Variance of Δ

Goals (cont)

- Once verified, reverse operation to remove barotropic signal with periods > 1 month from altimetry to improve estimates of steric sea level and heat storage variations

$$\Delta_{steric} \approx \Delta\eta_{altimetry} - \Delta\eta_{GRACE}$$

Current Work

- Have processed XBT data into steric sea level anomalies for period 1993-2003; continue on regular basis
- Processed TOPEX and Jason-1 sea level anomalies over same period; continue on regular basis

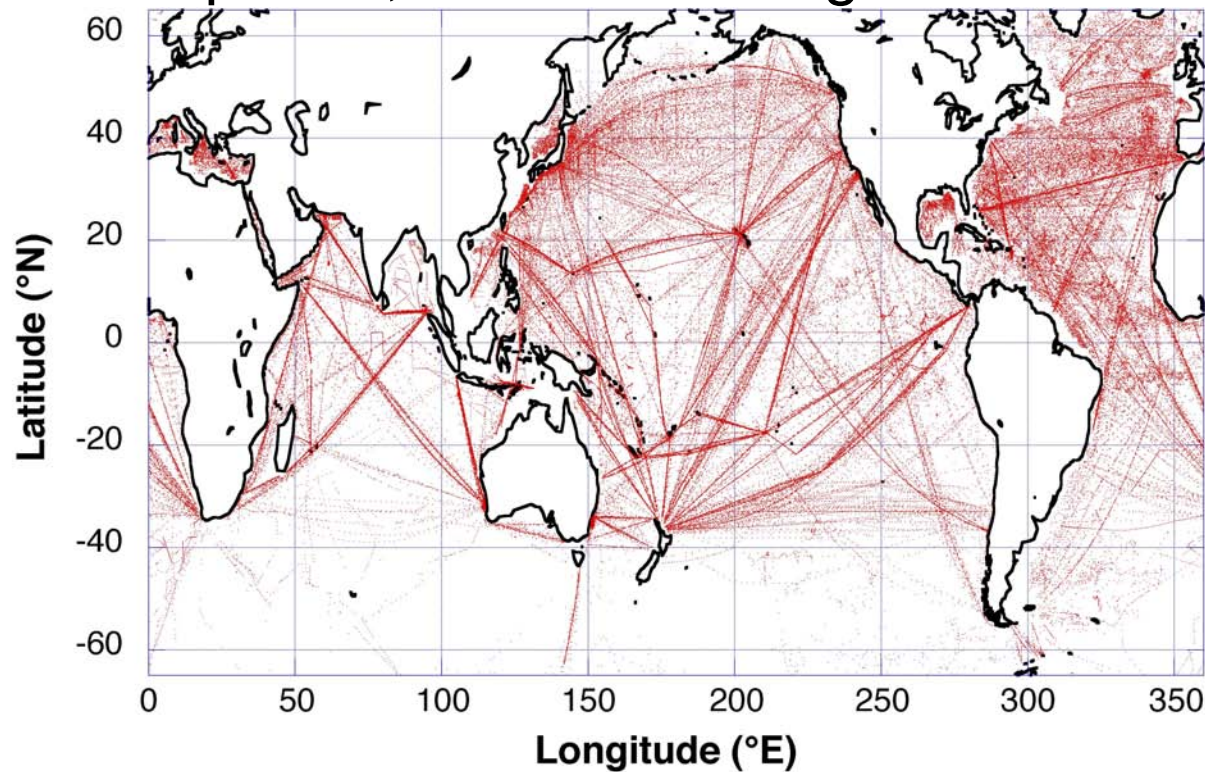

XBT casts used,
1993-2002

Current Work (cont)

- Have identified regions to conduct initial verification

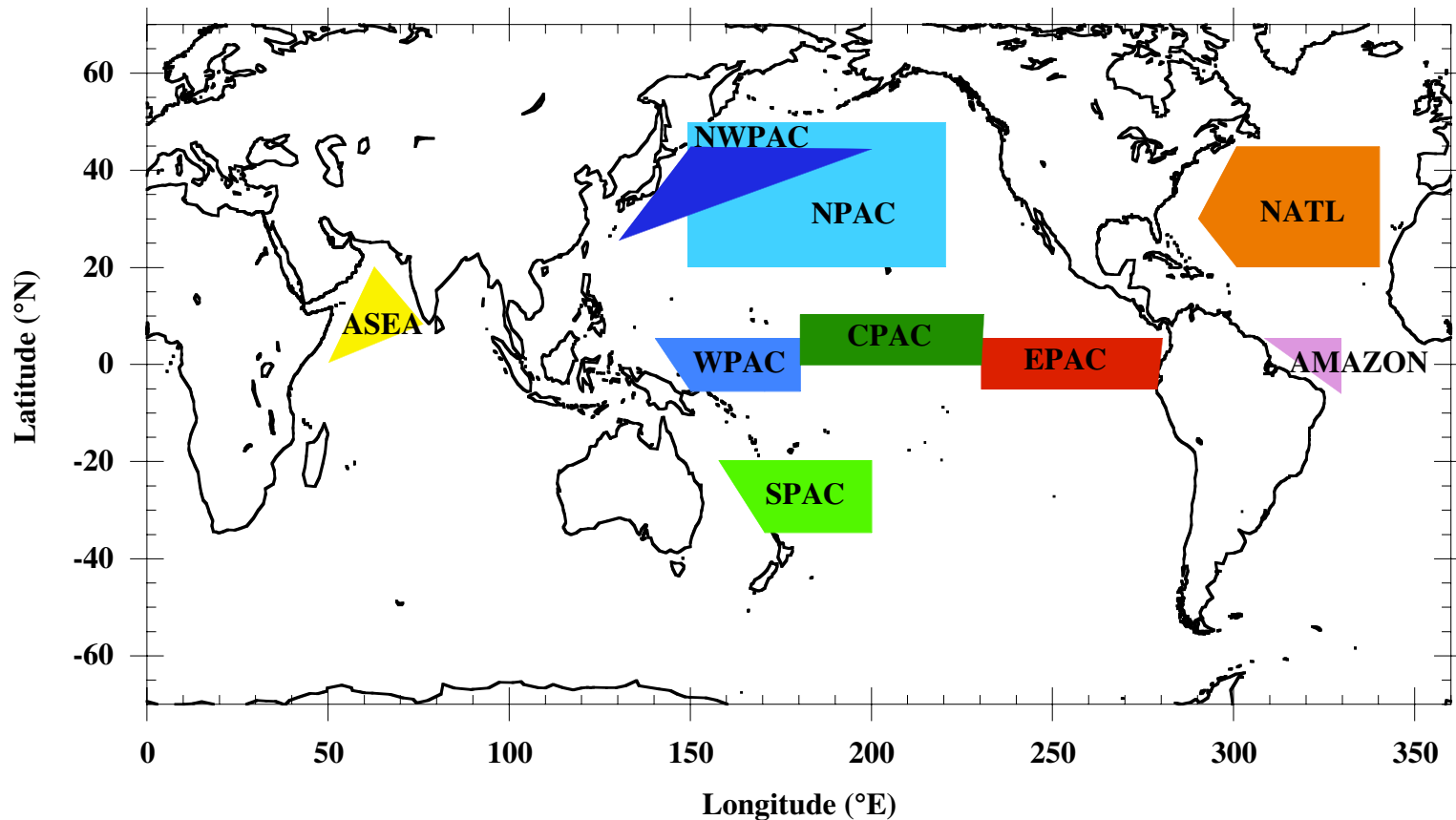

Planned Initial Work

- Since first GRACE maps will only cover one year (or most of a year) begin to look at monthly climatology of altimetry - XBT residuals
- Examine regions with significant annual variations in residuals
- Examine different smoothing of altimetry - XBT residuals
- Is current accuracy sufficient over the ocean?

Example Residuals

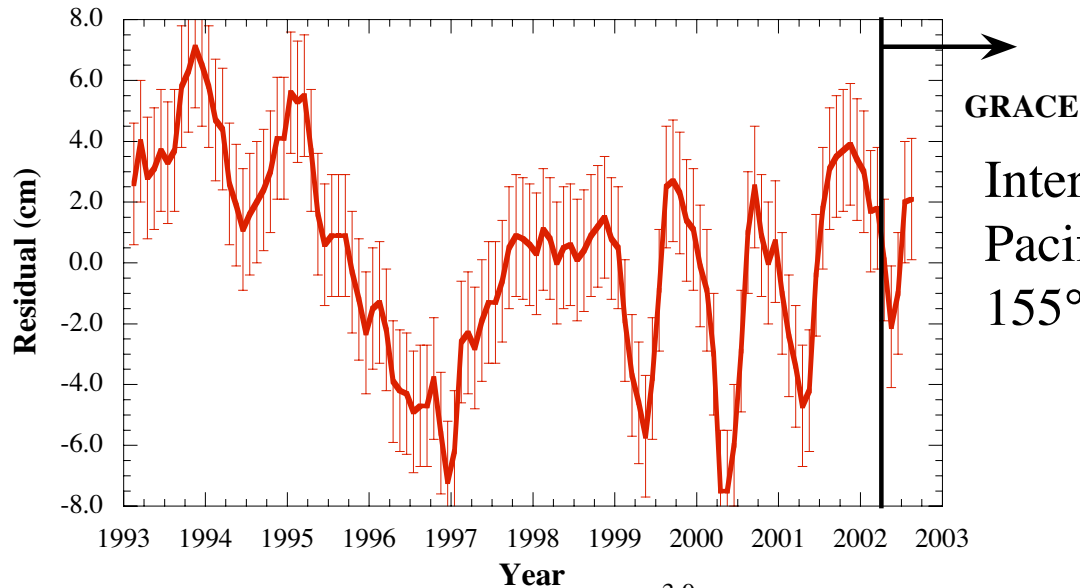

Interannual residuals in W. Pacific, centered at 3°S , 155°E

Monthly climatology in N Pacific, centered at 27°N , 170°E

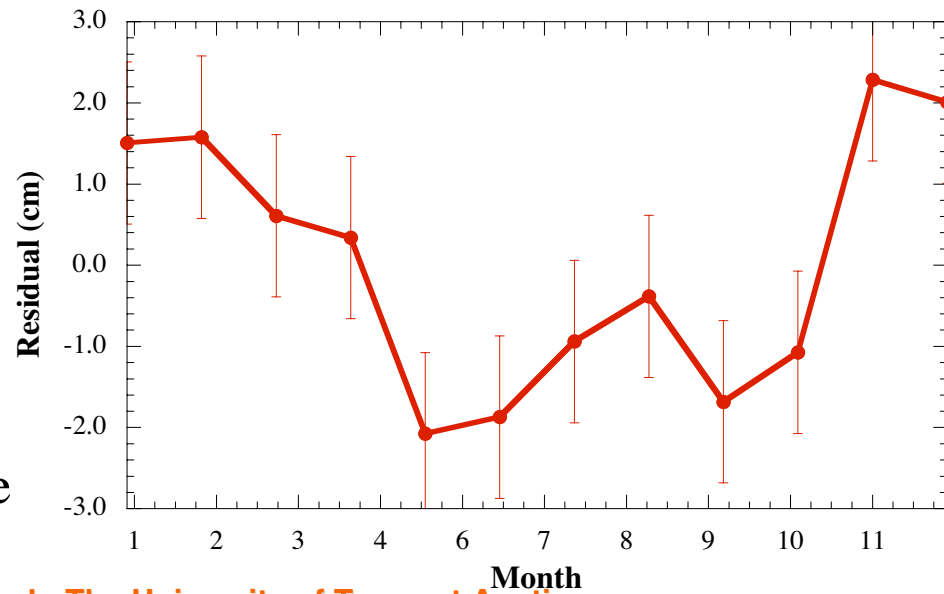

All residuals are altimetry - XBT, smoothed over 1000 km; errors bars are sampling error in XBTs



Ocean Surface Topography and Bottom Pressure in the Non-Boussinesq Model: What can GRACE do with El Nino?

Y. Tony Song & Victor Zlotnicki

Jet Propulsion Laboratory

Two new vertical coordinate systems

1. S-coordinate (Song&Haidvogel 1994): $z = \zeta(1+s) + h_c s + (H - h_c)C(s)$



SCRUM/ROMS (Boussinesq)

2. Sp-coordinate (Song 2003): $p = p_s(1+s) - (p'_b + p_c)s - (p_b^0 - p_c)C(s)$



Non-Boussinesq ROMS

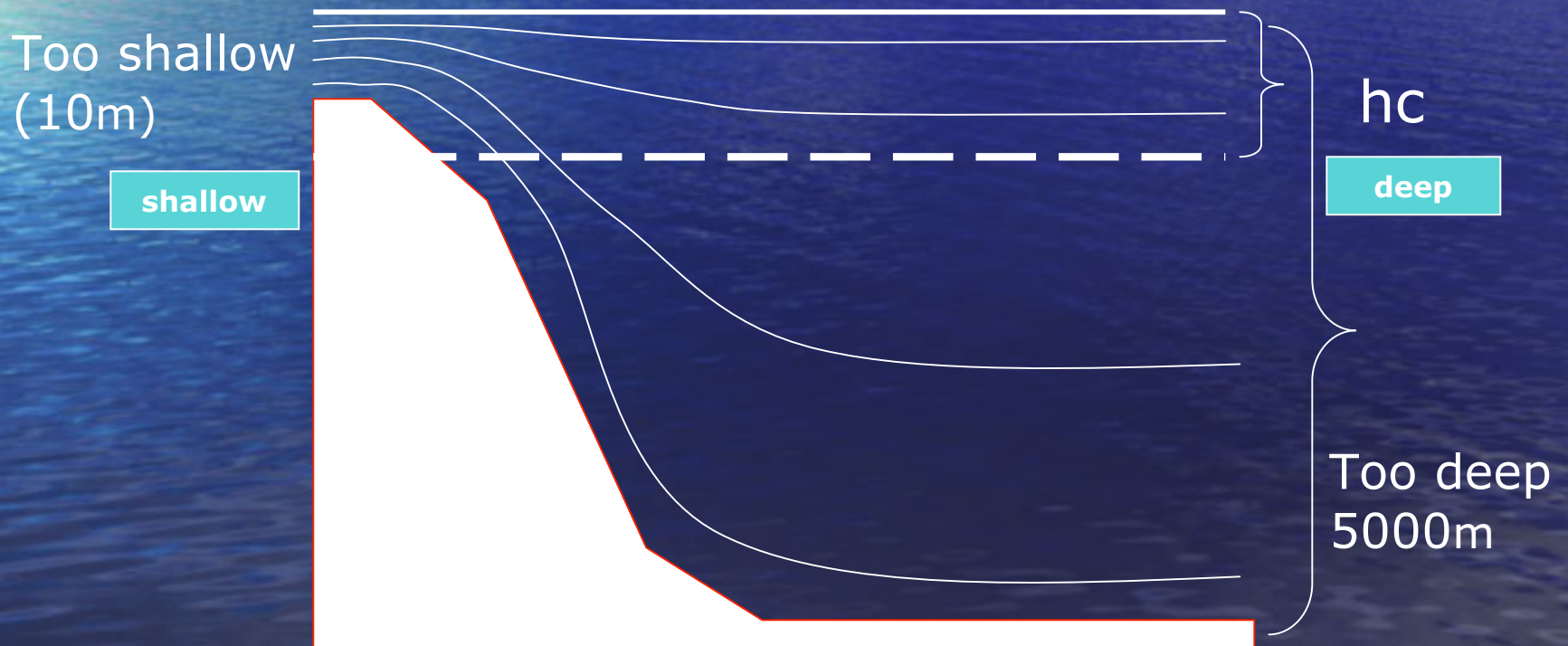

Linking Bottom Pressure to SSH

Principle:

Volume = mass/density

Method:

$$\xi = \int_{-1}^0 \{ \Delta P / g\rho \} ds - h$$

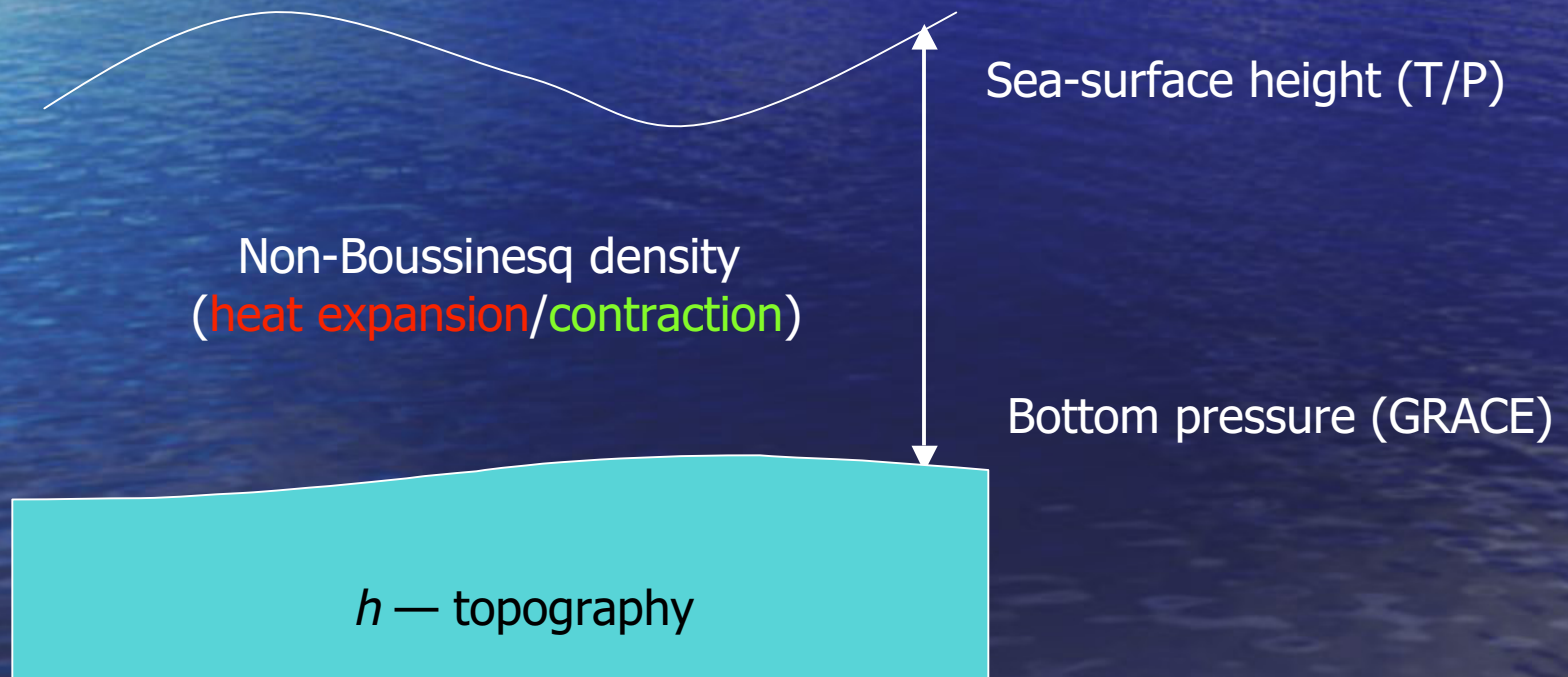

Normal years

El Nino years

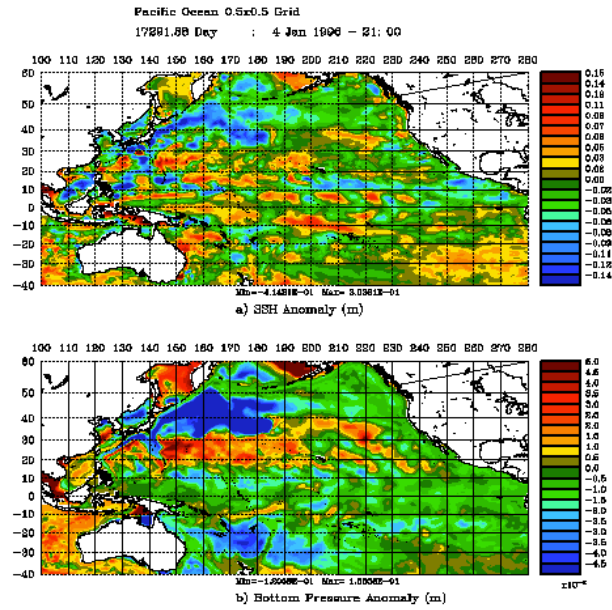

Sea-Surface Height

Ocean-Bottom Pressure

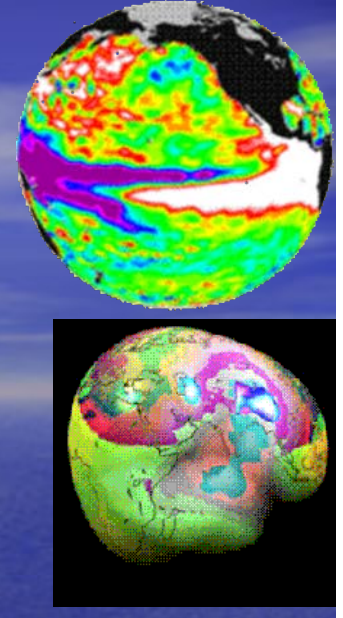

Pacific Ocean 0.5x0.5 Grid (non-Boussinesq)
17805.03 Day : 15 Jun 1997 - 00: 47

Pacific Ocean 0.5x0.5 Grid (non-Boussinesq)
17935.03 Day : 25 Oct 1997 - 00: 47

Pacific Ocean 0.5x0.5 Grid (non-Boussinesq)
18005.03 Day : 5 Jan 1998 - 00: 47

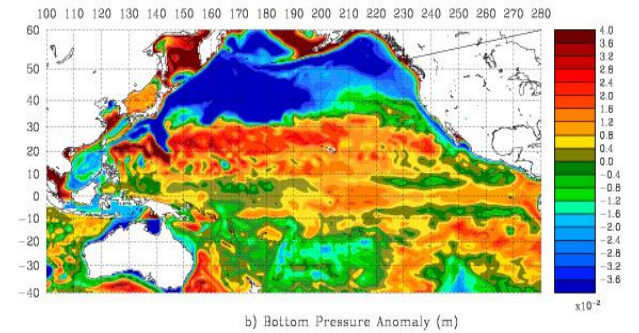
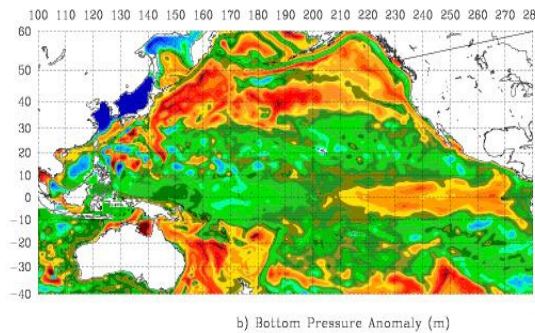
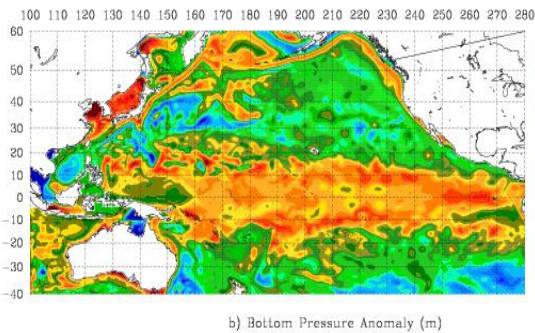
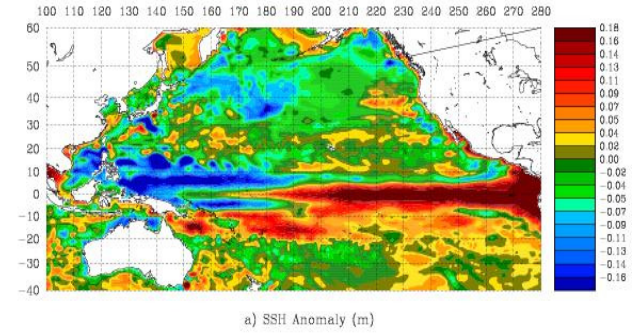
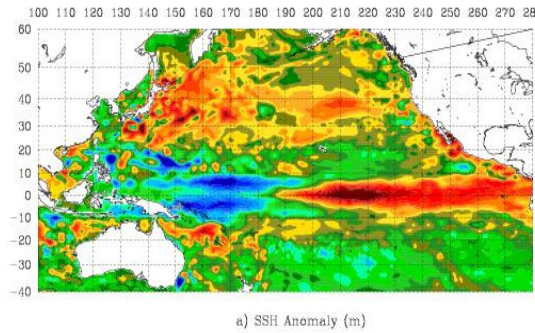
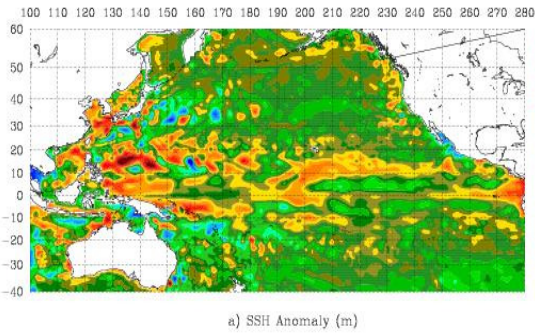

Time-Series in comparing with T/P data

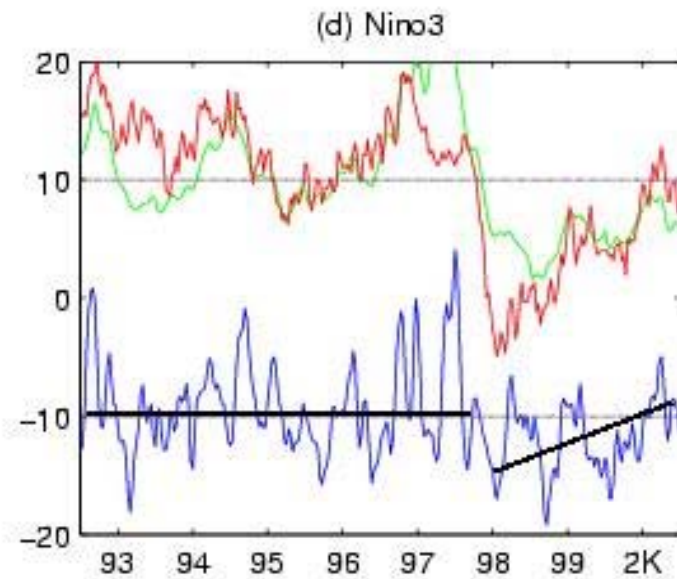
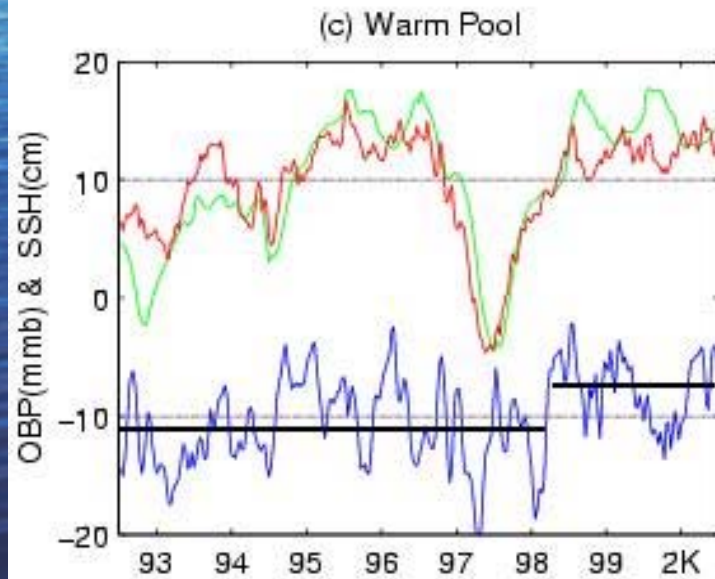
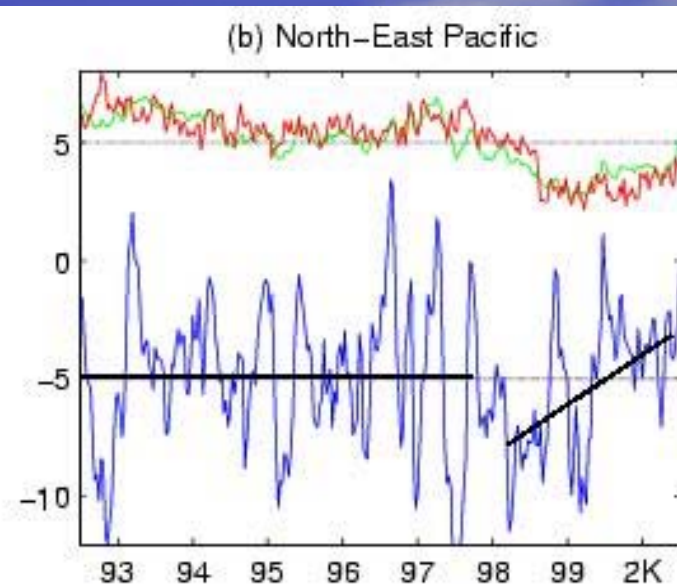
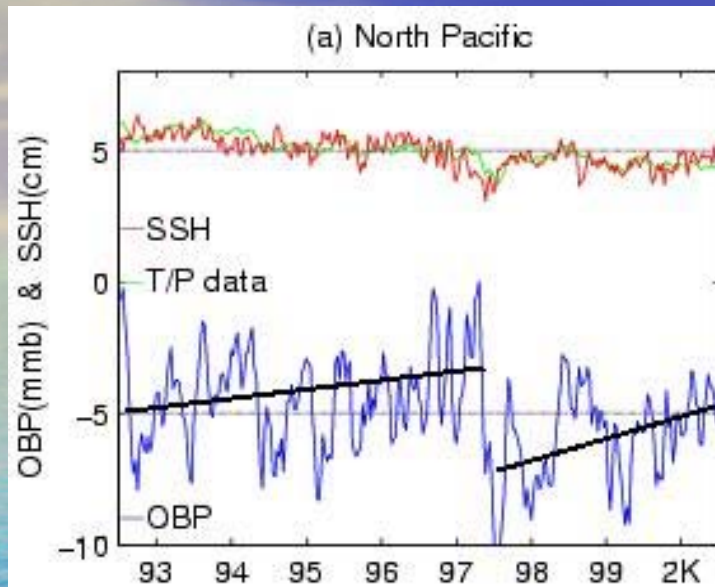

Implications

- El Nino has a profound effect on ocean bottom pressure—ocean mass distribution
- GRACE may be an indicator or another evidence (besides TOPEX/Poseidon SST) to detect or predict El Nino

This study focusing on Pacific using a new model.

- Previous studies of Greatbatch et al (2001) and Losch et al (2003) focused on global, z-level models.
- Huang and Jin (2002) focused on idealized cases and theoretical analysis.
- Many related issues: basin-wide correction, Goldsbrough-Stommel gyres, freshwater flux, and open boundaries.

Why Non-Boussinesq?

1. Boussinesq approximations without corrections are non-physical.
2. After corrections, it still has problems, more serious in regional scales.
3. Non-Boussinesq models can no extra cost comparing with Boussinesq model.

Boussinesq Corrections: $\zeta \cong \zeta_B + \zeta_E + \zeta_{GS}$

- Sea level correction (Greatbatch 1994):

$$\zeta_{Expans}(t) = -\frac{1}{Volume} \int_V \frac{\rho - \rho_0}{\rho_0} dv$$

- Bottom pressure correction (Ponte 1999):

$$p_b = g \int_{-h}^{\zeta} \rho dz + p_a \approx g\rho_0\zeta_E + g \int_{-h}^{\zeta_B} \rho dz + p_a$$

The correction has problem:

$$\frac{\partial}{\partial t} \left\{ \xi + D \frac{\delta \bar{\rho}}{\rho_0} - \xi_B \right\} + \nabla \cdot \left[\left(D \frac{\delta \rho V_B}{\rho_0} + D \frac{\rho \delta V}{\rho_0} \right) \right] = 0$$

- For a global system $\iint \nabla \cdot [\oplus] dx dy = 0$

$$\xi = \xi_B(x, y, t) + \xi_E(t) + \xi_{GS}(x, y, t) \quad \text{No spatial correction !}$$

- For a regional system $\iint \nabla \cdot [\oplus] dx dy = \oint [\oplus] \cdot \vec{n} ds \neq 0$

$$\frac{\partial}{\partial t} \iint \left\{ \xi + D \frac{\delta \bar{\rho}}{\rho_0} - \xi_B \right\} dx dy + \int_{OBC} [\oplus] \cdot \vec{n} ds = 0$$

No boundary correction !

The New Model Configuration

Reduce numerical errors by the **generalized** coordinate

Reduce representation errors by **non-Boussinesq** formulation

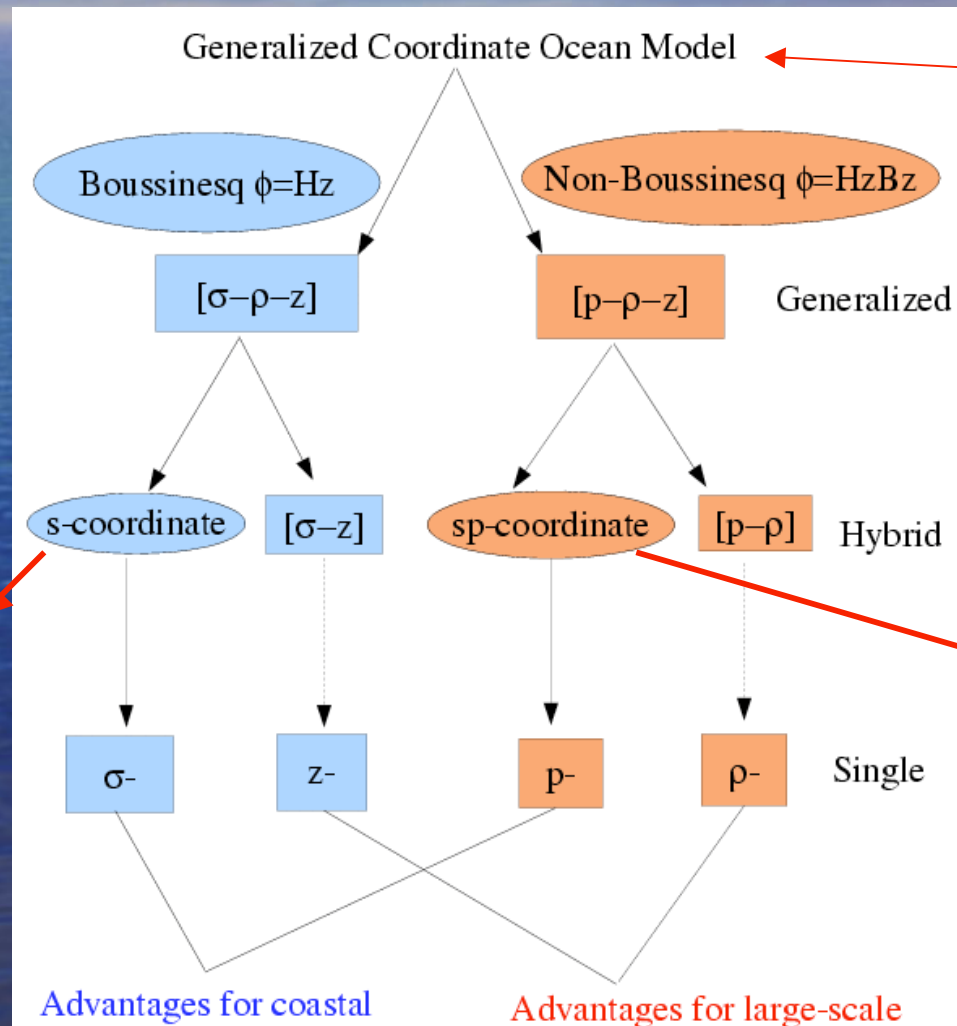

GCOM

SCRUM
(Song&Haidvogel 1994)

**Non-Boussinesq
ROMS**
(Song 2002)

JPL Compressible Ocean Model

- Topography-following and non-Boussinesq features
- Consistent with GRACE and T/P observations

Sea Surface

Heat expansion
/contraction

Bottom

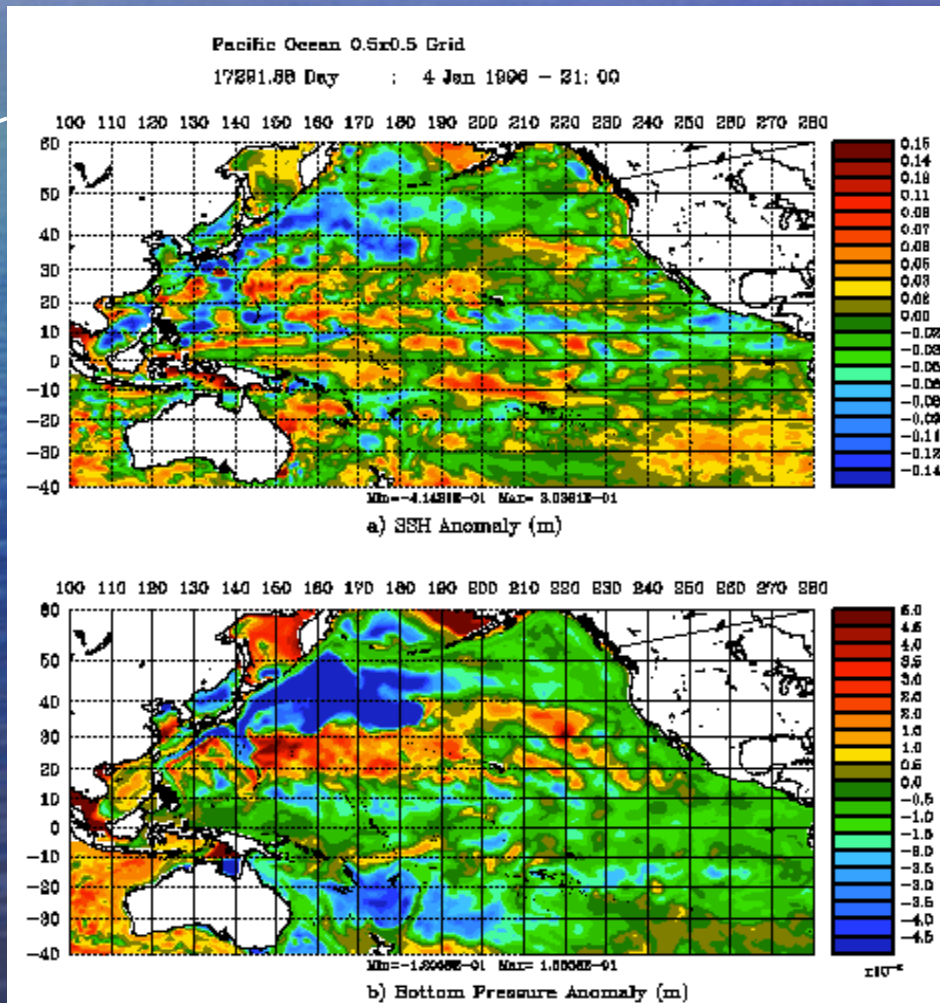

TOPEX

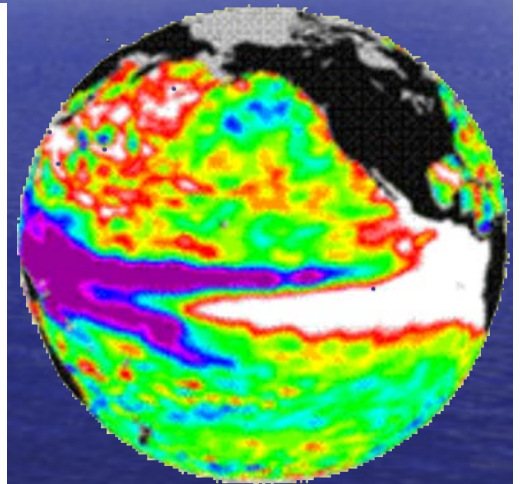

GRACE

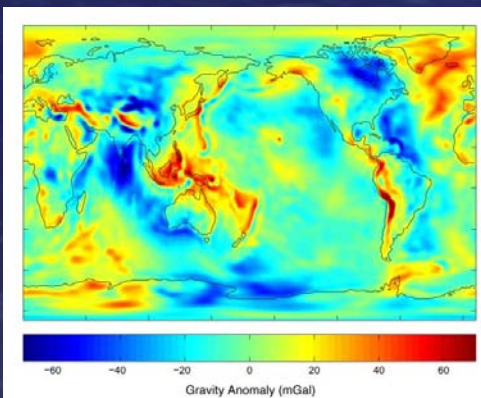

Decadal Variability in Pacific

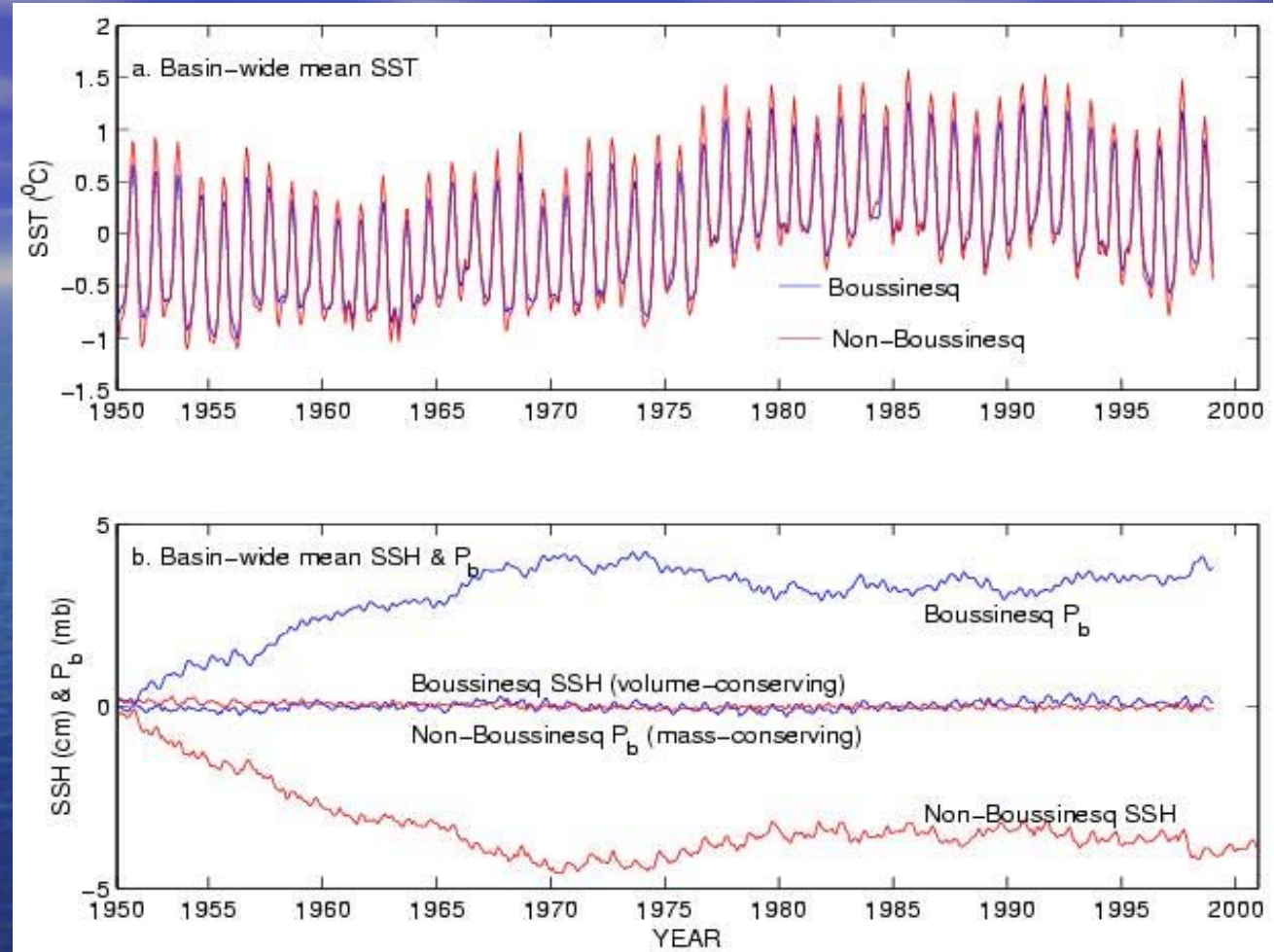
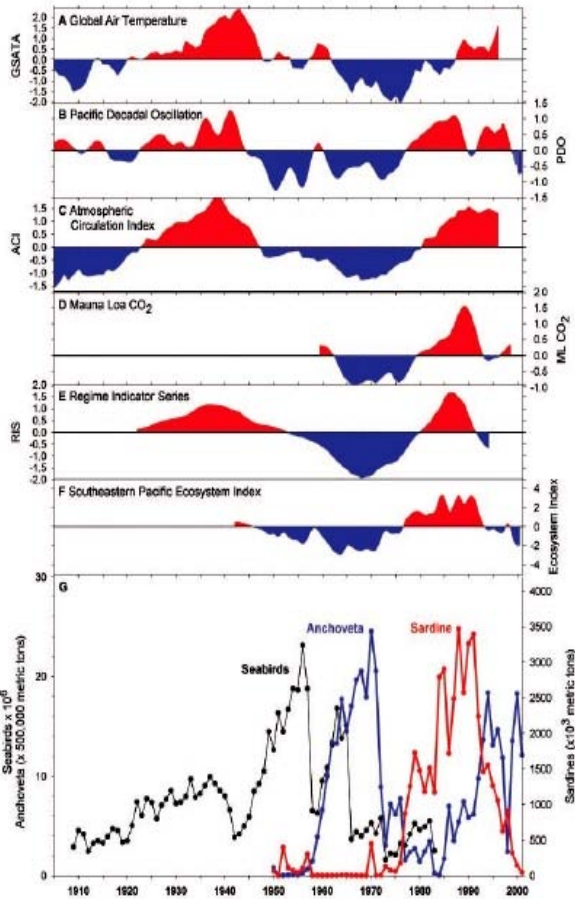
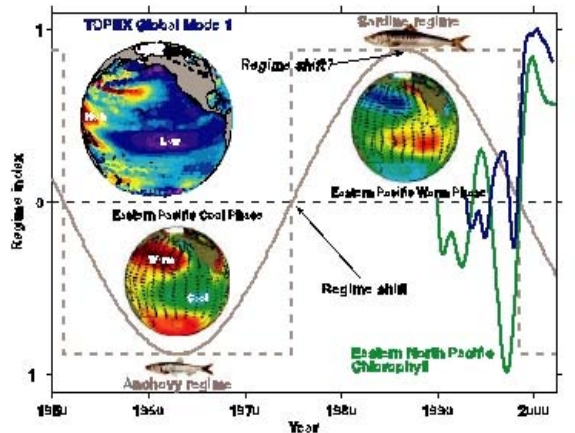

“Boussinesq models give meaningless sea-surface-elevation, bottom pressure, and angular momentum due to the lack of mass conservation”– Huang&Jin (2002).

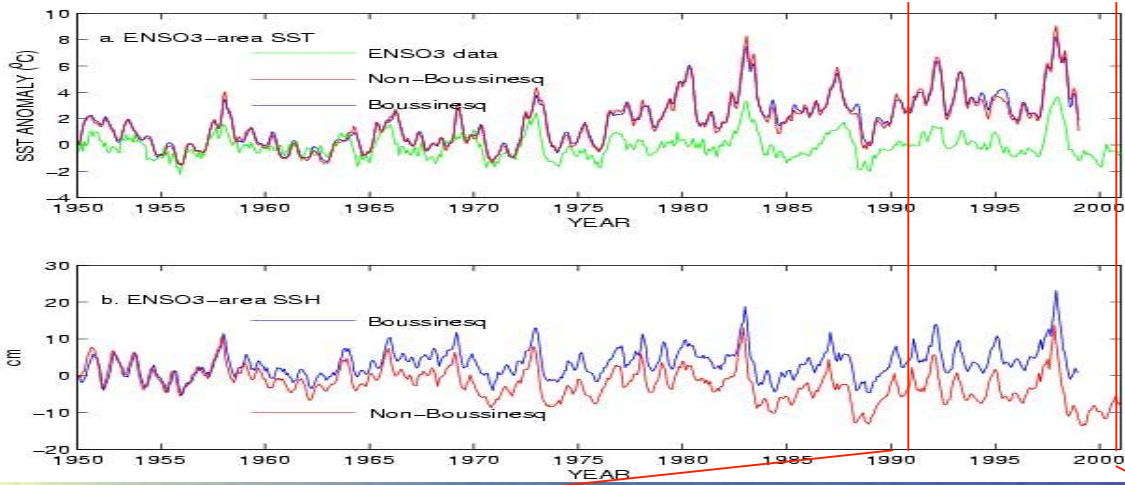

Focusing on 97-98 El Nino

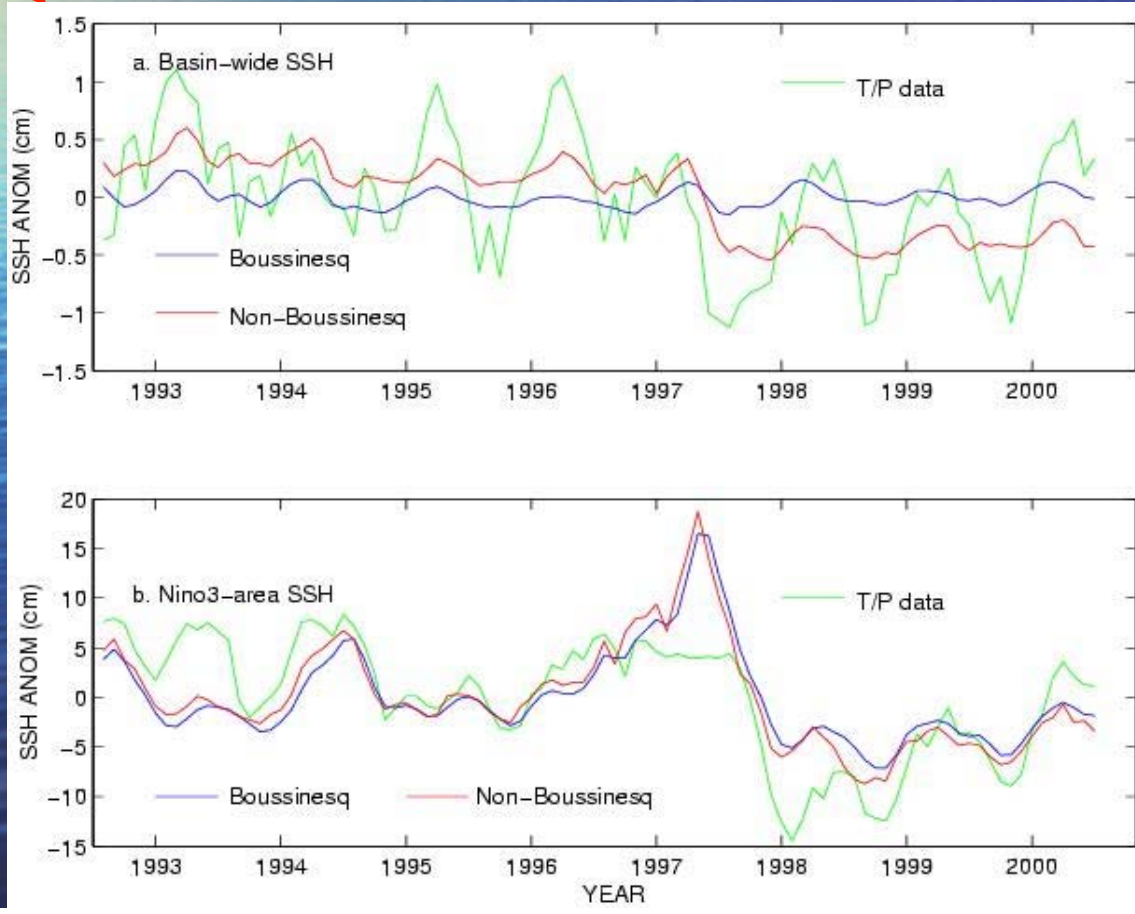

~0.5 cm basin widely

~2 cm in Nino3 index
T/P error?

Focusing on Bottom Pressure

Boussinesq error: $\sim 2\text{mb}/1000\text{km}$

GRACE error: $\sim 1\text{mm}/500\text{km}$

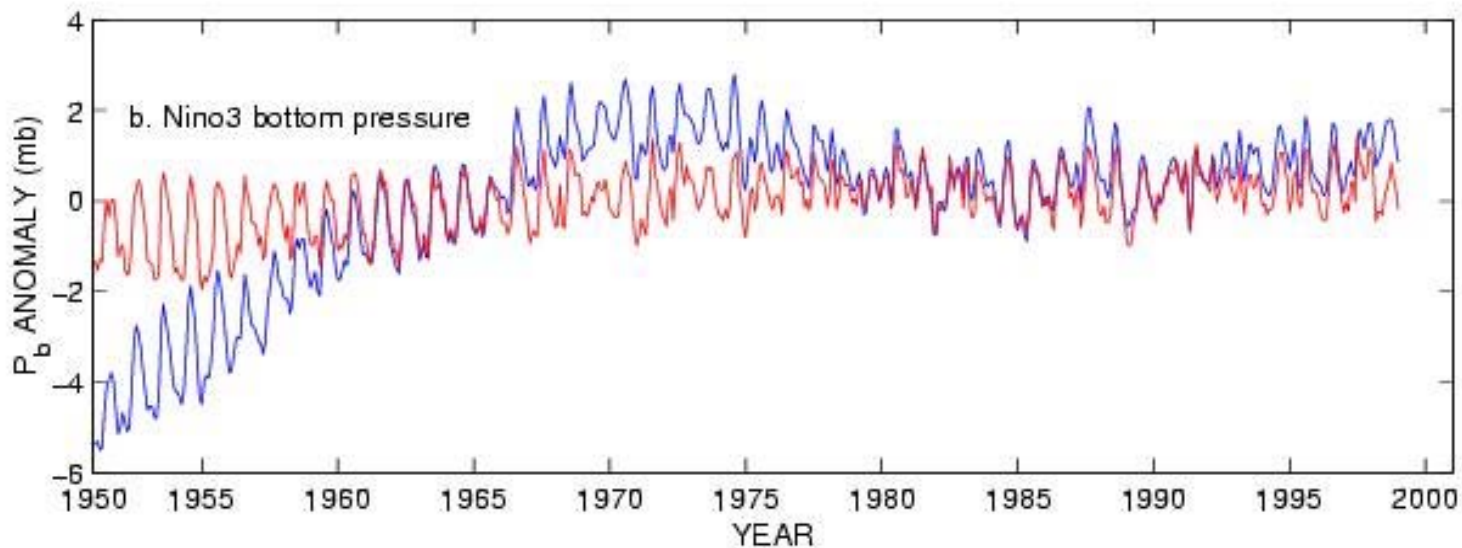
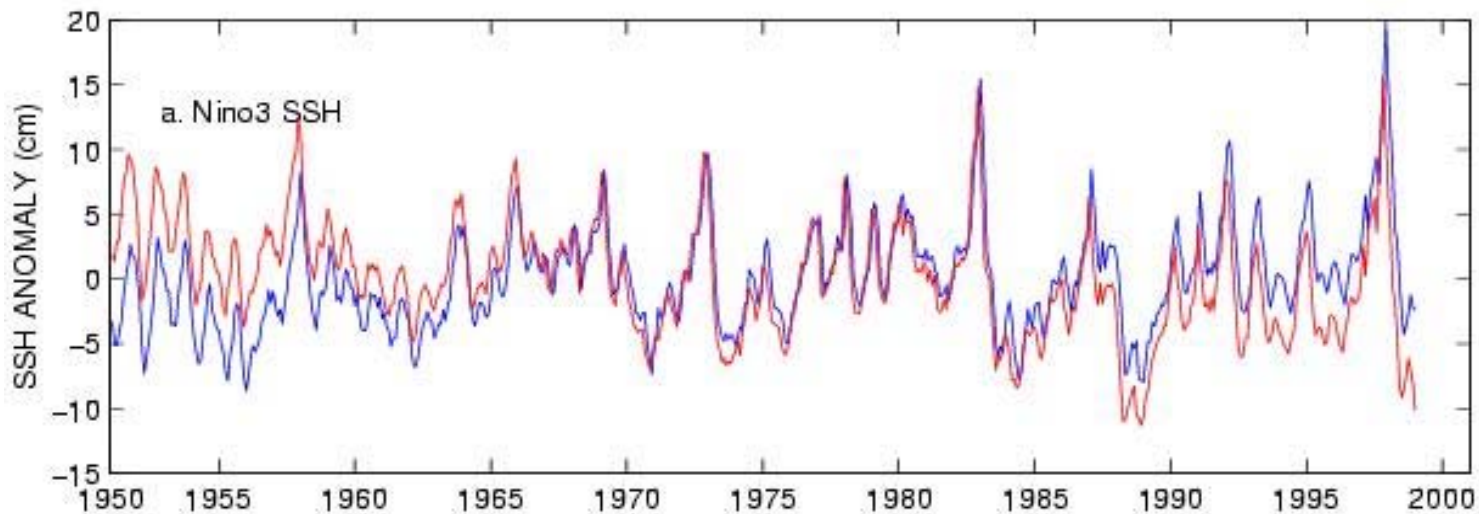

Sea-Surface Elevation

Bottom Pressure



Summary

- The new model provides a physically consistent way to link and to interpret T/P & GRACE measurements.
- It provides a better tool to study ocean dynamics in conjunction with T/P and GRACE data.



TIDES FOR AND FROM GRACE



R. Ray¹, G. Egbert², F. Lemoine¹, D. Rowlands¹

1. NASA Goddard Space Flight Center

2. Oregon State University

- 1. Develop comprehensive ocean tide model for GRACE analyses.**
 - a) High-degree spherical harmonic expansions on ellipsoid
 - b) Improve numerical models in polar seas (incl. temporal variability)
 - c) Variable ocean density
- 2. Develop air tide models complementary to non-tidal corrections.**
 - a) S1, S2, S3, ... and temporal variability
- 3. Investigate estimating long-wavelength tides from GRACE data.**
 - a) Solar tides are problematic owing to unfavorable aliasing.
- 4. Employ inverse methods for comprehensive fit to altimetry + GRACE data + hydrodynamics.**



**Proudman
Oceanographic Laboratory**
NATURAL ENVIRONMENT RESEARCH COUNCIL

UK GRACE-related studies

Chris W. Hughes, Vladimir Stepanov, Philip Woodworth
(Proudman Oceanographic Lab.)

Philip Moore, Chris Kilsby (Newcastle University)

Keith Haines and Rory Bingham (Reading University)

Global Barotropic Ocean Model

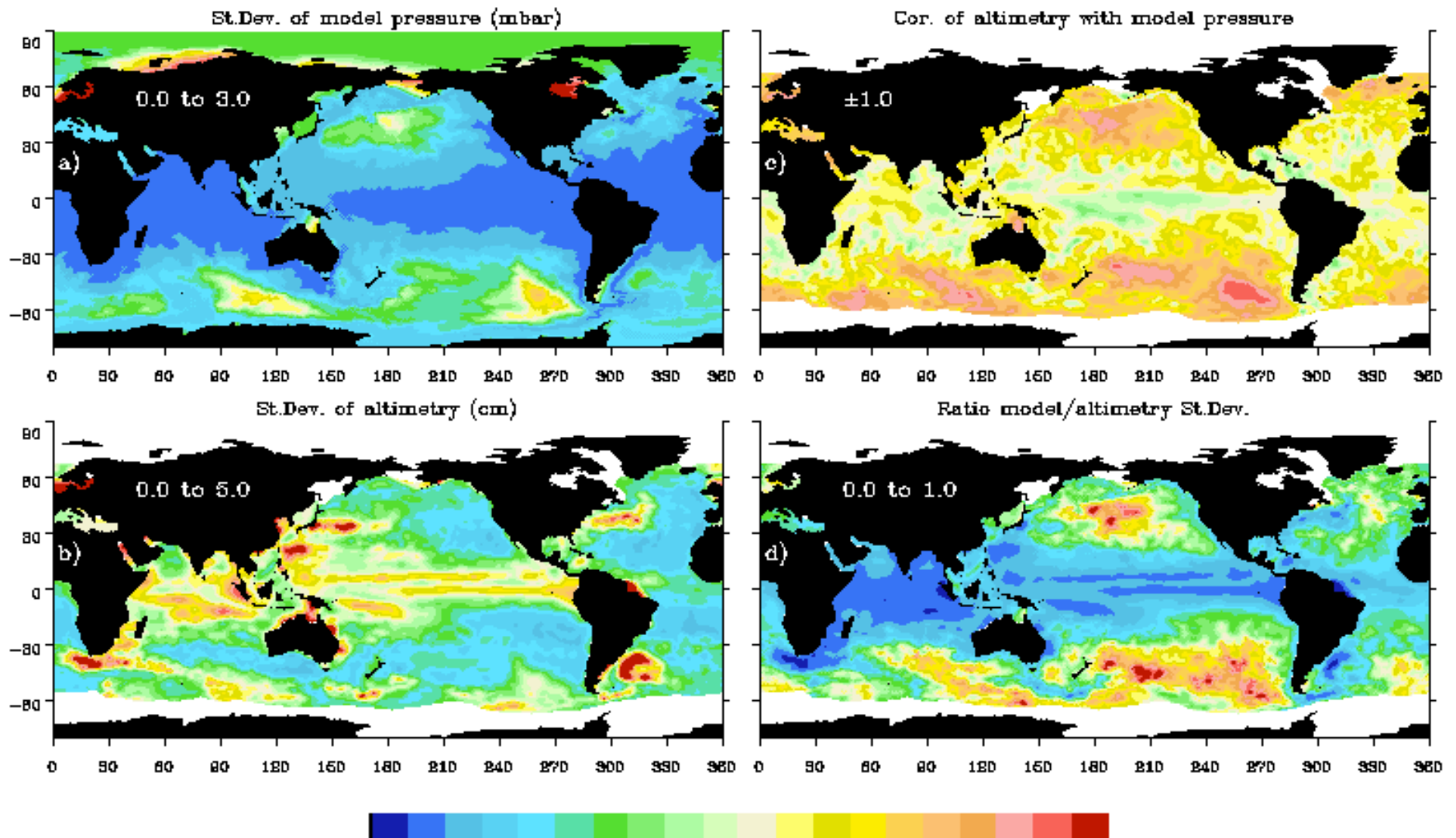

Ocean self-attraction and loading

Model errors due to missing these effects

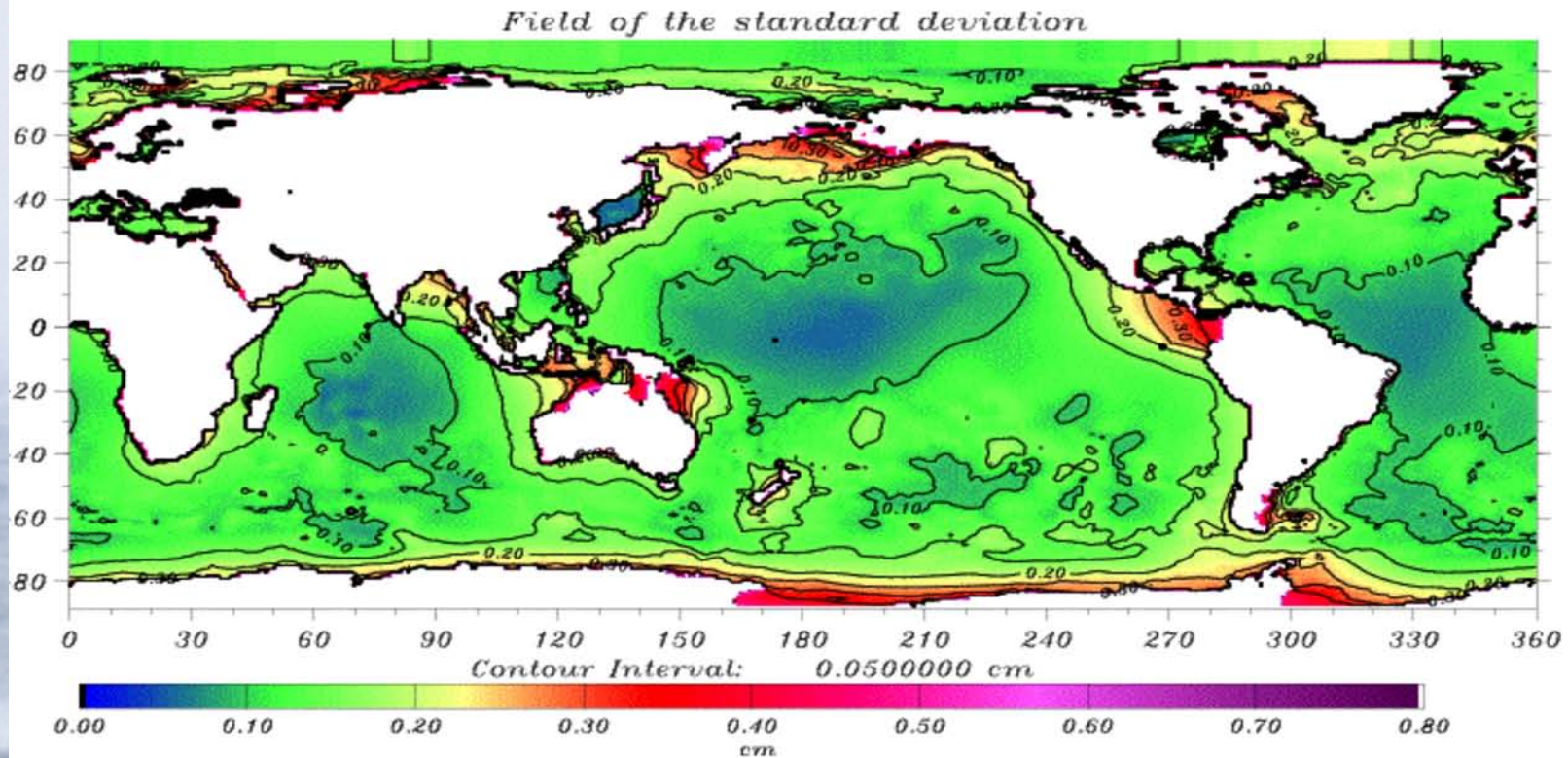

Ocean self-attraction and loading

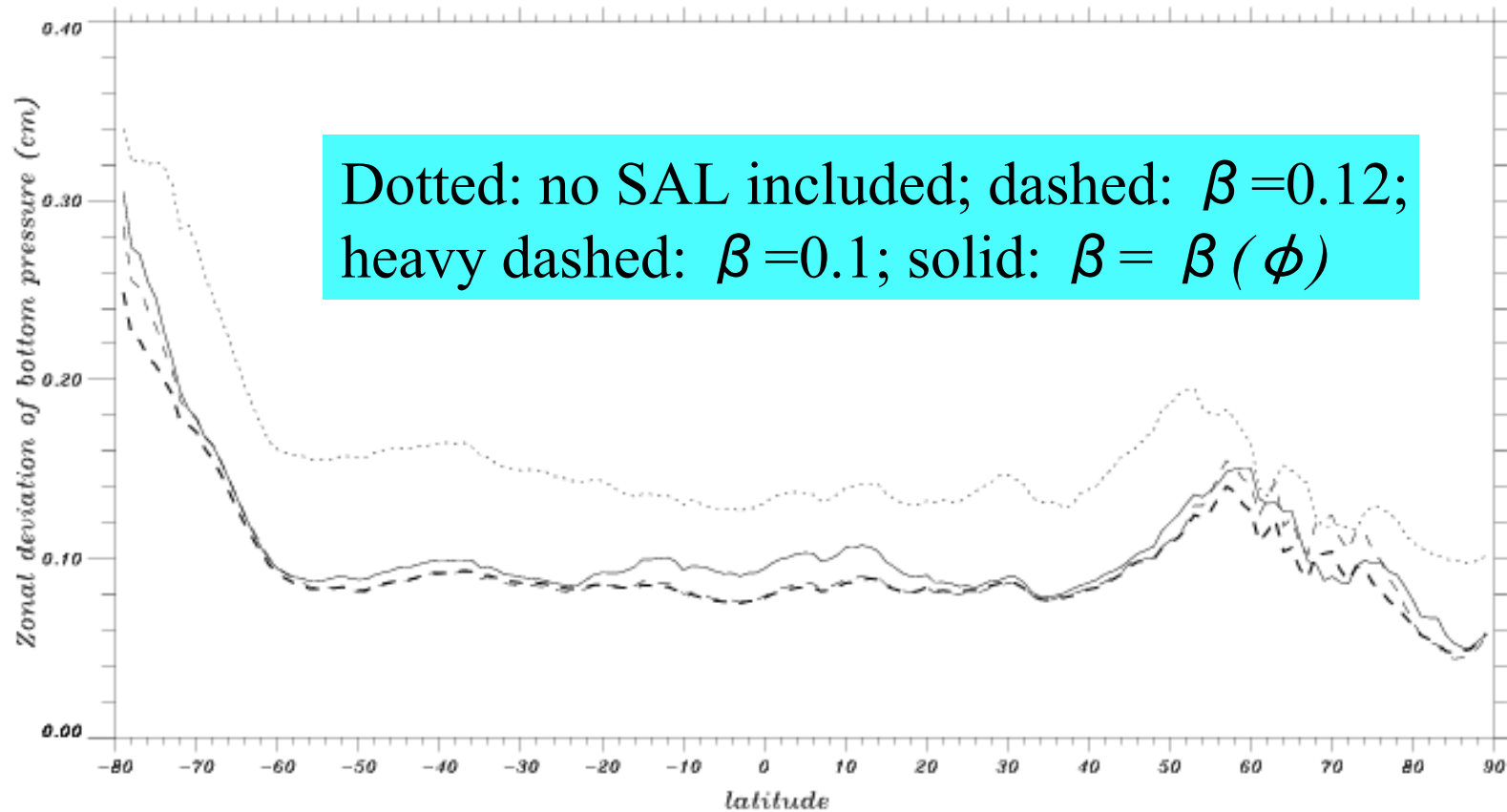

J₂ Variations

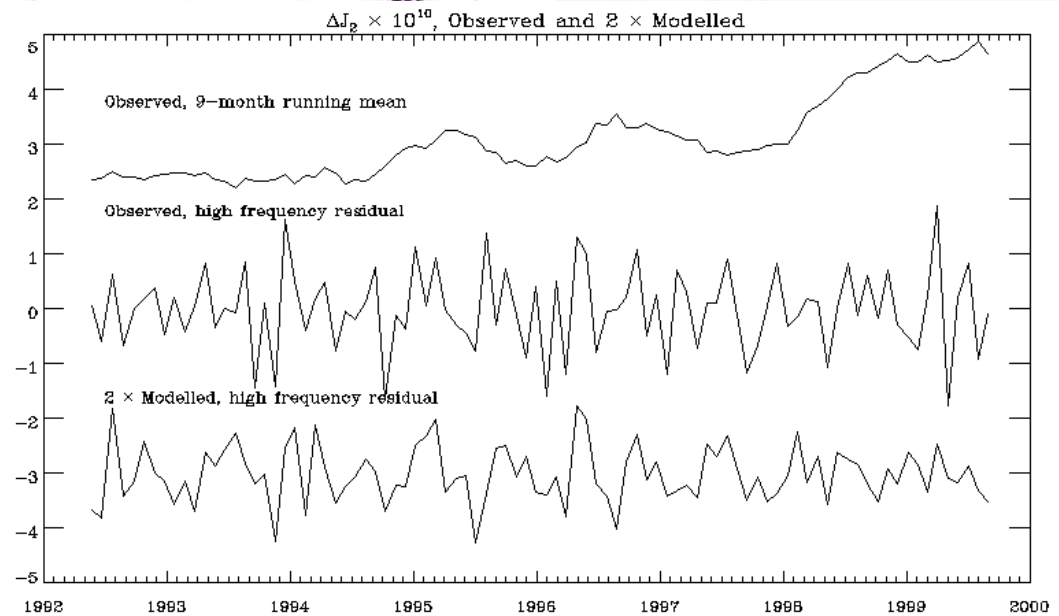
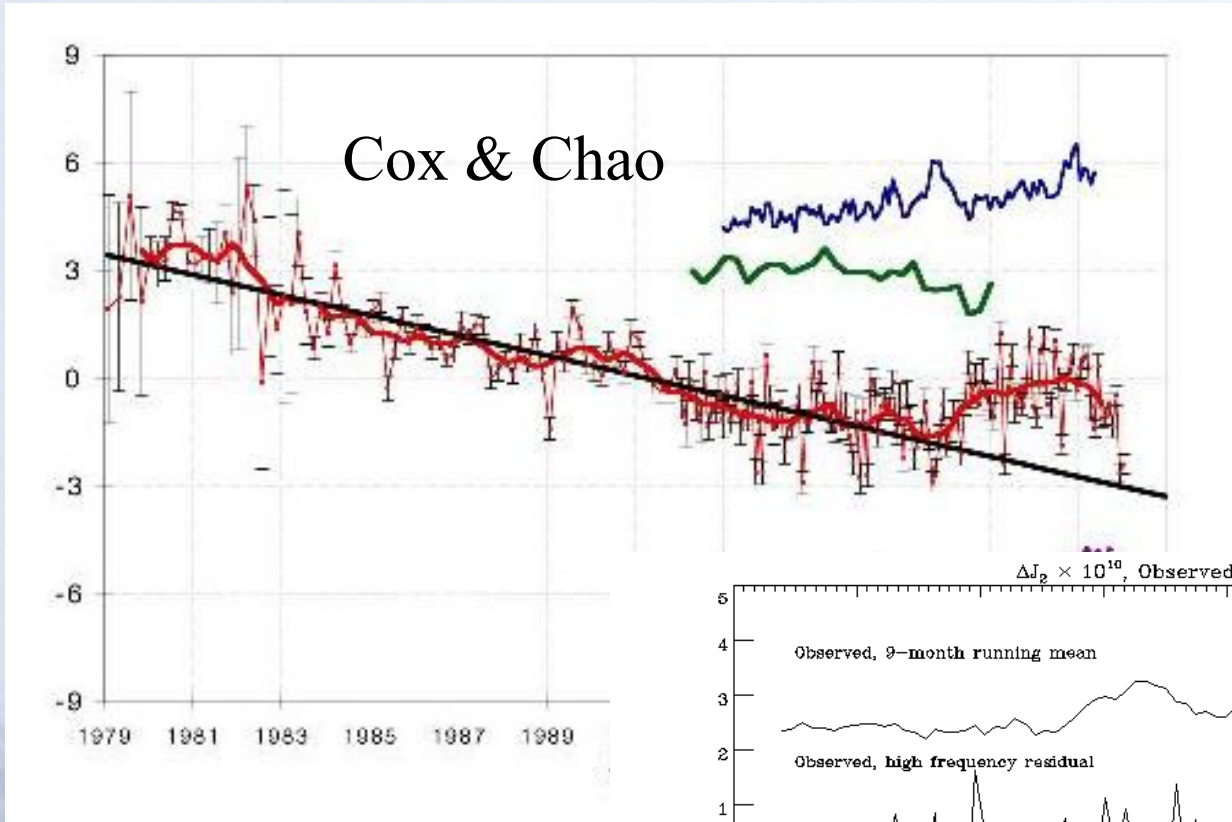

J₂ Correlations

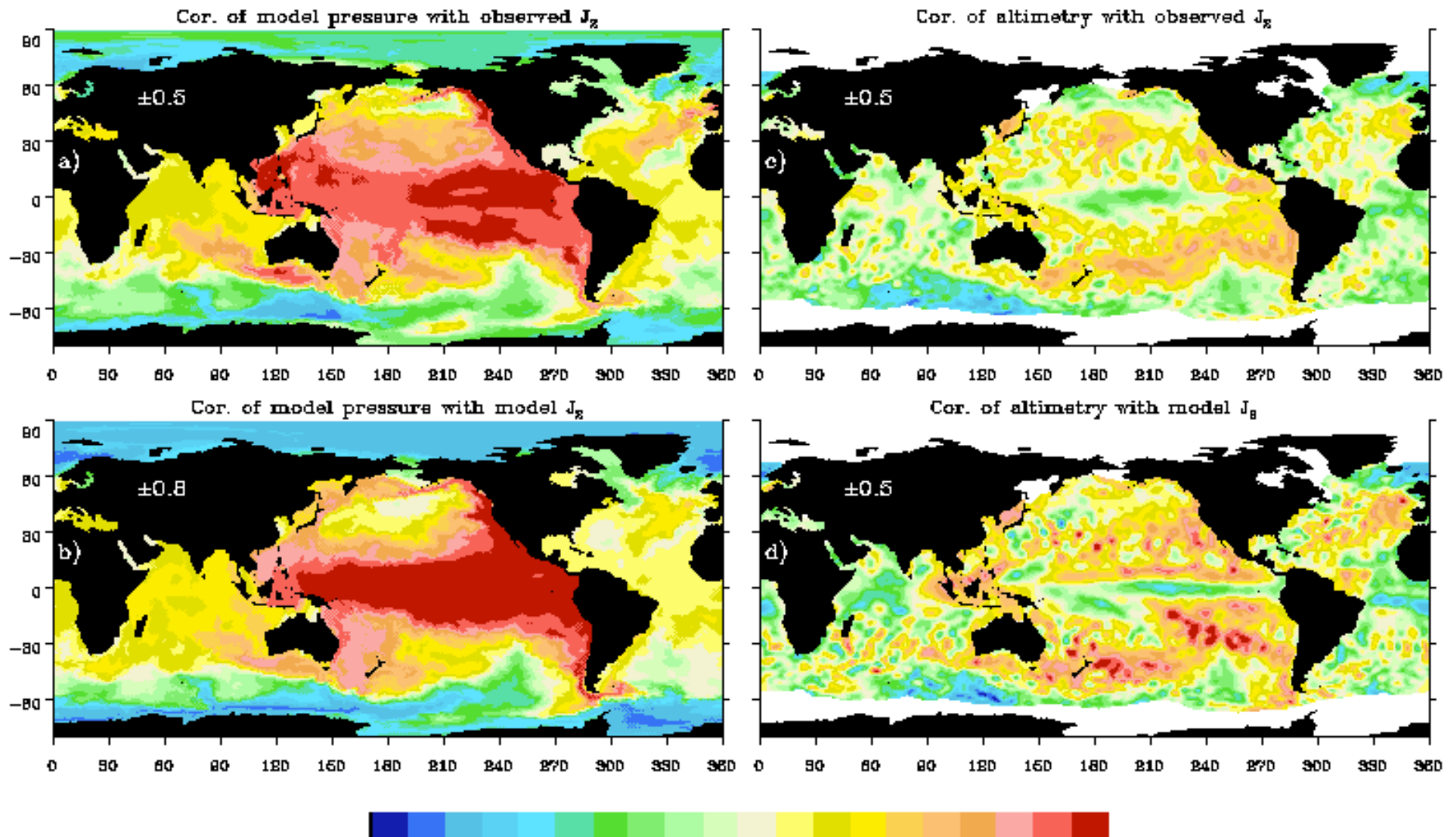

Arctic and Antarctic modes

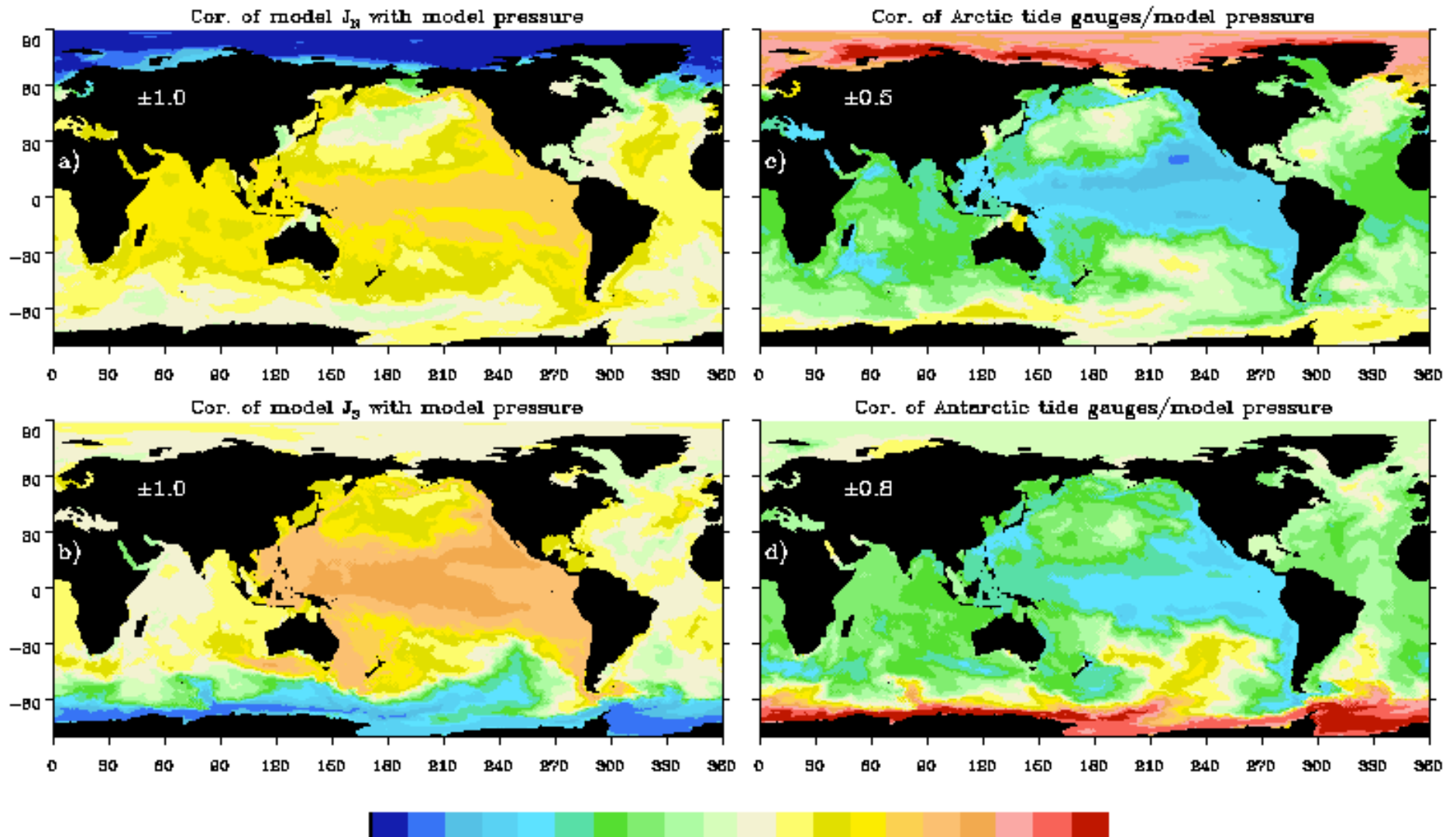

Long period Arctic

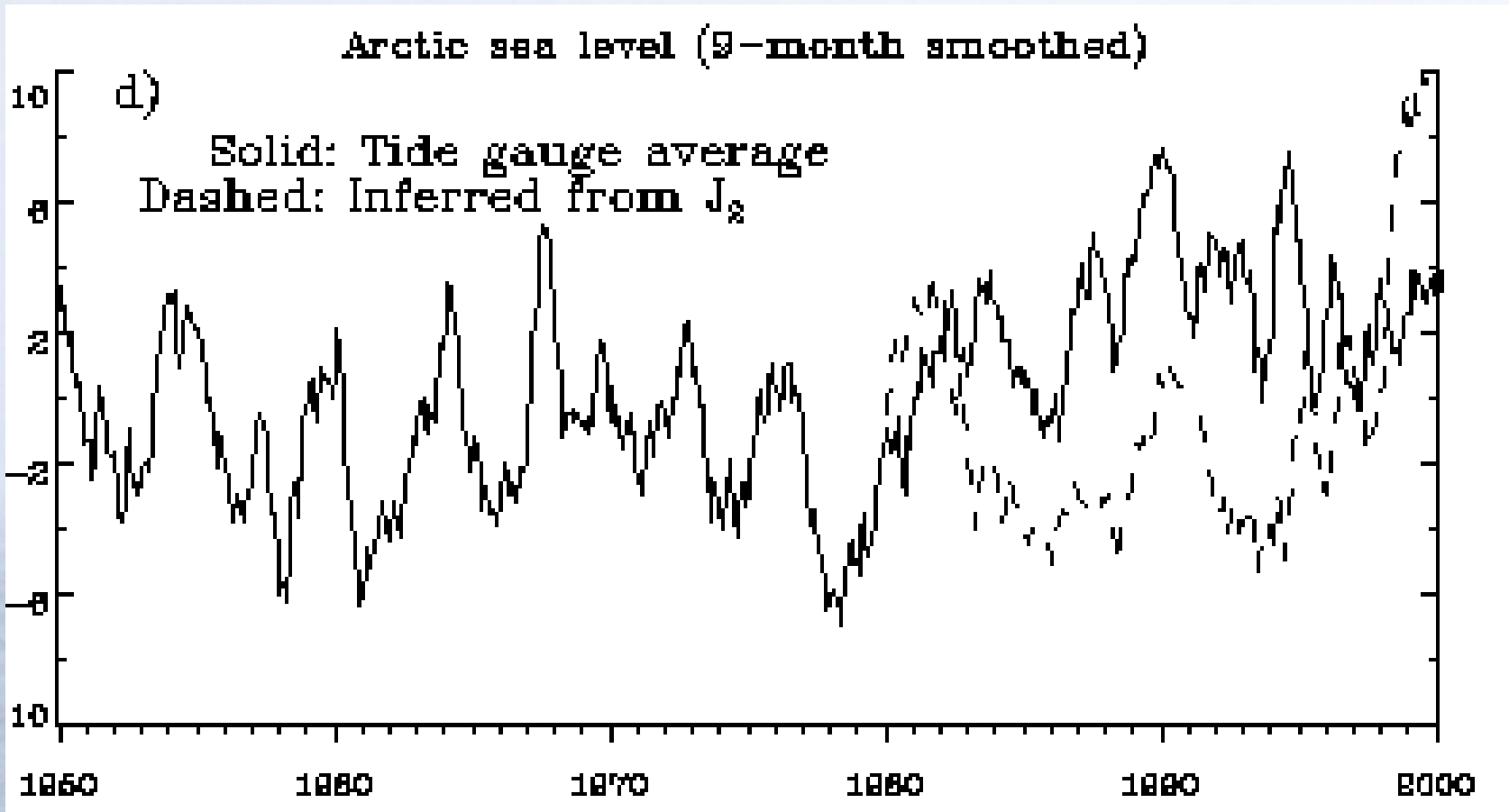

Long timescale modelling

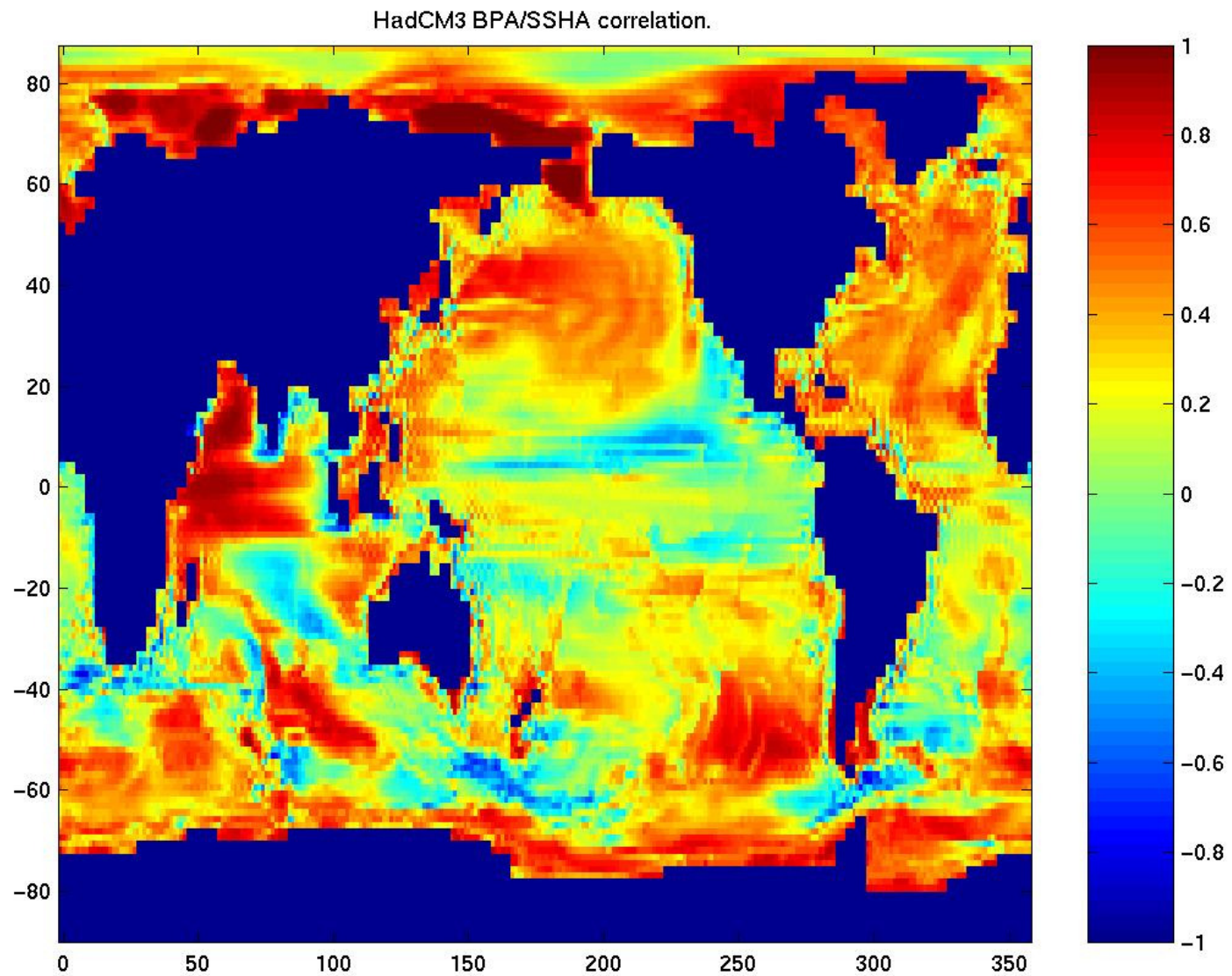

2002 Bottom Pressure measurements: Argentine Basin

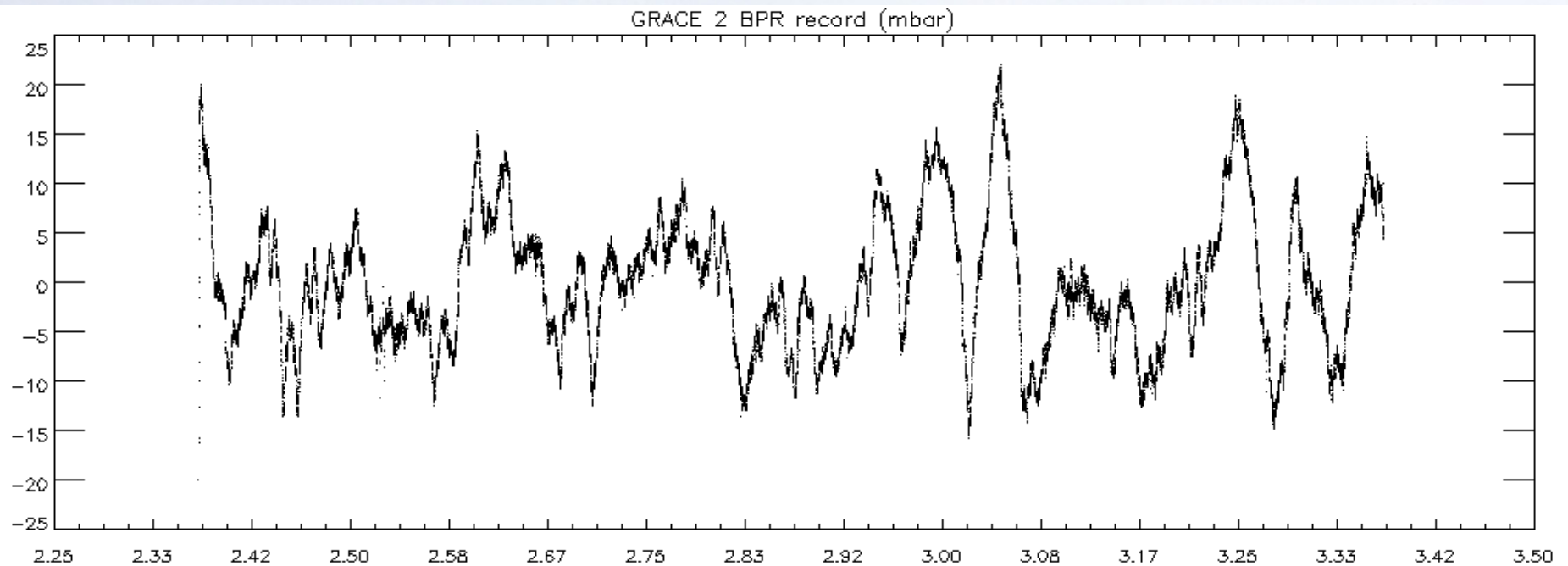

Cf. Lee Fu Altimetry

Future measurements: RAPID

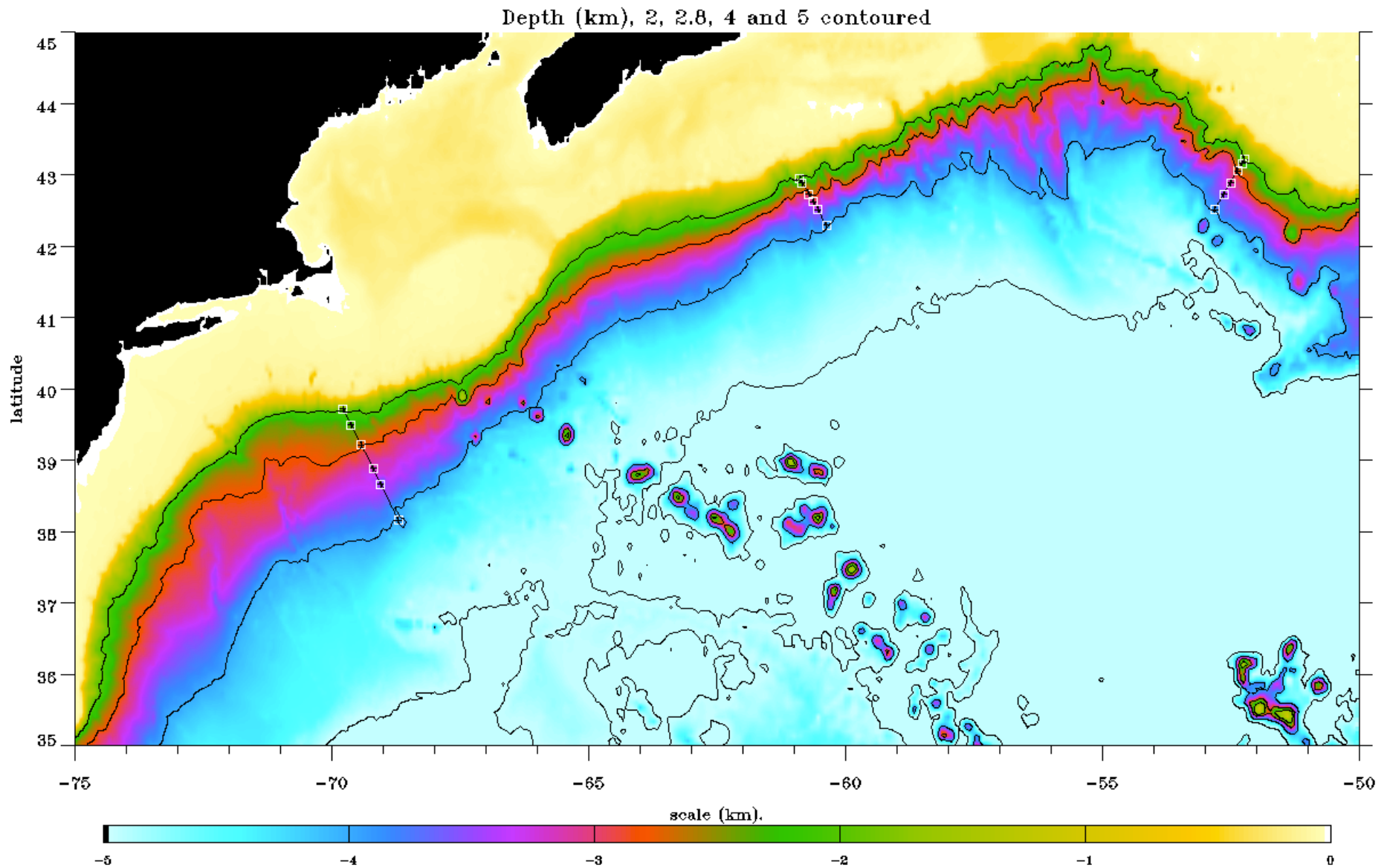

RAPID

Mooring Schematic for Grand Banks section

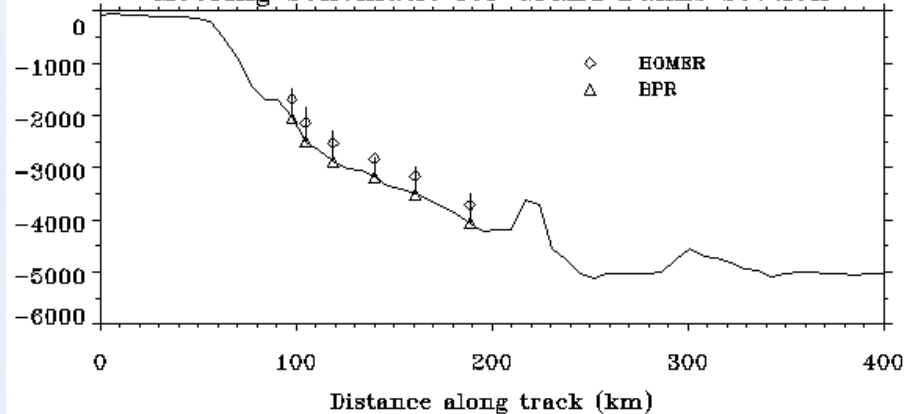

Mooring Schematic for Halifax section

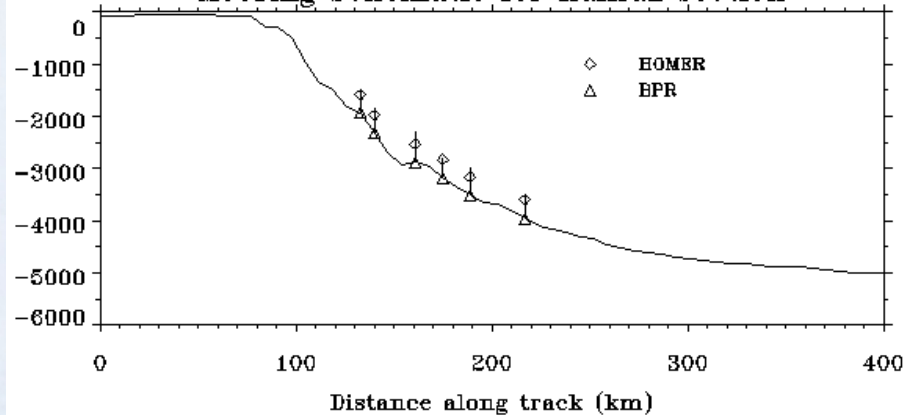

Mooring Schematic for WHOI Section

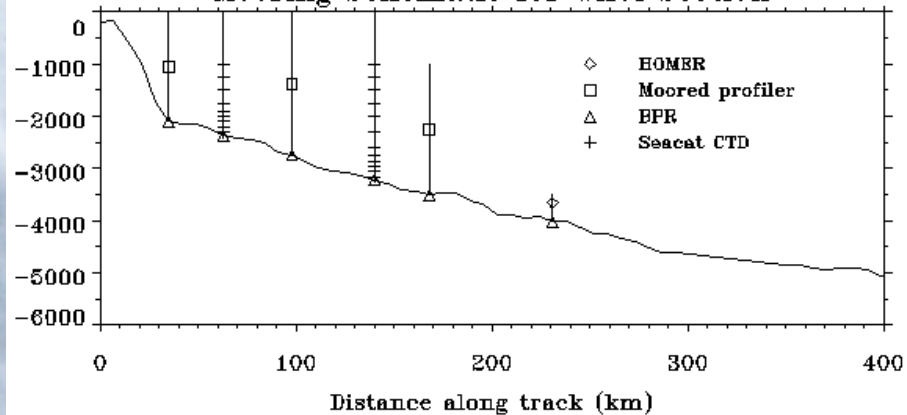

Future Plans

- Orbit modelling based on model data
- Identification of patterns in orbit data related to errors in ocean (and other) models
- Strategy to filter out high frequency aliasing errors
- Further model diagnostics – learning what large scale ocean bottom pressure tells us about ocean dynamics.
- Exploration of implications for hydrology

Comparison of geopotential height from SAC-C, CHAMP and GRACE occultation data and from Global Circulation Models for GRACE De-Aliasing

PI: Isabella Velicogna, University of Colorado

Co-I: George Hajj, JPL, NASA

We propose to:

- Test for errors in the ECMWF numerical model outputs, particularly in the polar regions and over the southern hemisphere, by comparing occultation measurements with GCM estimates of atmospheric mass.
- Evaluate the uncertainties associated with converting refractivity structure to geopotential height, and examine whether algorithms for this mapping can be improved by exploiting stochastic properties of atmospheric variables and/or in situ measurements of pressure.
- Compare geopotential heights from SAC-C, CHAMP and GRACE occultation data with ECMWF geopotential heights.
- If the differences are large and can be confidently attributed to errors in the ECMWF geopotential height fields, we will examine whether occultation data can be used to improve the GRACE atmospheric mass correction.

PROPOSAL MOTIVATION

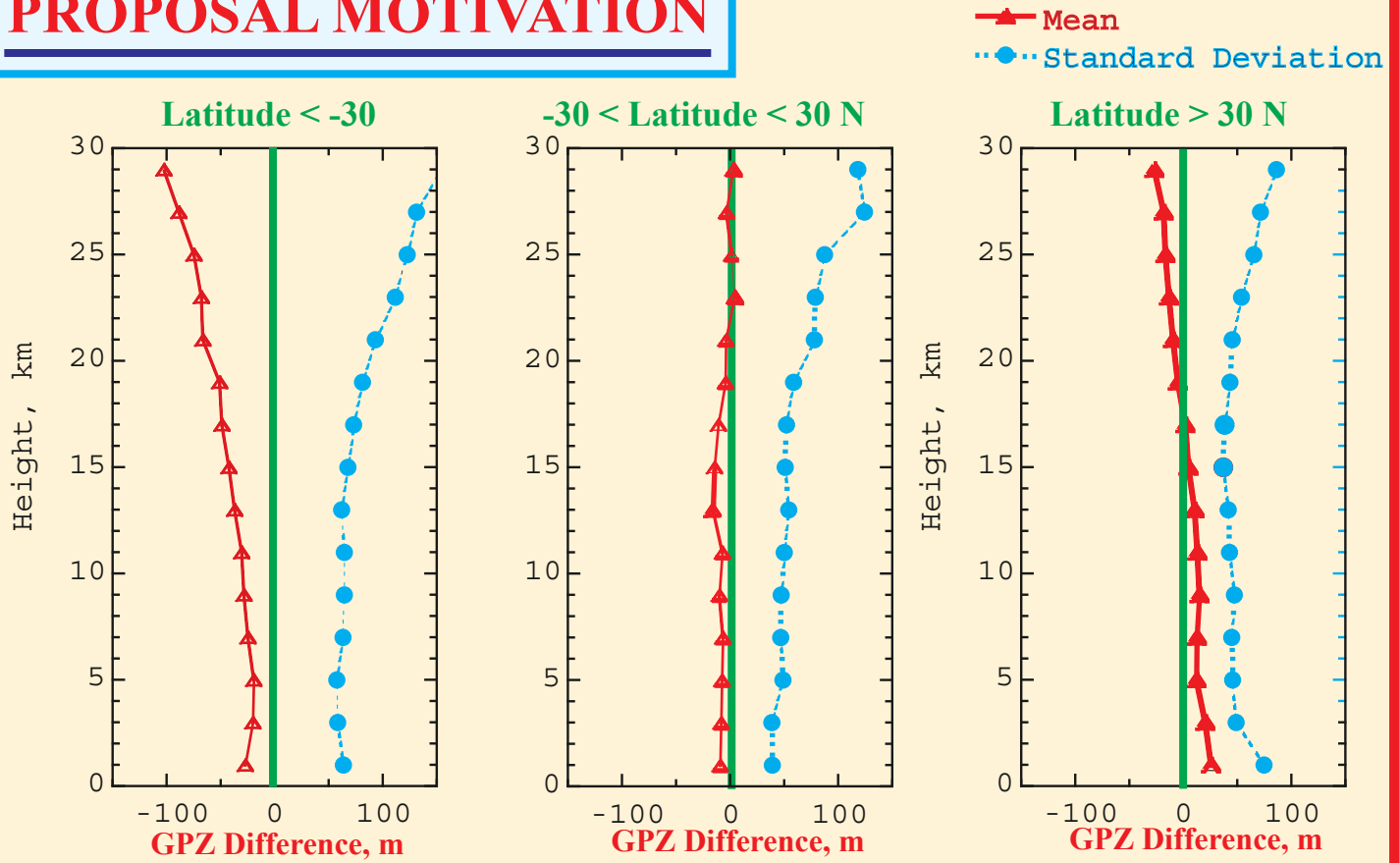

Refractivity Differences

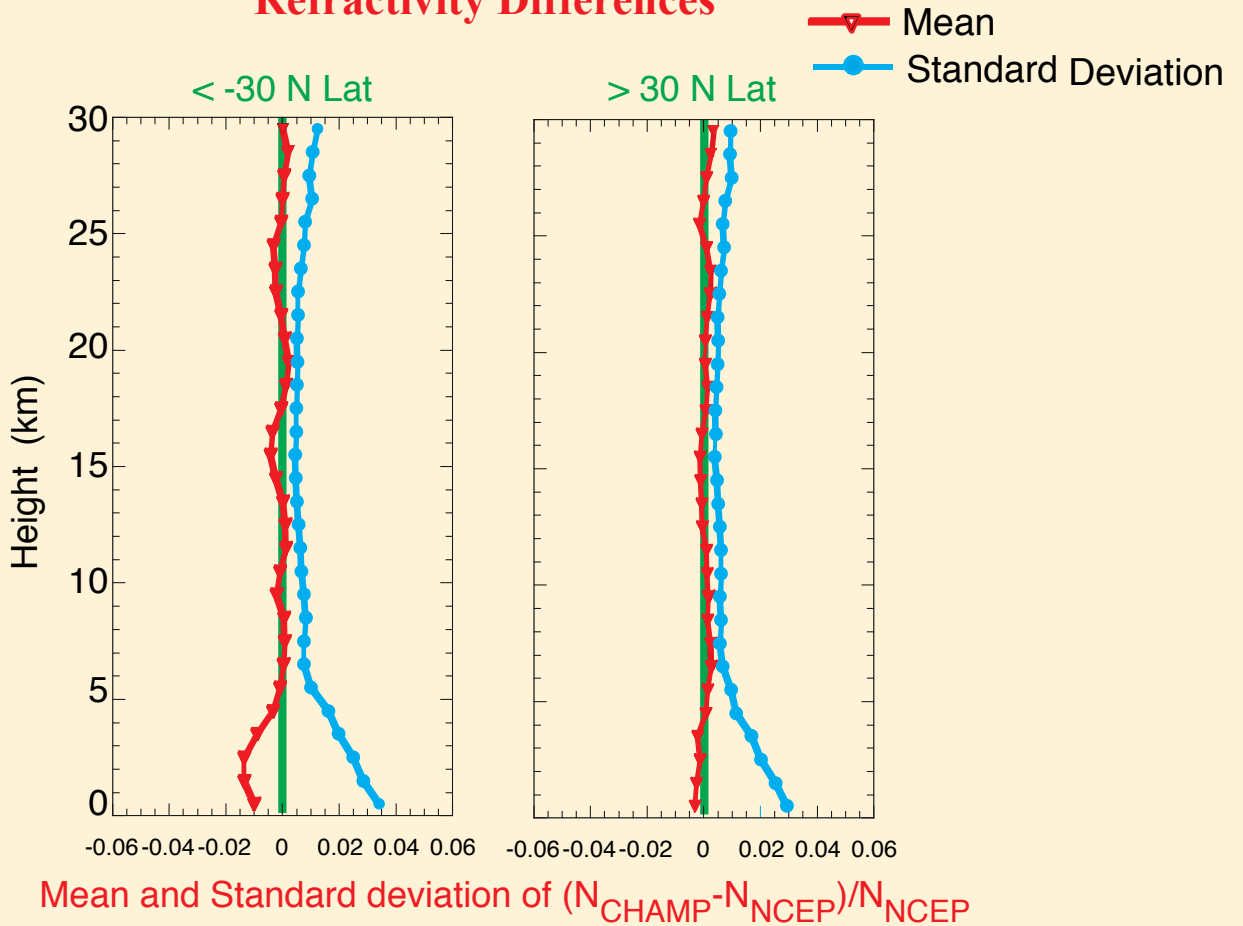

CHAMP AND SAC-C OCCULTATION COVERAGE

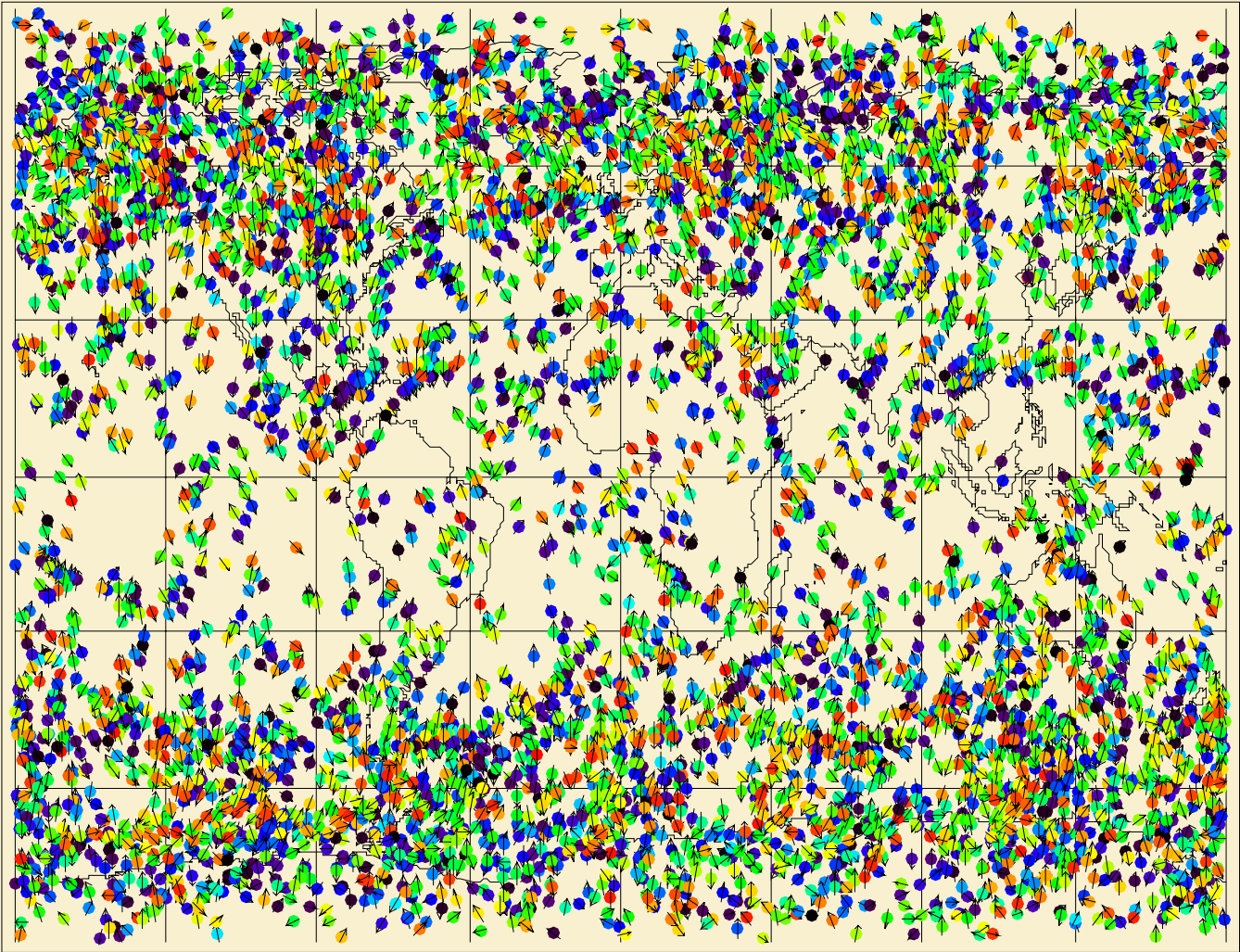

Occultations collected during a 1 month period (24 September to 24 October) in 2001 include 3000 successful CHAMP occultations and 5000 SAC-C occultations.

Sampling is densest at high latitudes, primarily because of orbital geometries.

Why the Polar region ?

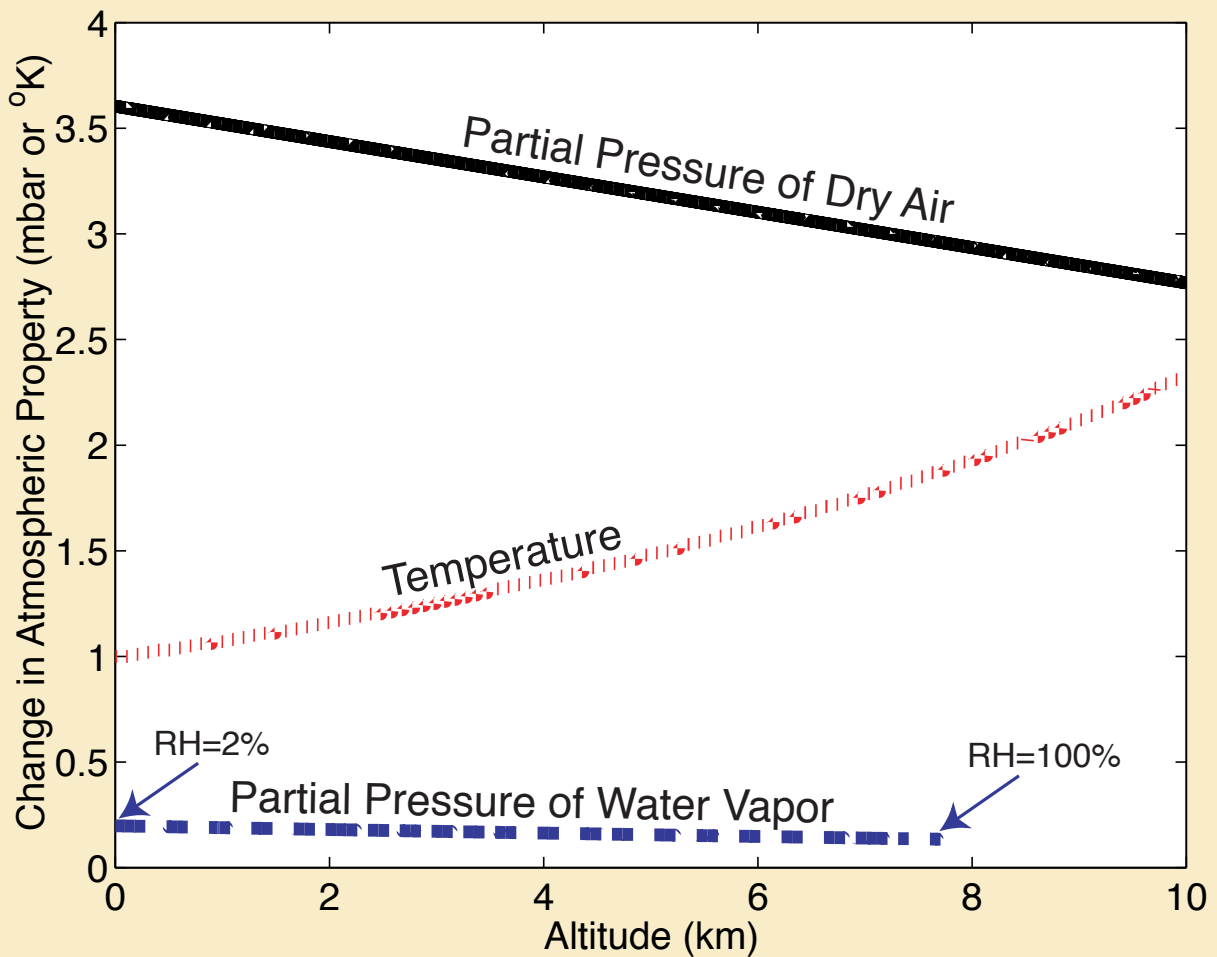

Change in Parameter, relative to a simple dry reference atmosphere, that is required to generate 1 N-unit change in refractivity

Based on a surface temperature $T = 10^{\circ}\text{C}$ →

→ **Note:** in polar regions during the winter months, the same specific humidity would correspond to nearly 100% relative humidity.

→ **Consequently, polar regions in winter will have no dry/moist ambiguity.**

Separation of GRACE Data into Atmospheric and Oceanic Components

Francis Condi

Tatyana Pekker

Jianli Chen

Center for Space Research

University of Texas at Austin

GRACE STM OCT. 8-10, 2003

Motivation

- Components are useful for geophysical/scientific studies, e.g. as constraint in assimilation
- Better force modeling in the future for operational work

Items for Study

- Investigate methods for separating data into atmospheric and oceanic components.
- Produce components with estimates of uncertainty.
- Assess current operational procedures in light of results.

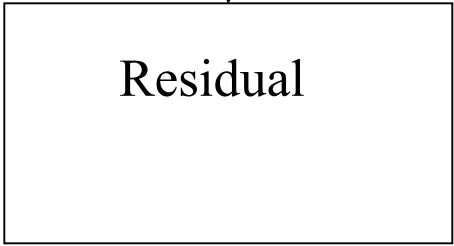
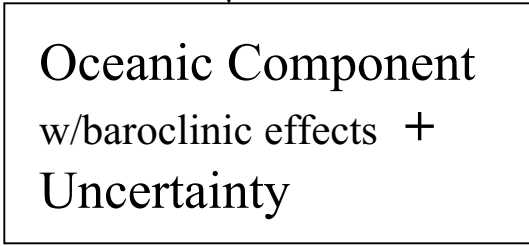
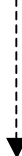
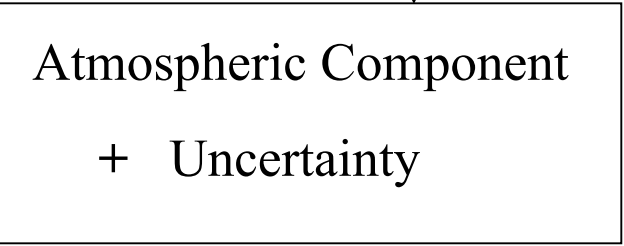
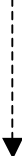
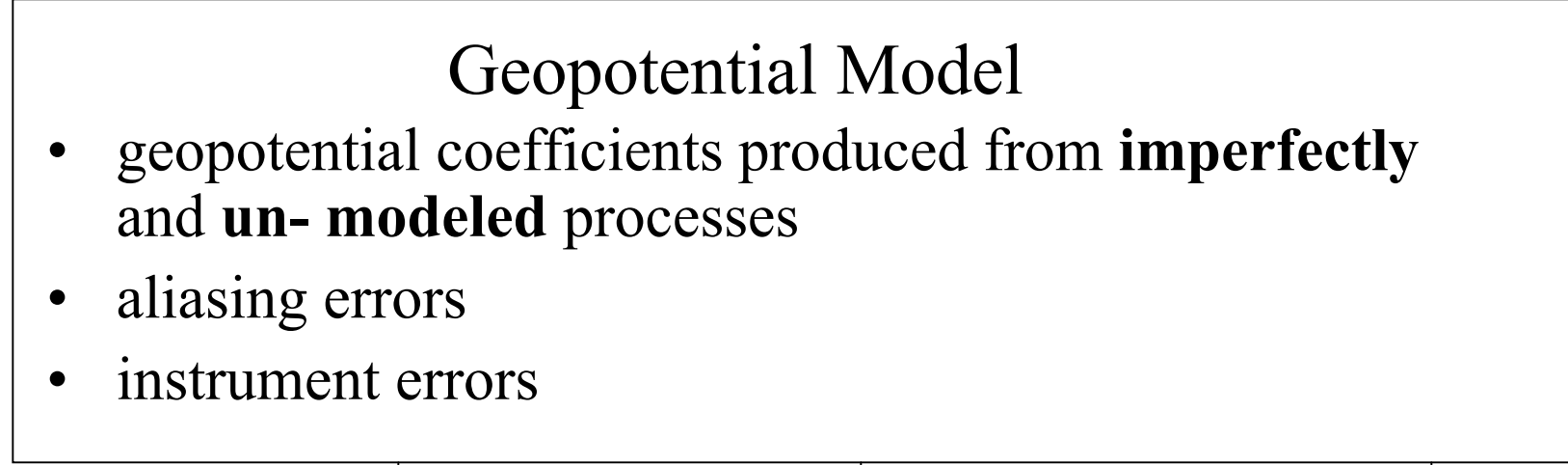
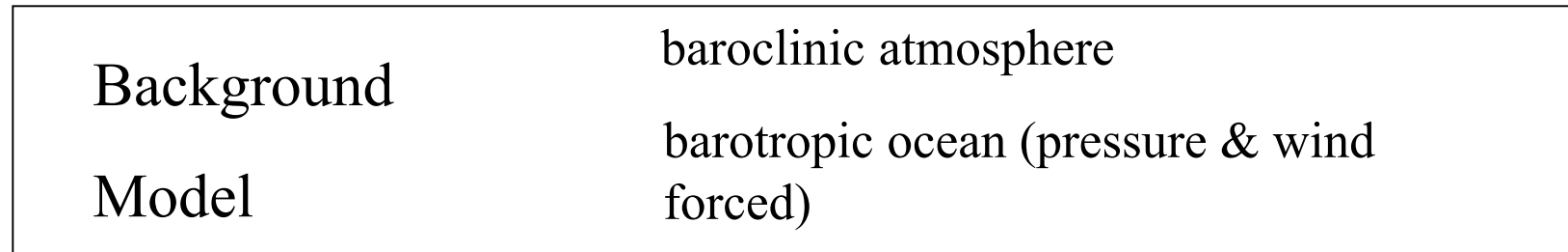

TARGET

Differences in monthly solutions are referenced to background model

- What is the error in changing to a different background model (remove-restore procedure), e.g. a different baroclinic atmosphere and a baroclinic ocean model ?
- How is the error between different models distributed spatially?

Uncertainty Analysis – Available Models

- Atmosphere
 - ECMWF 3D and 2D (T106)
 - NCEP Operational (3 & 6 hr) (operational, gridded 1x1)
 - NCEP Reanalysis
 - AOD1B (geoid only)
- Ocean
 - ECCO (constrained, no pressure forcing)
 - MITGCM
 - AOD1B (geoid only)

(ECCO + ECMWF) – AOD1B

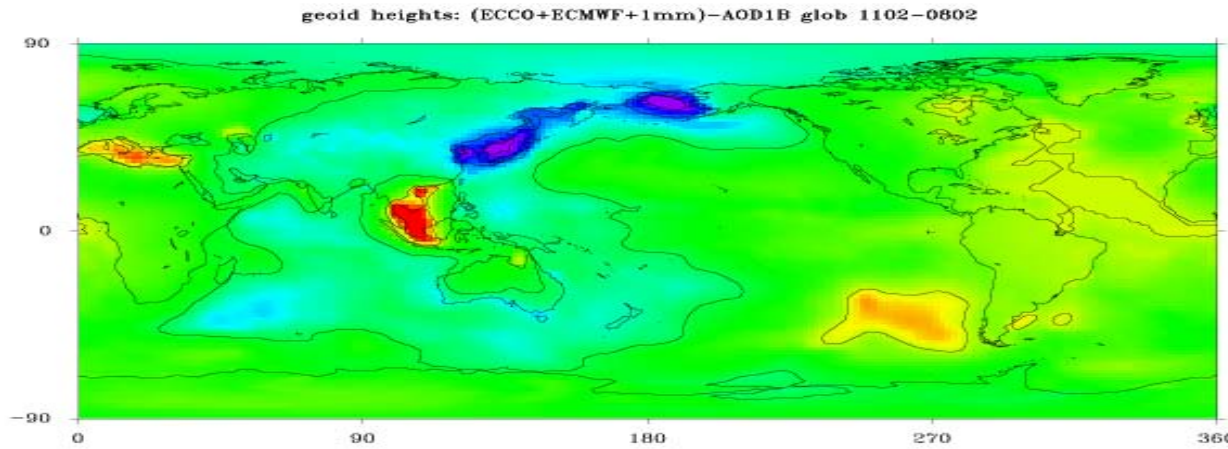

Comparison of the time evolution of different background models: 11/02-8/02.

Large differences appear over the ocean (except for Antarctica). Need to assess error and assign to component uncertainties.

(ECCO + NCEP) – AOD1B

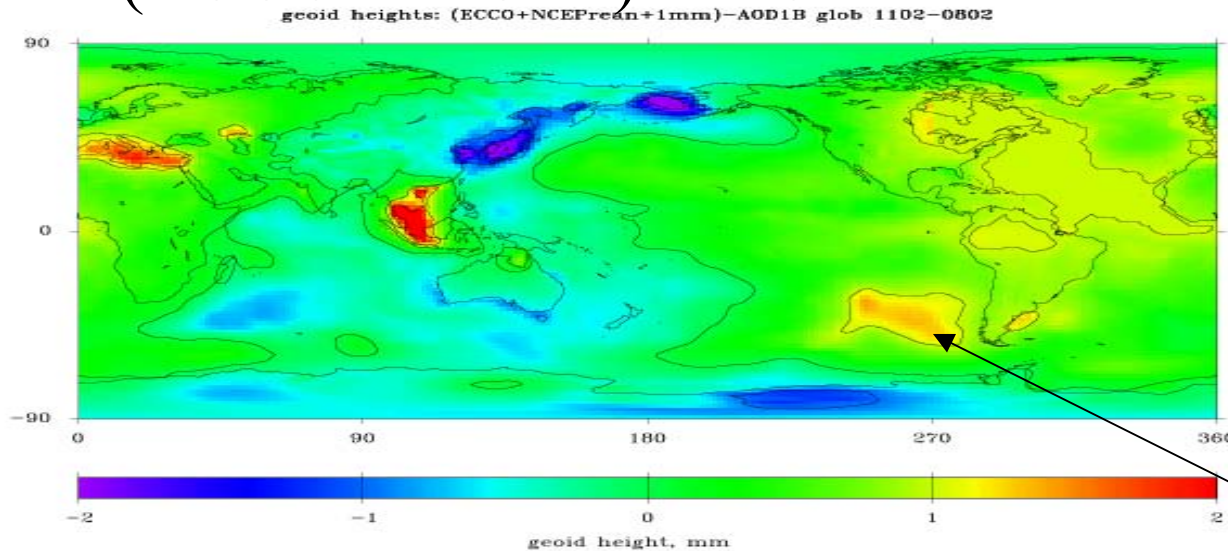

KEY

- ECCO: ocean model
- NCEP: atmos. model
- ECMWF: atmos. model

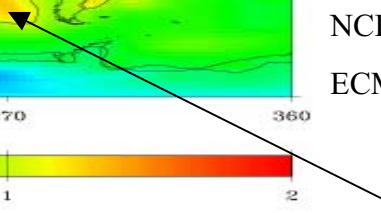

Region of high bottom pressure variability

rms NCEP oper 3D – AOD1B (atmos)

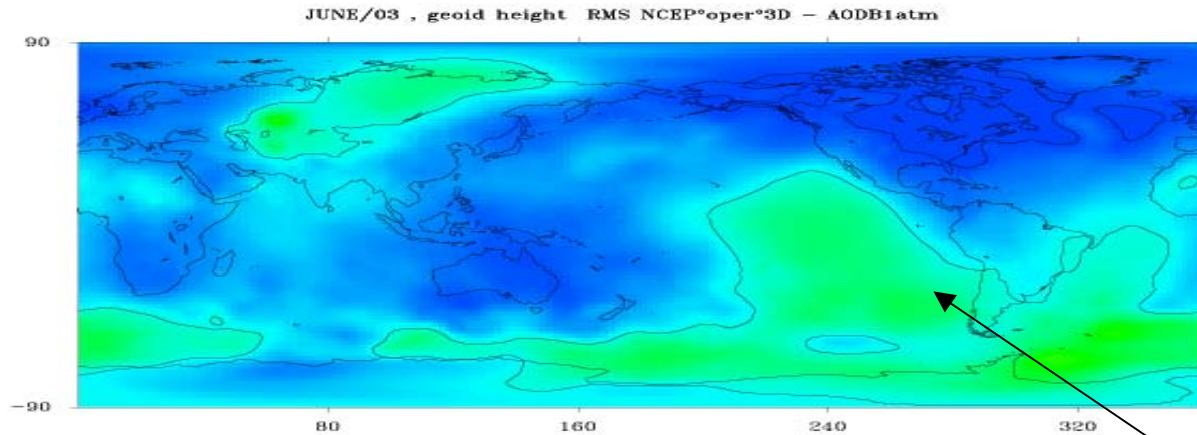

Largest differences appear to be introduced over oceans except for Antarctica and part of Siberia.

rms NCEP rean. 2D – AOD1B (atmos)

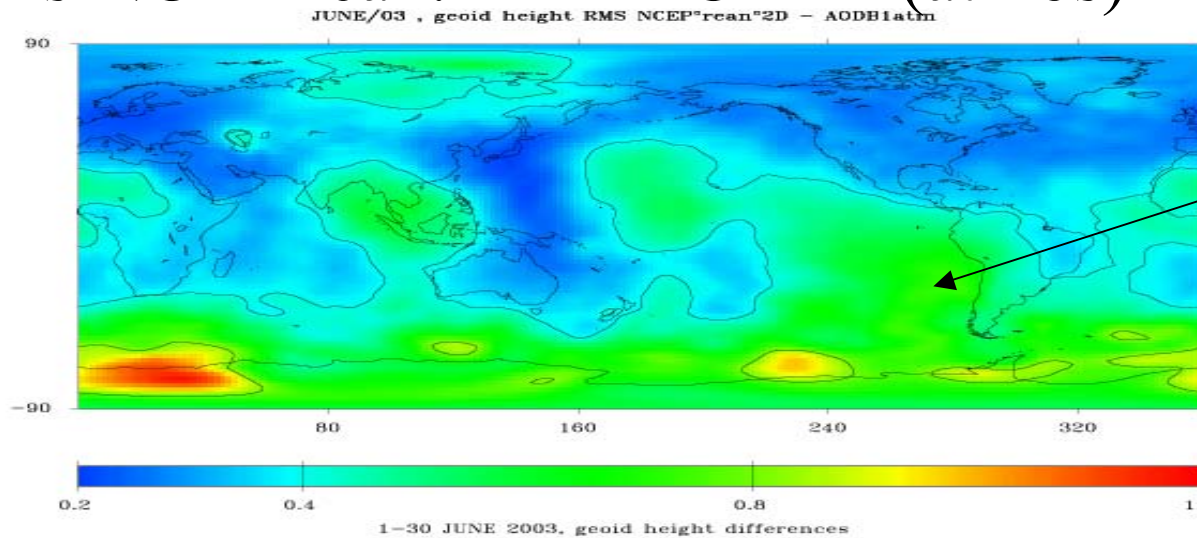

Note for later comparison to observed geoid differences.

Geoid variability (mm) at annual period derived from ECCO model (see Condi and Wunsch, JGR, in press)

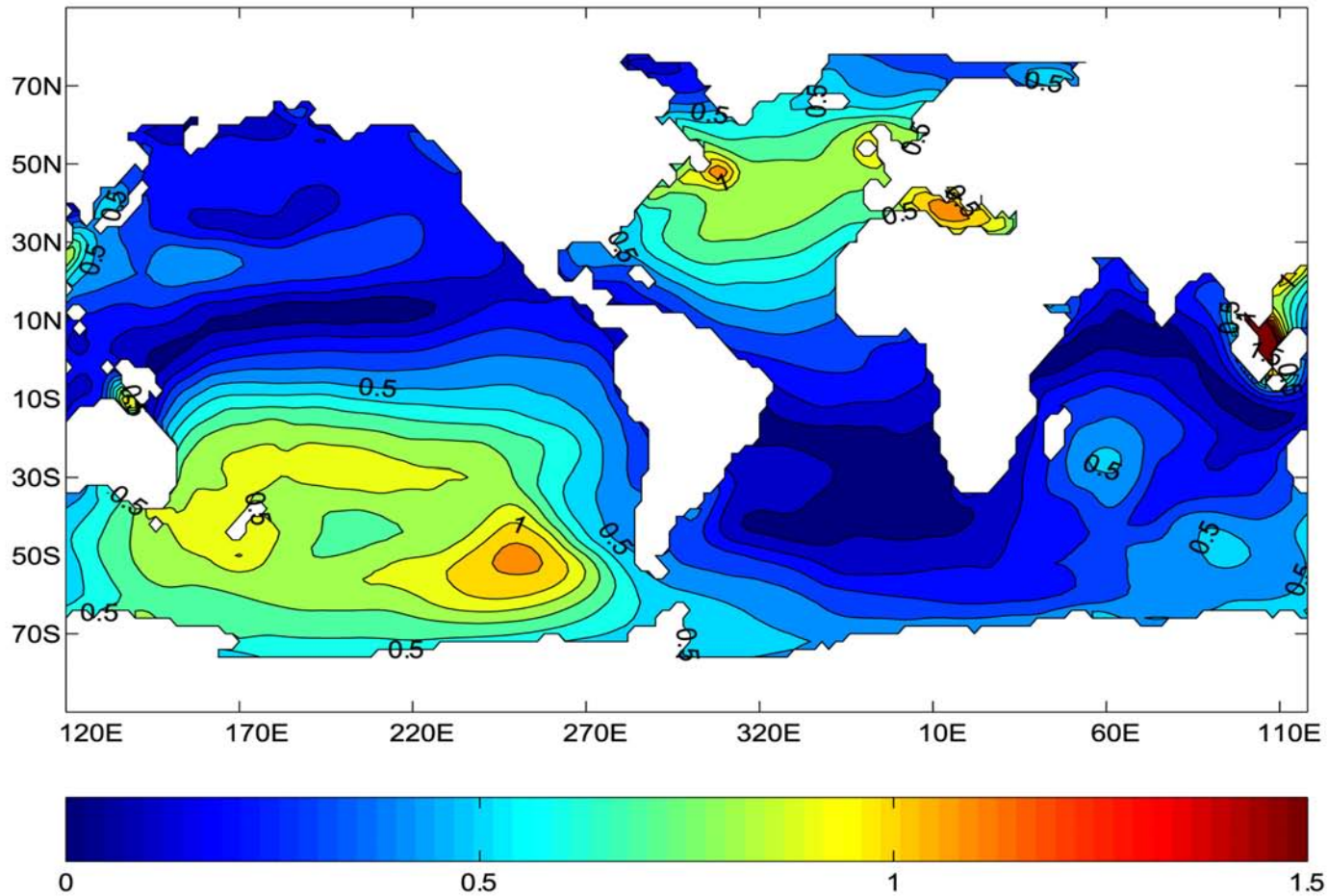

ECMWF 3D (vi) - 2D (ps) (1 day)

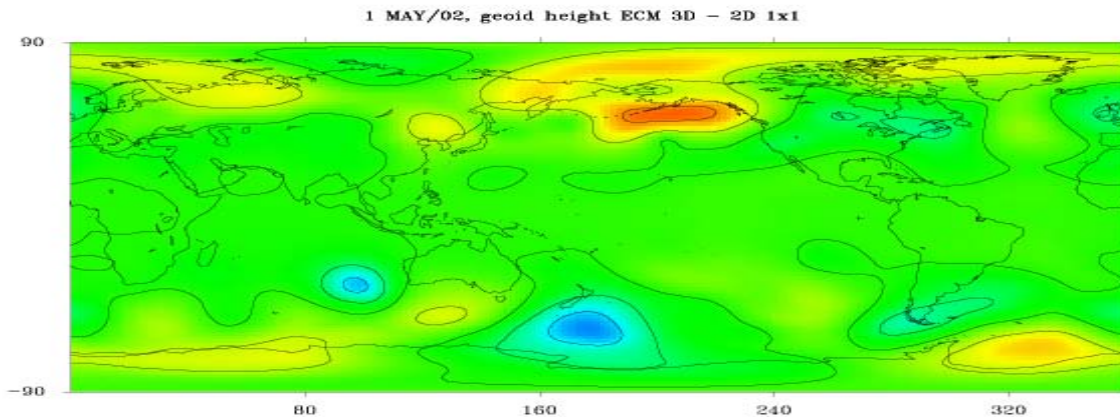

ECMWF 3D (vi) - 2D (ps) (monthly mean)

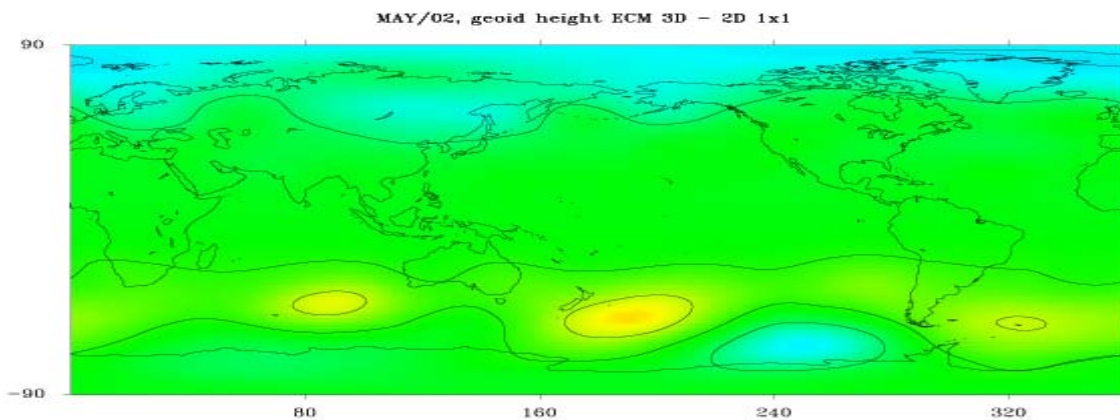

Monthly mean differences do not exceed 0.2 mm. Daily value magnitudes can be larger (e.g. cyclones & hurricanes). Results are similar for NCEP.

Nov – Aug '02

Geopotential Model Difference:
Time variable baroclinic atmos. and
barotropic ocean removed.

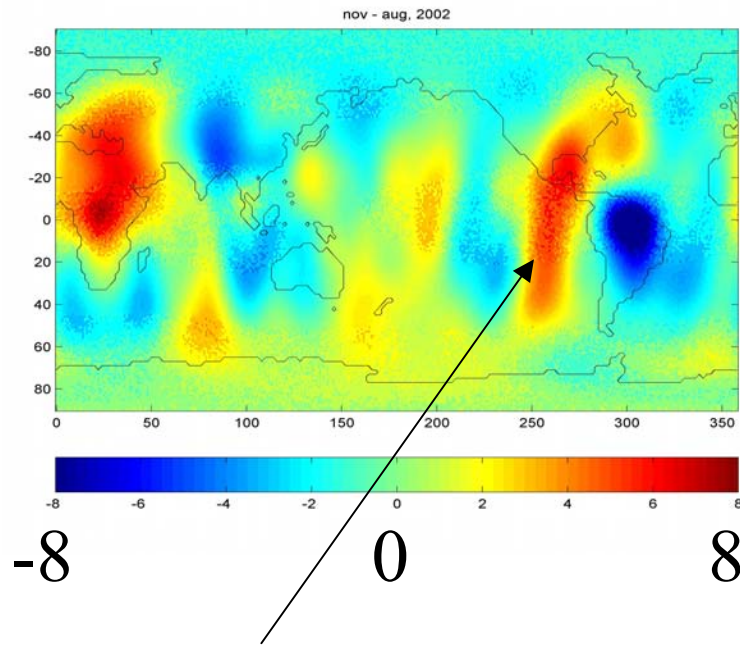

Note for previous comparison
to observed geoid differences.

ECMWF + ECCO (IB assumed)

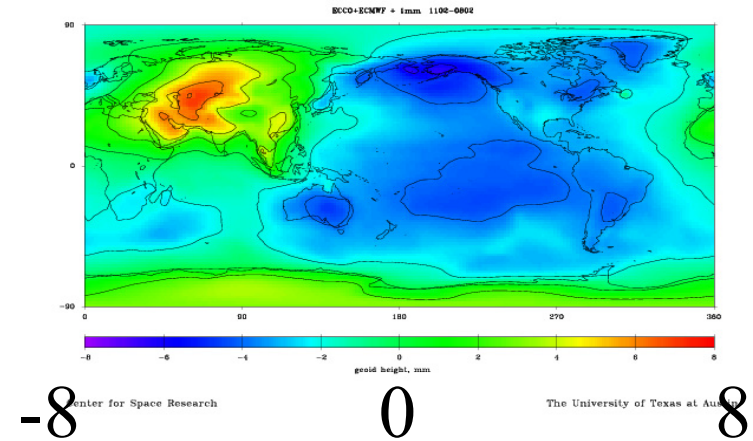

ECCO

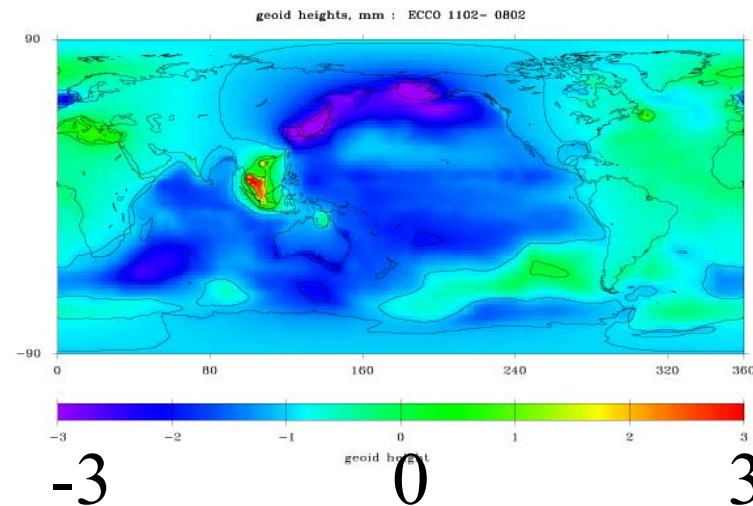

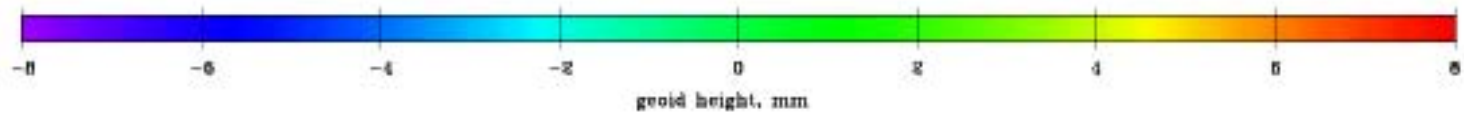
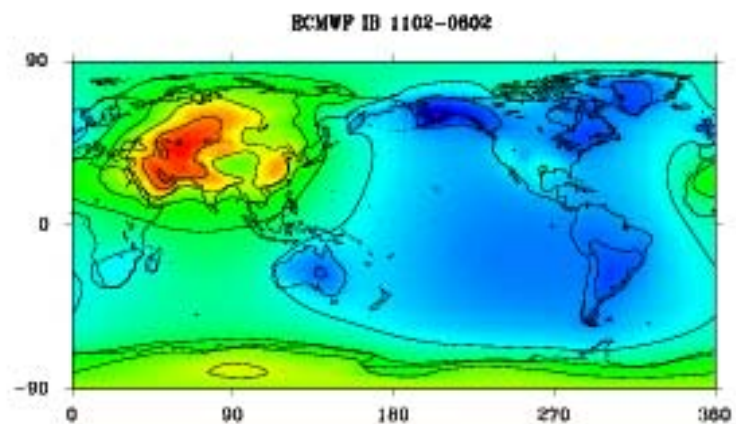
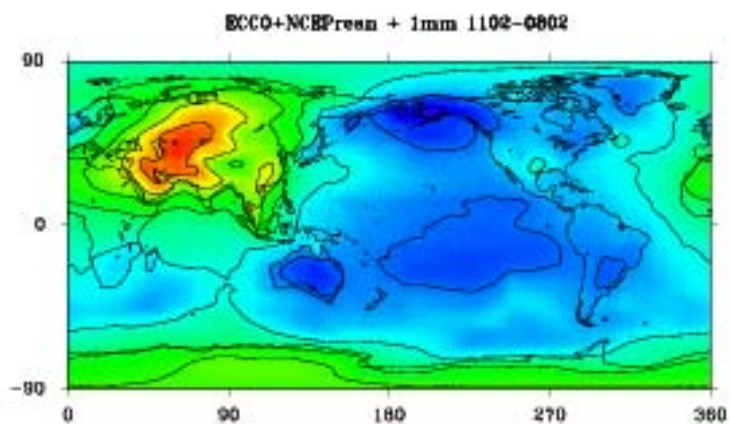
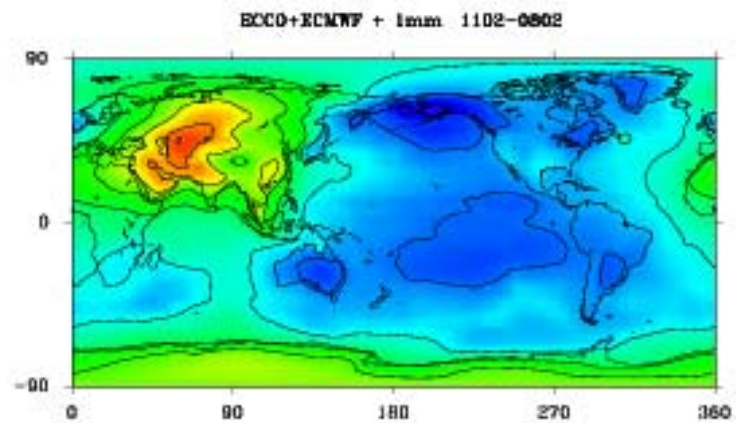
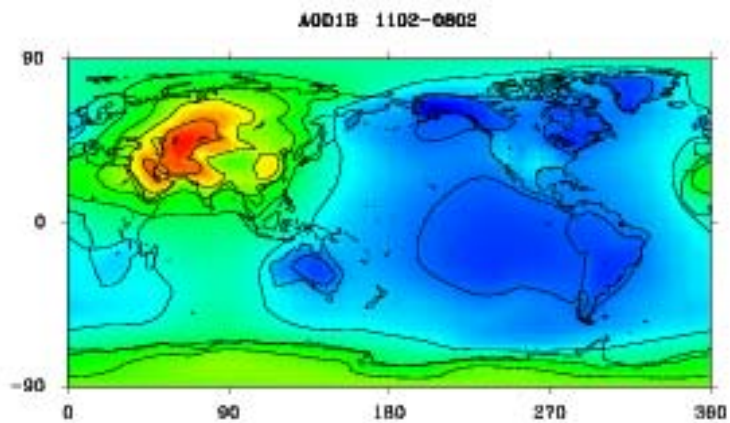

Geoid Height (mm) 3D-2D

Single Day Difference

May 1 '02

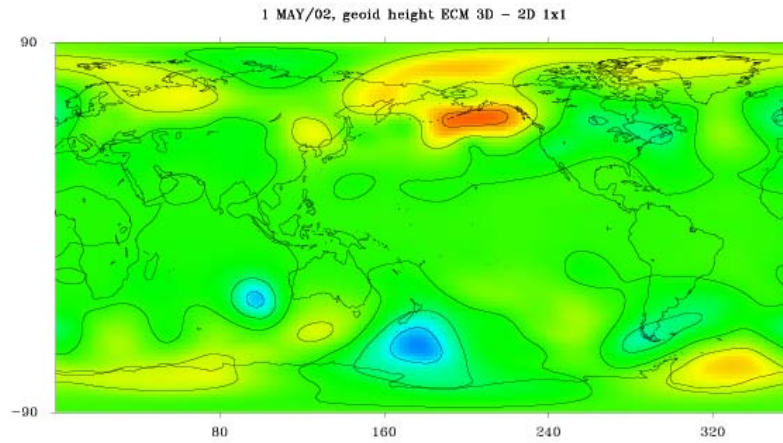

Monthly Difference

May '02

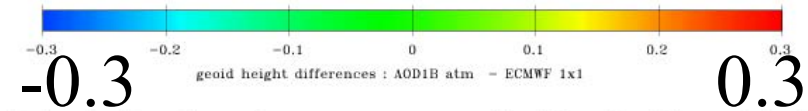
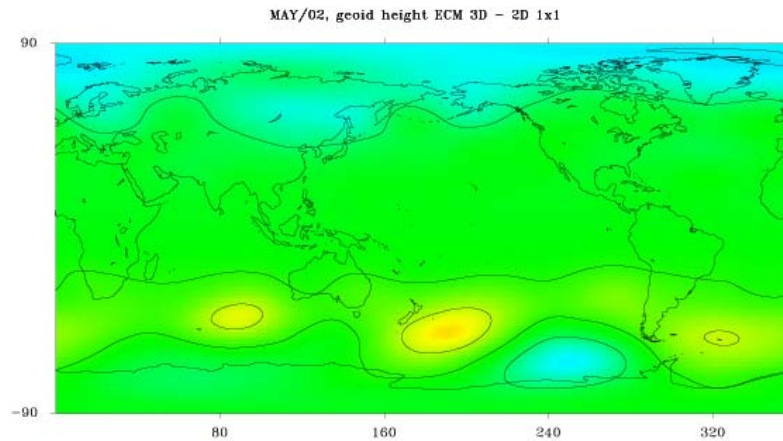

Center for Space Research

The University of Texas at Austin

Nov – Aug '02

Geopotential Model Difference:
Time variable baroclinic atmos. and
barotropic ocean removed.

ECMWF + ECCO (IB assumed)

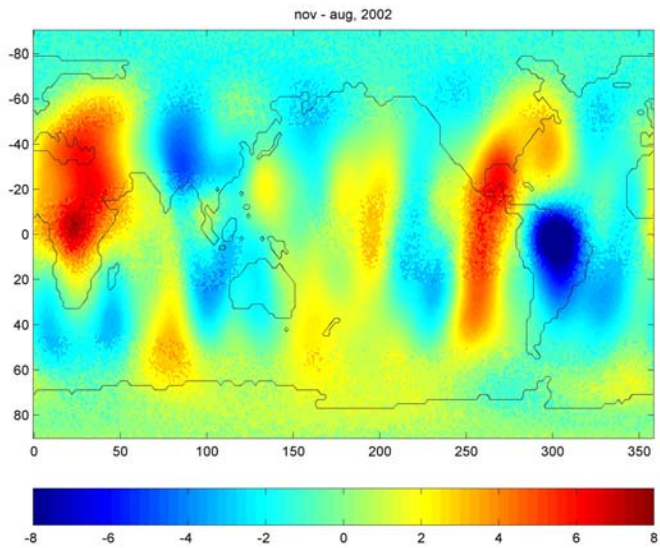

-8 0 8

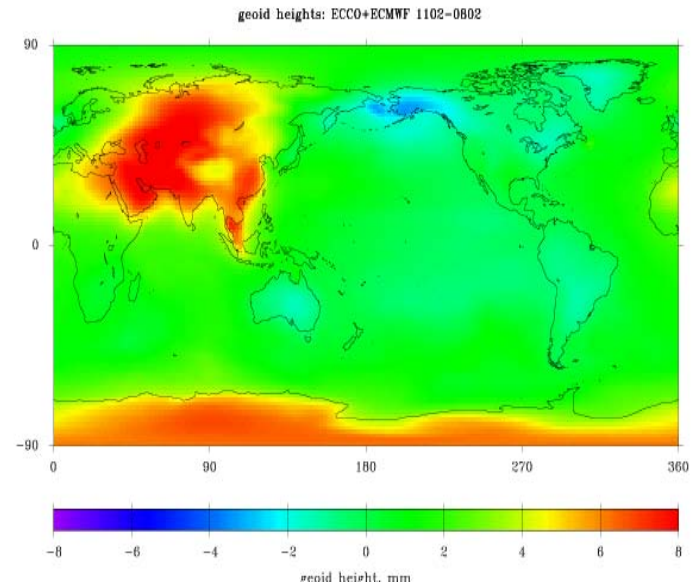

-8 0 8

ECCO Geoid Height: Nov – Aug '02

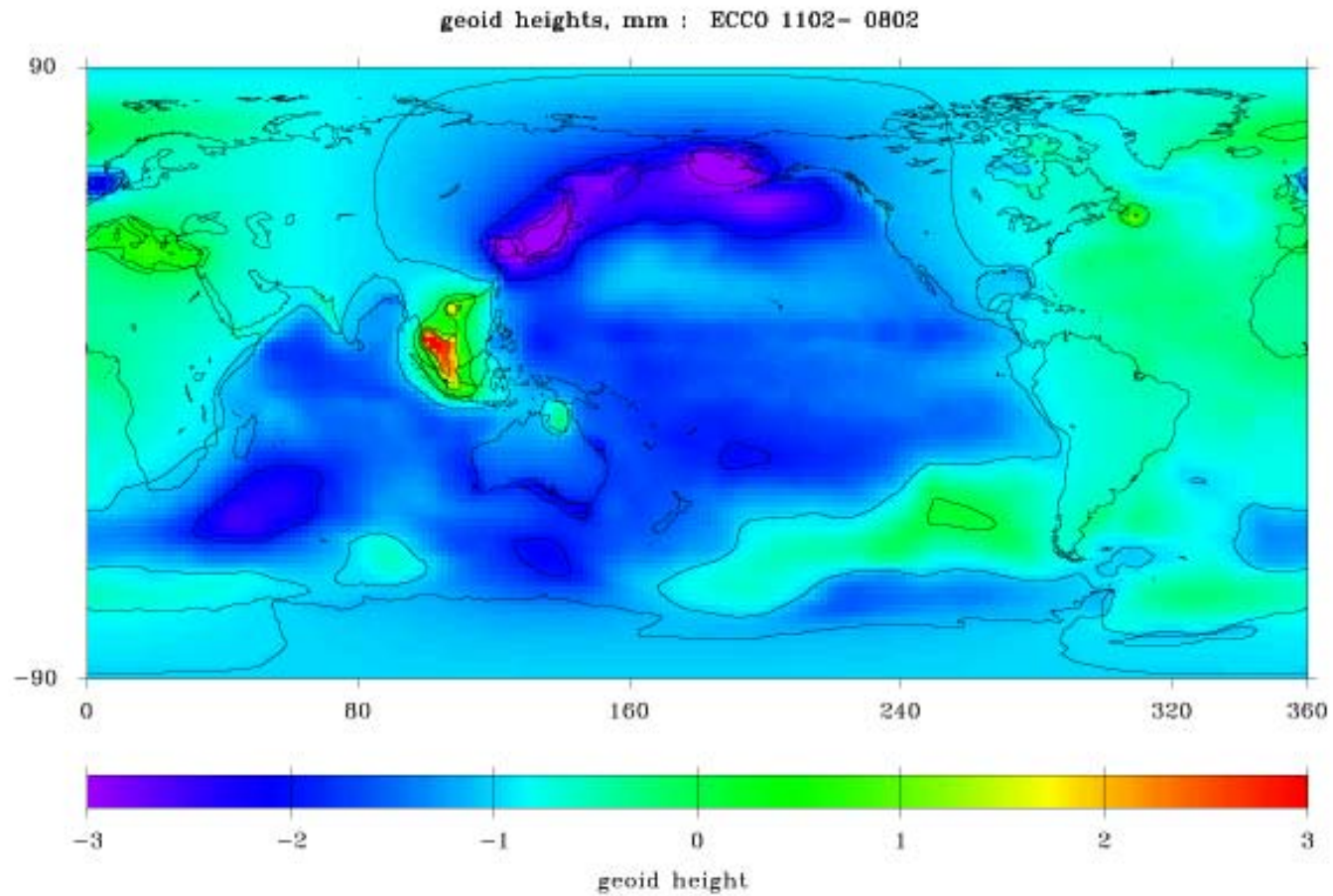

Atmospheric mass and motion signals in GRACE and Earth rotation measurements

David A. Salstein

Atmospheric and Environmental Research, Inc.
Lexington, MA 02421 USA

GRACE Science Team Meeting

Center for Space Research, U. Texas
Austin, Texas, USA

October 2003



Outline of investigation

Calculation of atmospheric surface pressure harmonics from atmospheric analysis systems

- NCEP-NCAR reanalyses: 1948 -
- NASA GEOS analyses: 1979-1995; new experiments
- ECMWF reanalysis, now 1957-Aug. 2002
- Analyze various operational analyses
- Include wet vs. dry components

- Estimation of the quality of atmospheric surface pressure; mass and angular momentum fields
 - Compare various data sets amongst themselves and with independent, station, data
 - Note any characteristic differences, including ocean, land, and high-topography land regions
 - Address sampling issues: including high frequencies (tides) and alias issues related to GRACE
 - Examine differences in angular momentum related to angular momentum/Earth rotation

- Relationship between atmospheric mass and Earth gravity harmonics

Coordinate with other GRACE scientists to:

- Compare atmospheric mass field harmonics from GRACE
- Note signals and residuals on climate time scales

Make available harmonics from various sets - following our “Special Bureau for the Atmosphere” functions

Surface Pressure Harmonics Jan.-Dec. 2001

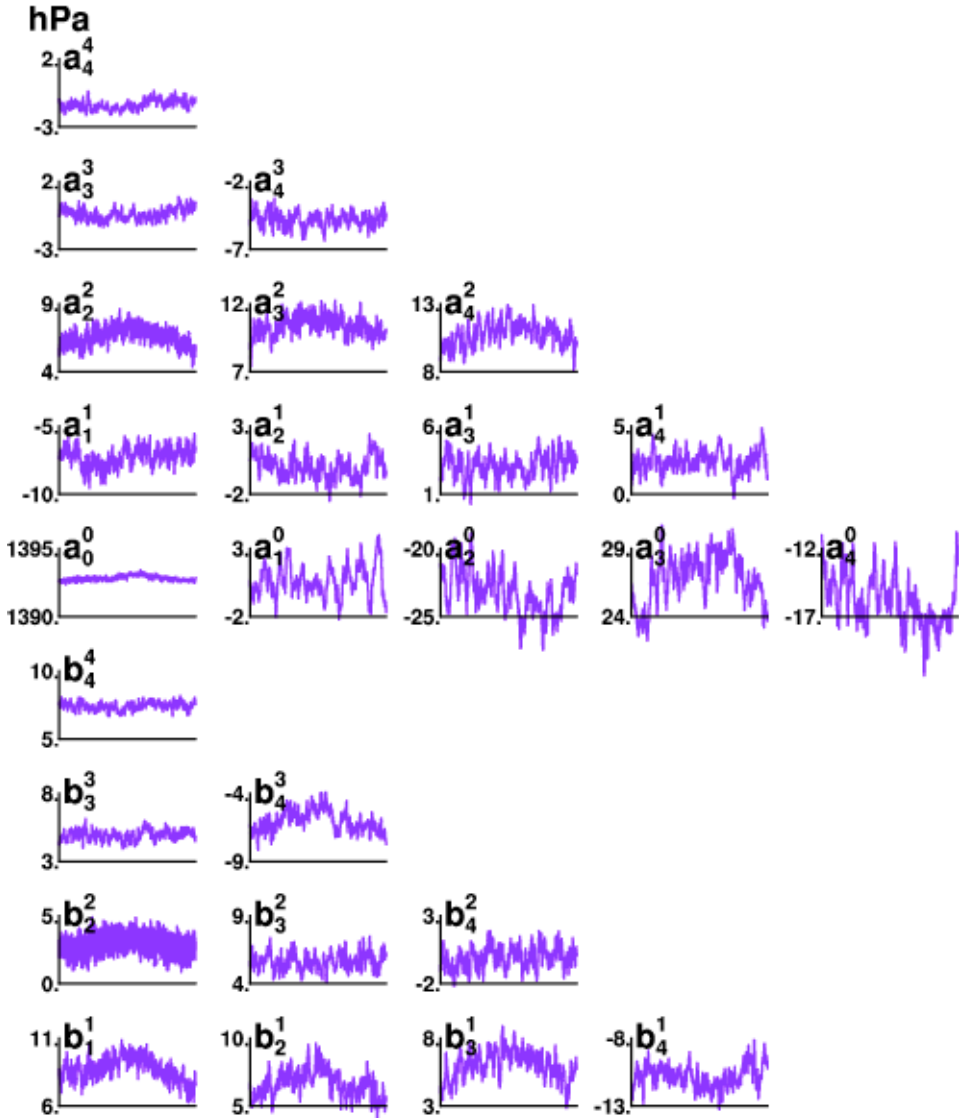

NCEP-NCAR
Reanalyses

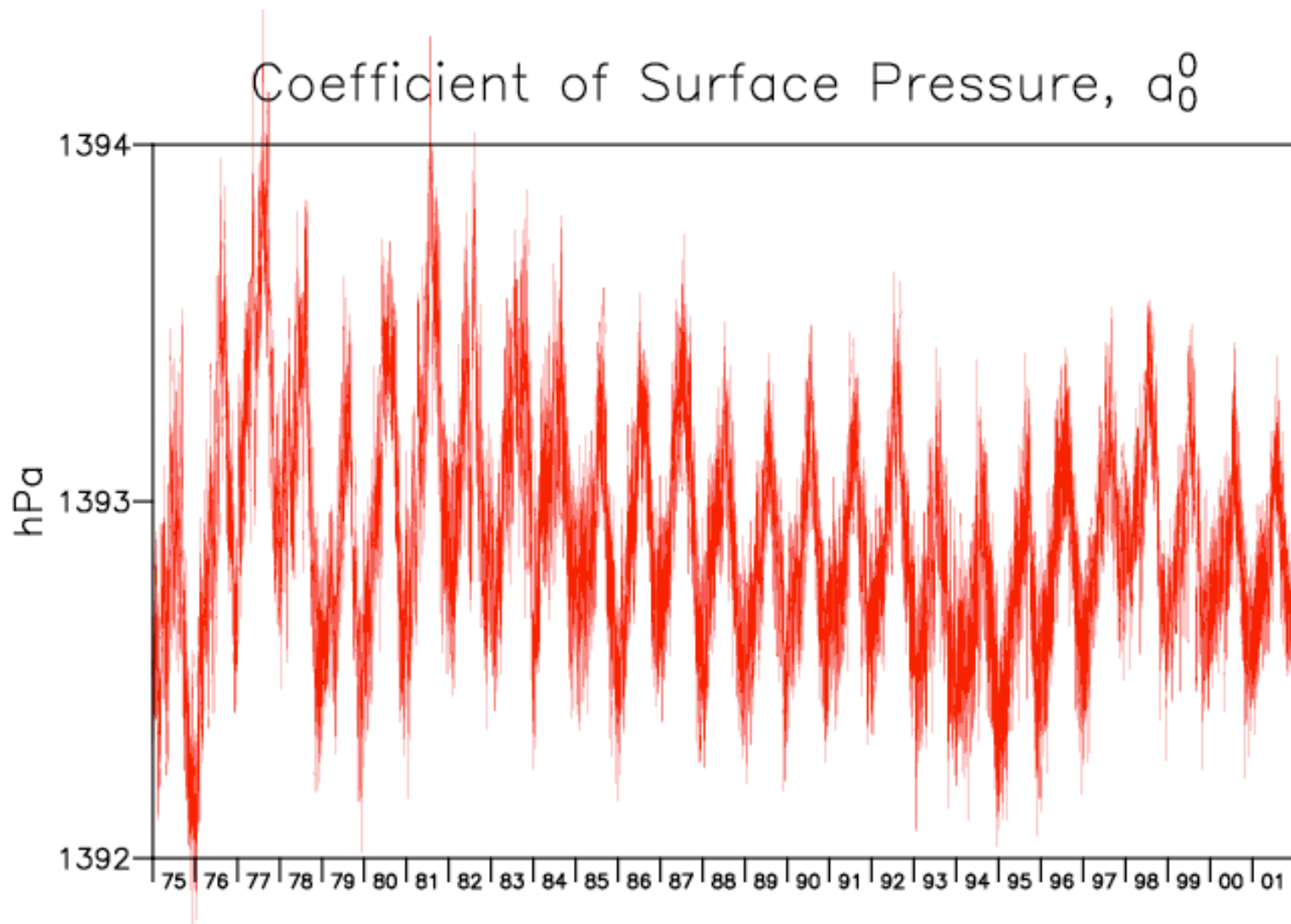

NCEP-NCAR Reanalyses

Atmospheric Surface Pressure to Different Spectral Resolutions (triangular)

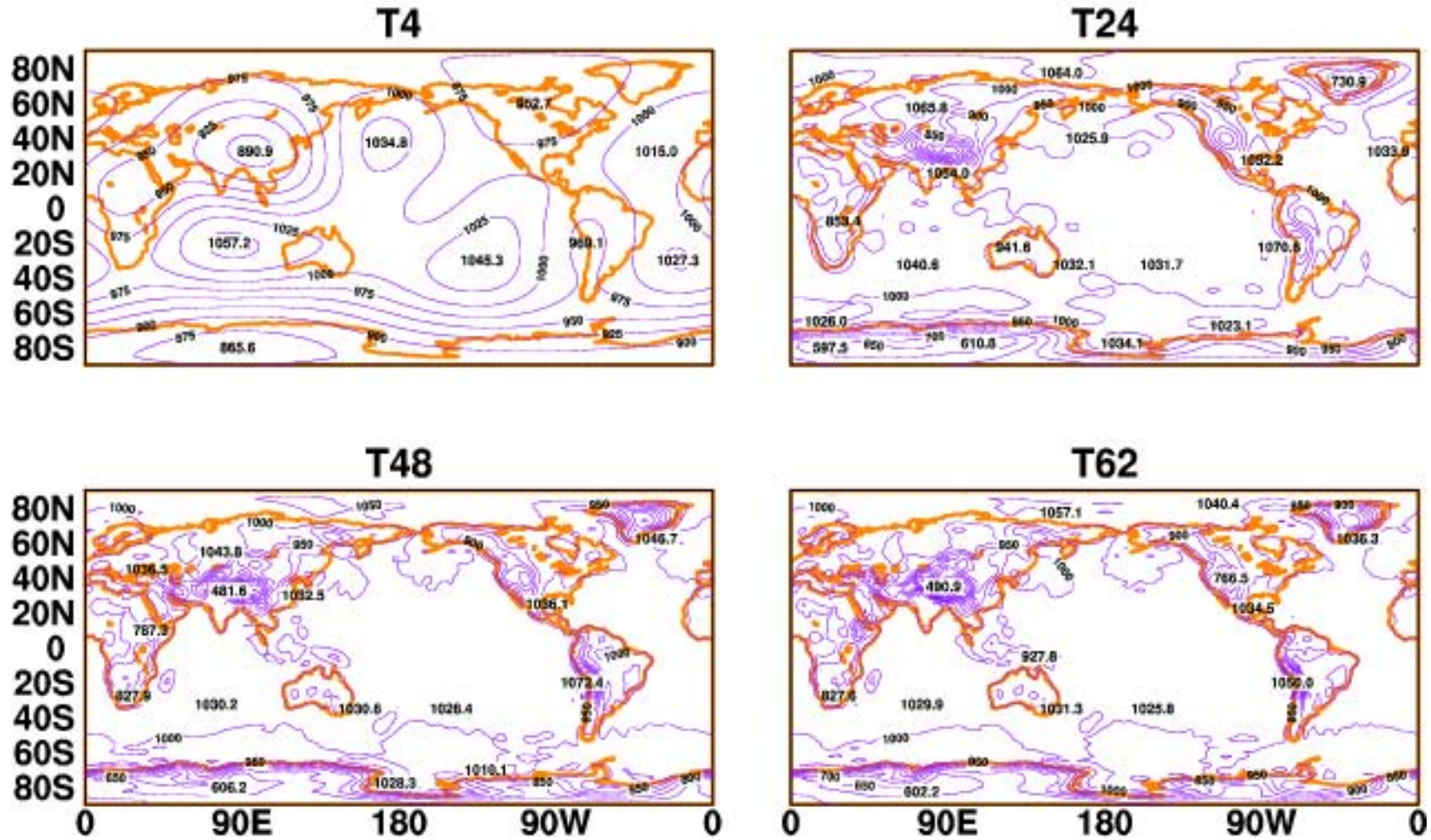

NCEP-NCAR Reanalyses

Earlier results: NCEP-NCAR and NASA GEOS-1 DAS P analyses

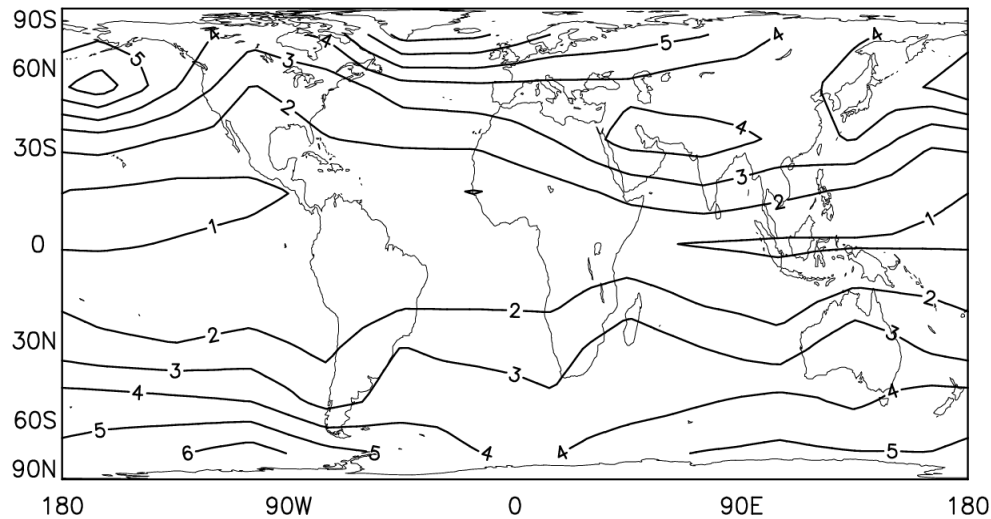

- Standard deviation of pressure from NCEP-NCAR reanalysis (hPa)

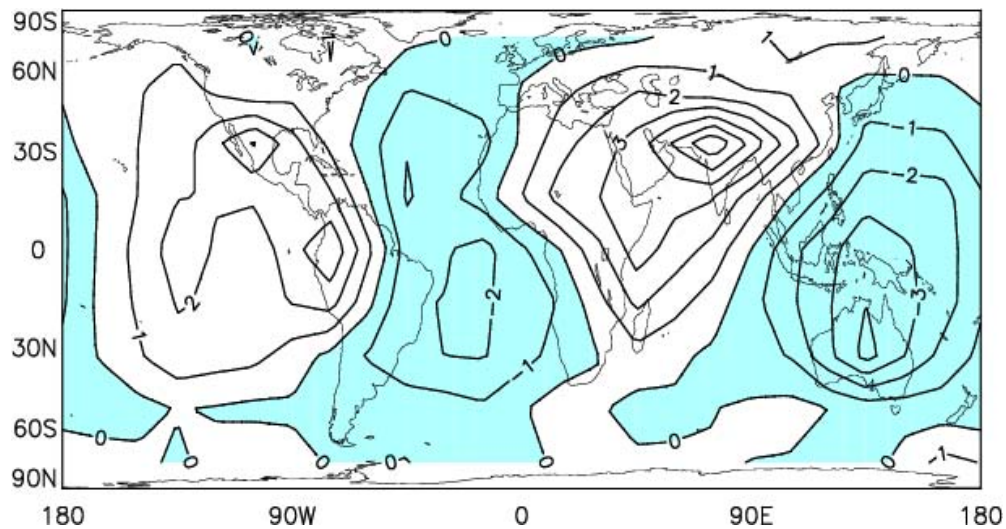

- Difference from NASA GEOS-1 DAS for one month

Reanalysis Earth rotation excitation
(2002)

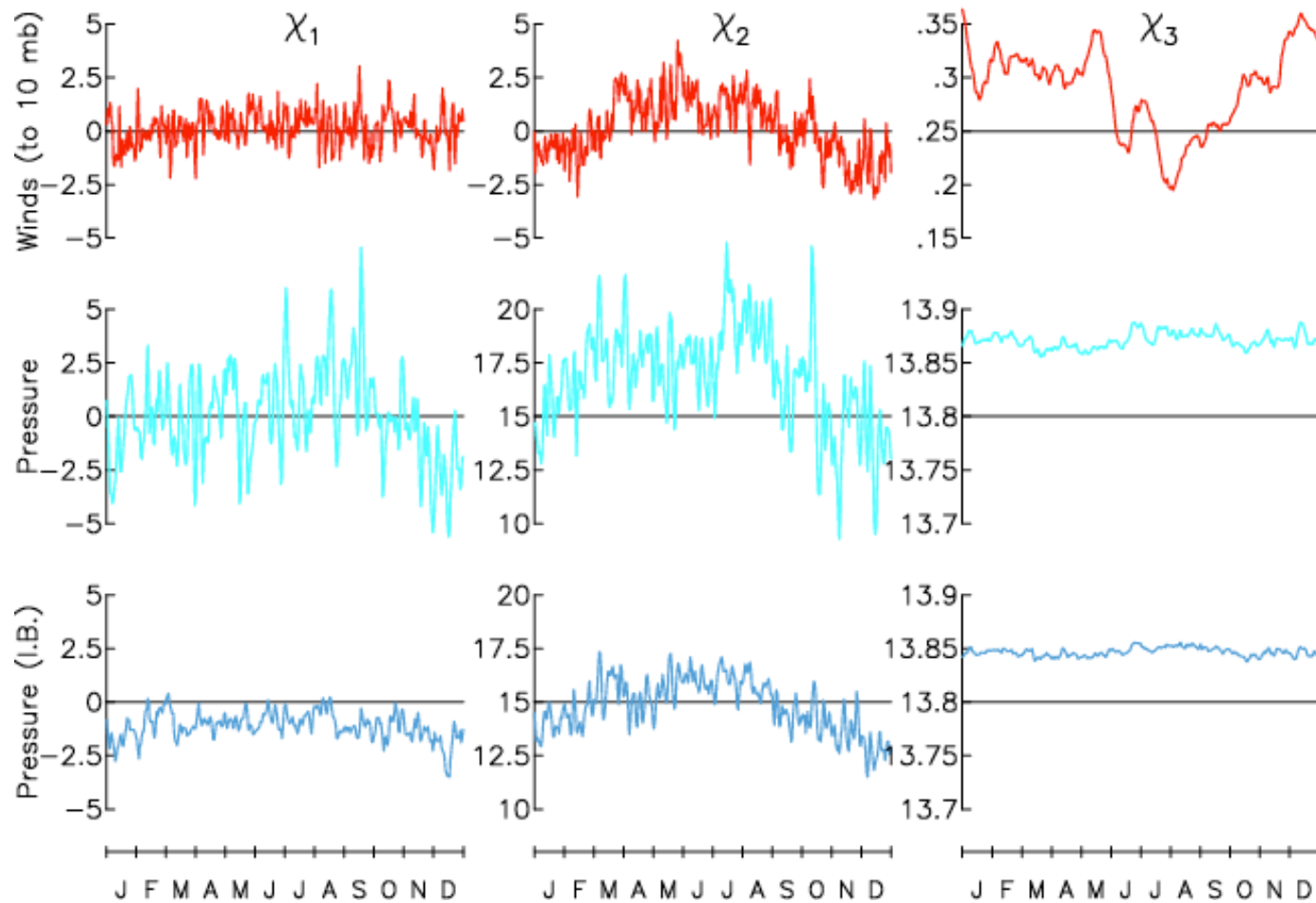

Polar motion

Length-of-day

NCEP Reanalysis Power Spectra, 1958–2002

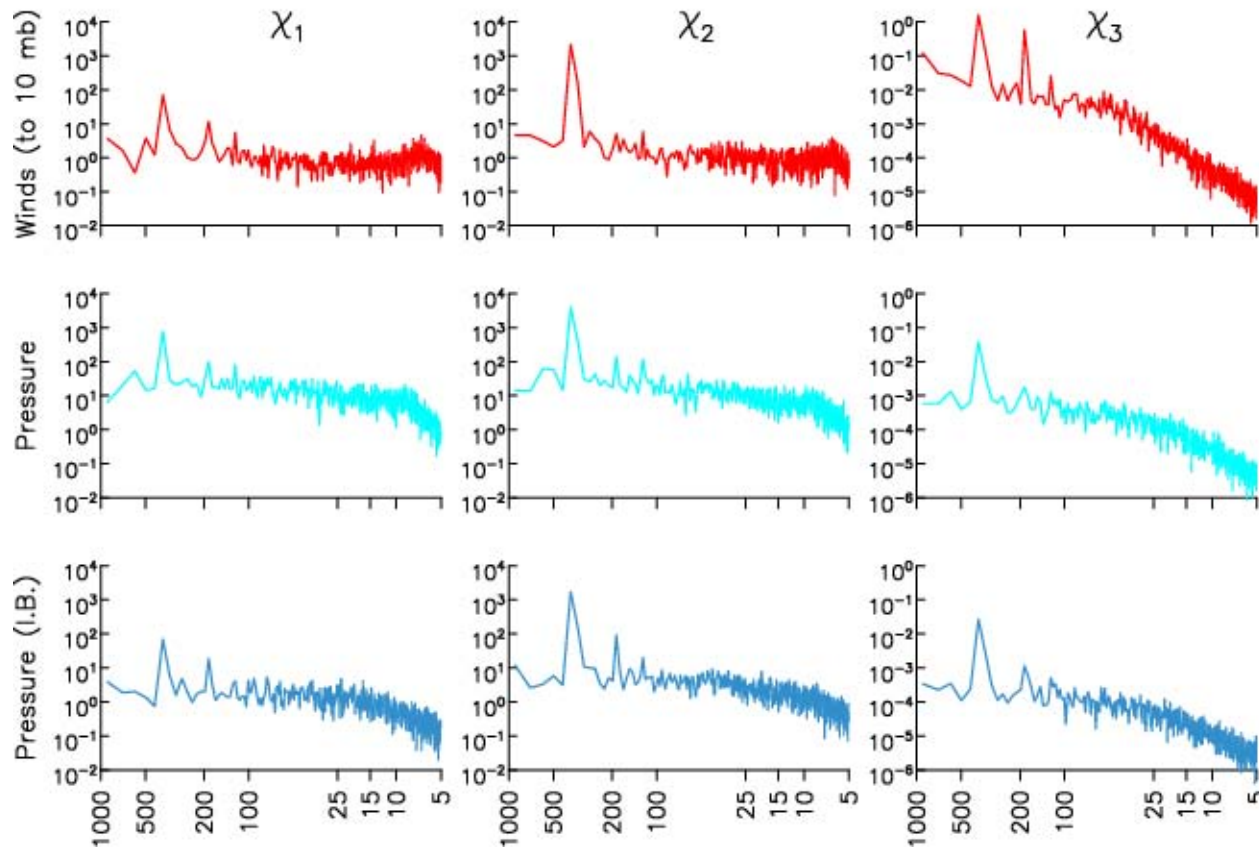

<-- Higher frequencies

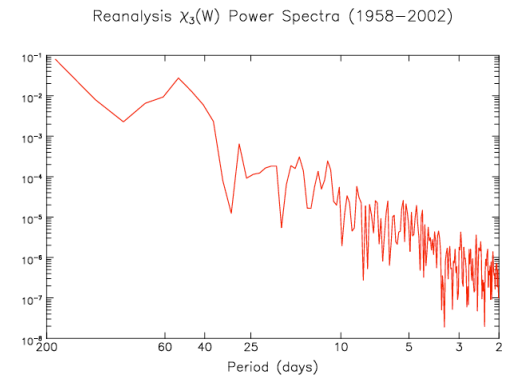

Difference between NCEP Reanalysis and Operational excitations of Earth rotation/Polar motion”

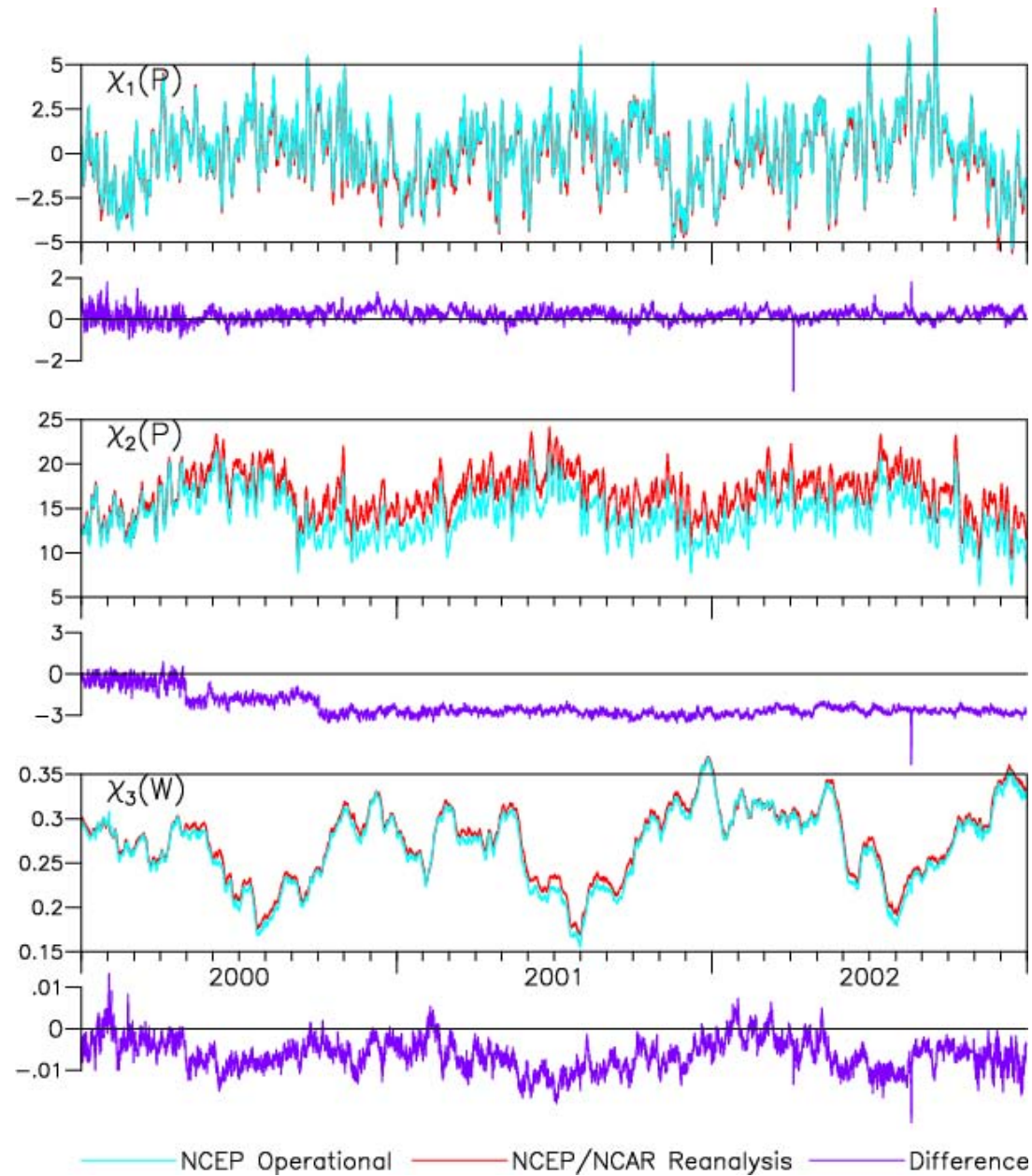

Sea-level pressure: RMS difference between station observations and NCEP Operational analysis

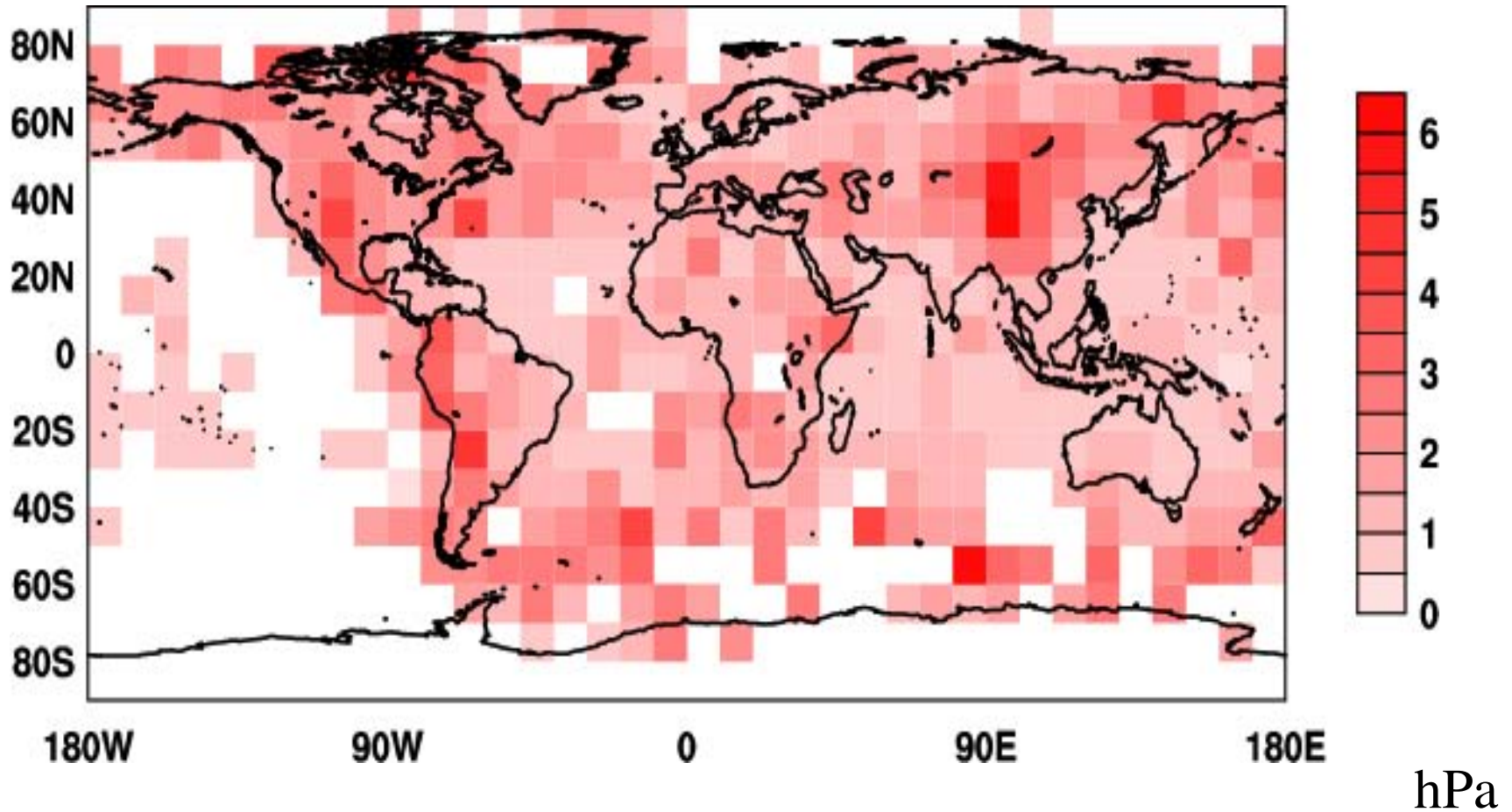

Summary

- Calculate atmospheric mass fields and harmonics from surface pressure analyses
 - Supply to GRACE project and intercompare with GRACE results
 - Examine climate signatures
 - Estimate quality of atmospheric mass signal
 - Use other atmospheric geodynamic signals from Earth rotation/polar motion to aid in study
-
- PI (D. Salstein) also has project of N. American water balance: GEWEX/GAPP/NAME -- interest in involving GRACE

Constraints on Melting, Sea Level and the Paleoclimate from GRACE

PI: Jim Davis

Smithsonian Astrophysical
Observatory

Co-I: Jerry Mitrovica

University of Toronto

Project Goals

- Use GRACE to constrain present-day melting (secular and seasonal) from the Earth's major ice complexes
- Investigate contributions (melting vs. steric) to present-day sea-level change
- Constrain scenarios for melting in Late Pleistocene and Holocene

Interrelatedness between Ice Load Changes, Earth Response, and Sea Level

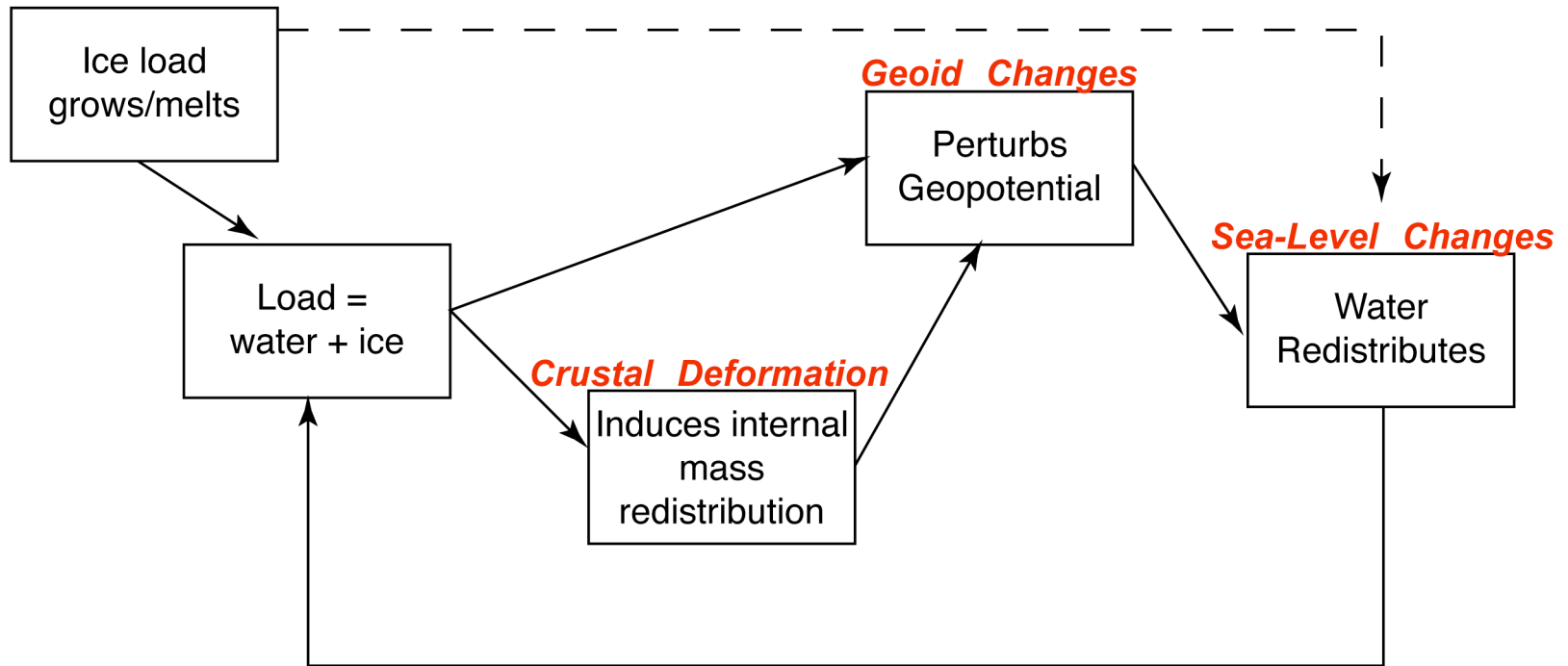

Geoid “fingerprints”
[*Mitrovica et al., 2001*] for
uniform melting from
(A) Antarctica,
(B) Greenland, and
(C) mountain glaciers

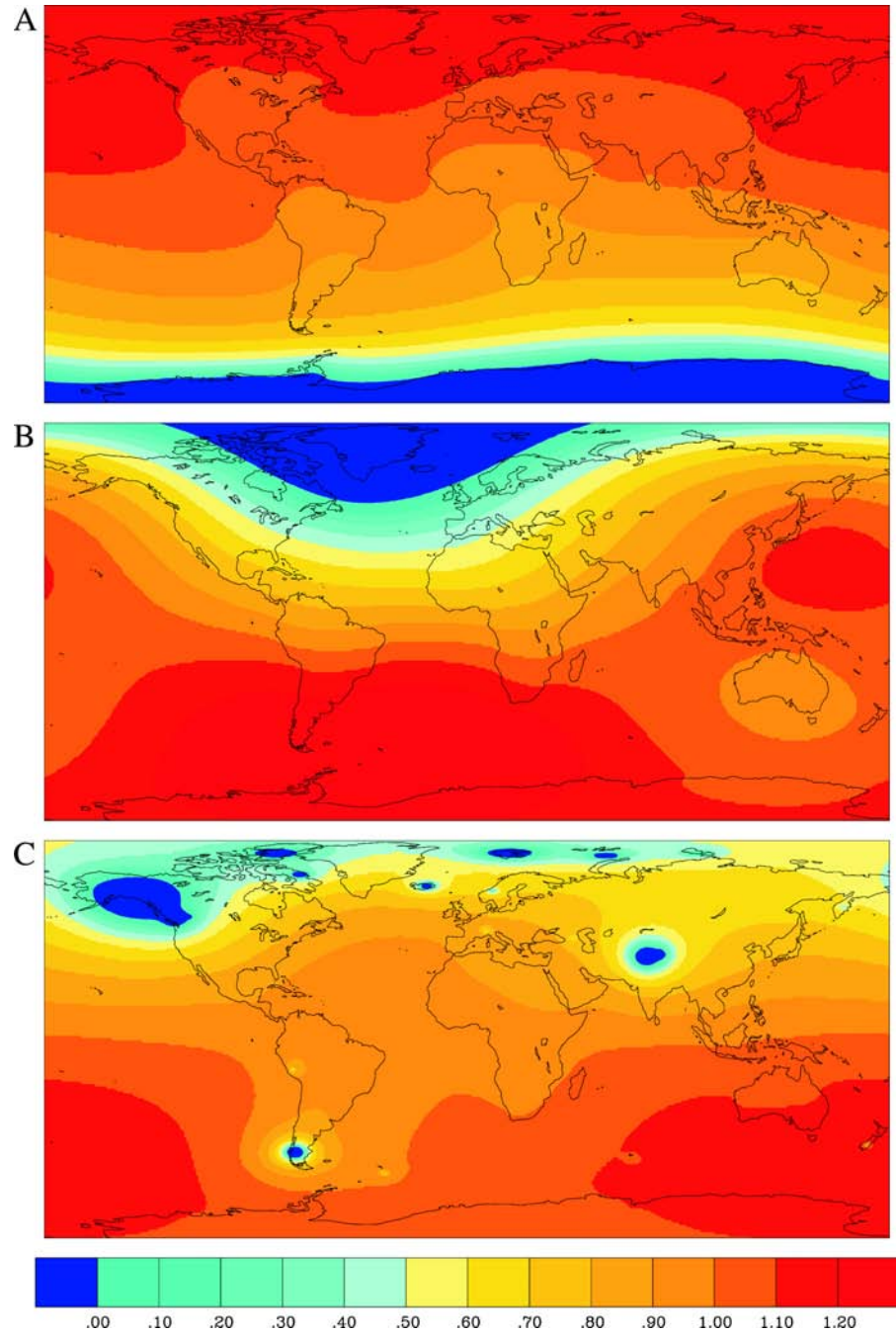

Present-Day Melting: Approach

- Calculate fingerprints calculated with realistic melting scenarios
- Fit GIA-corrected GRACE data to fingerprint model, estimating amplitudes of melting
- Incorporation of additional data sets (tide-gauge, geodetic, ocean temperature) will contribute to internal consistency of modeled ice-ocean-Earth response to melting

Contributed Resources

- Presently designing web site for calculation of solid Earth deformation, geoid and sea-level variations for suite of two-layer viscosity models for GIA correction
- Will make calculation of fingerprints for present-day melting available also

Hydrological And Oceanographic Applications of GRACE

John Wahr, Isabella Velicogna, Sean Swenson

University of Colorado

Steve Jayne

Woods Hole Oceanographic Institution

Our general intent: use the GRACE time-variable gravity fields to construct estimates of mass variability at the Earth's surface. Apply those estimates to hydrological and oceanographic problems.

Finding the change in surface mass averaged over specific regions

Let $\sigma(\theta,\phi)$ be the surface mass density at (θ,ϕ) . Construct

$$\bar{\sigma} = \int \sigma(\theta,\phi) W(\theta,\phi) \sin\theta d\theta d\phi$$

where $W(\theta,\phi)$ is an averaging function for the region.

Equivalent to:

$$\bar{\sigma} = \frac{a \rho_{ave}}{3} \sum_{l,m} \frac{2l+1}{1+k_l} \left[W_{clm} C_{lm} + W_{slm} S_{lm} \right]$$

where

$$W(\theta,\phi) = \frac{1}{4\pi} \sum_{l,m} \tilde{P}_{lm}(\cos\theta) (W_{clm} \cos m\phi + W_{slm} \sin m\phi)$$

Larger averaging region and smoother averaging function = more accurate results.

An optimal averaging function is ≈ 1 inside the region and ≈ 0 outside, but is smoothed along the margins.

We have developed algorithms for finding optimal W 's for arbitrary regions [Swenson & Wahr, JGR-Solid Earth, Sept, 2002; Swenson, et al, Water Resources Research, Aug, 2003].

ENTIRE MISSISSIPPI RIVER BASIN

"Radius" (= sqrt (area/pi)) = 1109 km

Weighting Function

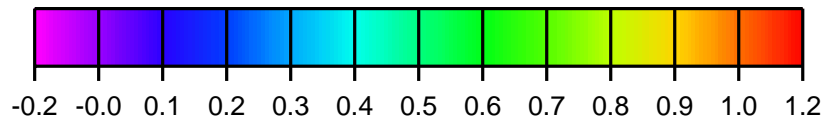
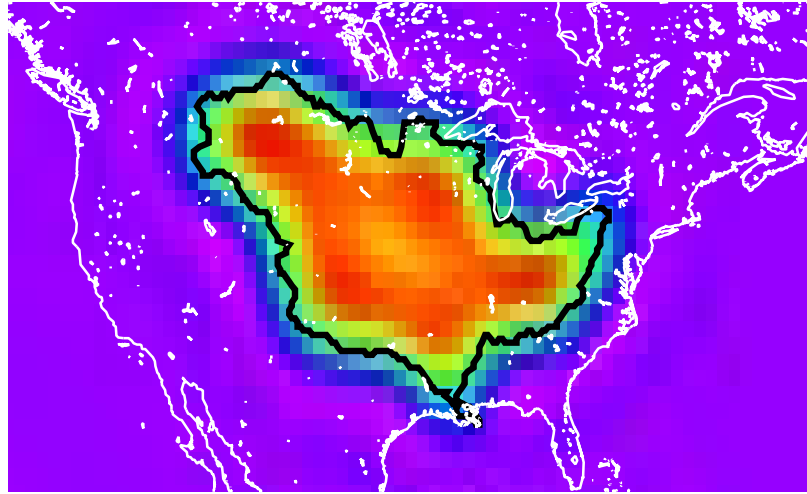

average water thickness (cm)

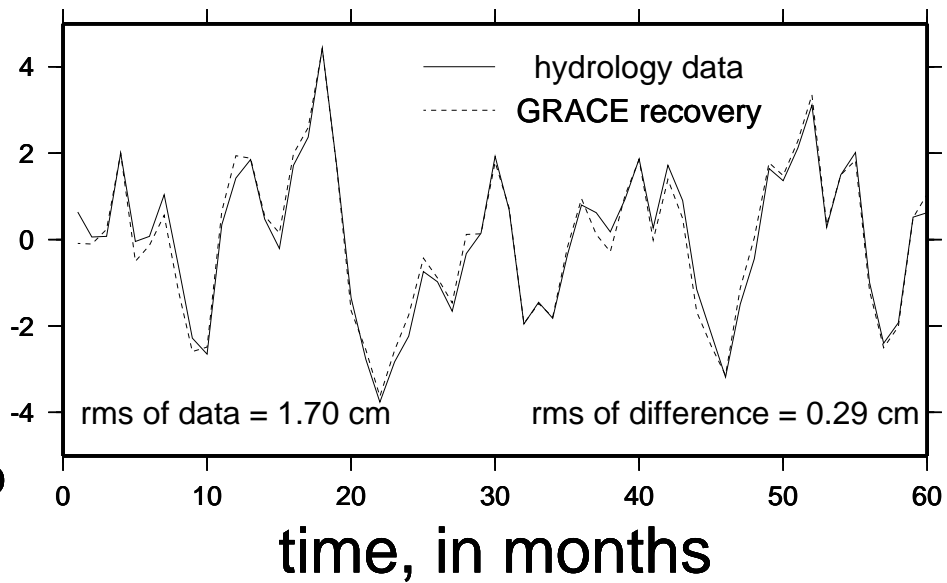

atmos press errors:	0.26 cm
GRACE measurement errors:	0.11 cm
leakage from water outside basin:	0.03 cm

TOTAL ERROR:	0.29 cm

Hydrology

- (1) Compare GRACE estimates with hydrology model output, to help assess the model.
- (2) Find average over a river basin; combine with river runoff measurements to estimate precip–minus–evap over that basin.
- (3) Look for specific signals in specific regions: aquifer depletion, changes in large mountain glacier systems, etc.

Oceanography

GRACE mass estimate is equivalent to bottom pressure

- (1) Compare GRACE estimate with ocean model output, to help assess the model.
- (1) Combine with altimetry sea surface height measurements to determine monthly changes in oceanic heat content.
- (2) Use the geostrophic assumption to estimate monthly changes in deep ocean currents.

Estimating precip–minus–evap averaged over river basins.

Method:

Use GRACE to estimate total change in water in the basin.

Use river discharge measurements to determine the runoff.

The difference = precipitation–minus–evapotranspiration.

Estimating Precipitation–Minus–Evapotranspiration (P–ET)
(All numbers are RMS about the mean)

(1) The Mississippi River basin:

GRACE monthly water storage error	0.30 cm
Runoff measurement error (10% of total river discharge)	0.15 cm

Resulting error in monthly P–ET	0.35 cm
Total monthly P–ET (Betts, et al, 99)	1.6 cm

(2) The Ohio River basin:

GRACE monthly water storage error	0.45 cm
Runoff measurement error (10% of total river discharge)	0.40 cm

Resulting error in monthly P–ET	0.60 cm
Total monthly P–ET (Betts, et al, 99)	3.5 cm

In both cases: RMS of GRACE P–ET errors ≈ 0.5 cm/month
 $\approx 20\%$ of total RMS.

Oceanic Heat Storage

Changes in sea surface height occur because of:

- (i) changes in the total mass of the water column.
- (ii) "steric" effects: the vertical expansion of the water column due to changes in temperature or salinity.

Use satellite altimeter measurements (Jason) to find changes in sea surface height.

Use GRACE to estimate changes in water mass.

The steric signal is the difference.

Ignore the expansion caused by changes in salinity.

Assume the thermal expansion coefficient is independent of depth.

The heat storage change is then proportional to the steric signal.



Global hydrological modeling of the terrestrial water storage & first hydrological signal indications from GRACE

**Güntner A., Flechtner F., Reigber Ch., Schmidt R.
GFZ Potsdam, Germany**

**Döll P.
University of Kassel, Germany**



WGHM global modeling of the terrestrial water storage



WaterGAP Global Hydrology Model (WGHM) (Döll et al., 2003)

- **Dynamic simulation of hydrological processes and water storages at the global scale**
- **Water storage compartments taken into account in the model:**
 - **groundwater storage**
 - **root-zone soil water**
 - **snow storage**
 - **storage in rivers, lakes and wetlands**

Döll, P., Kaspar, F., Lehner, B. (2003): A global hydrological model for deriving water availability indicators: model tuning and validation. *Journal of Hydrology*, 270, 105-134.



WGHM global modeling of the terrestrial water storage



WGHM - general model characteristics

- **Spatial resolution: 0.5° (all land masses except Antarctica)**
- **Computational time step: 1 day**
- **Model forcing with climate data from CRU, ECMWF, GPCC**
- **Model tuning and validation against measured river discharge at 724 stations world-wide (covering 70% of actively draining global land area)**

WGHM global modeling of the terrestrial water storage

Example of results: Seasonal storage change (mm), mean of period 1961-1995

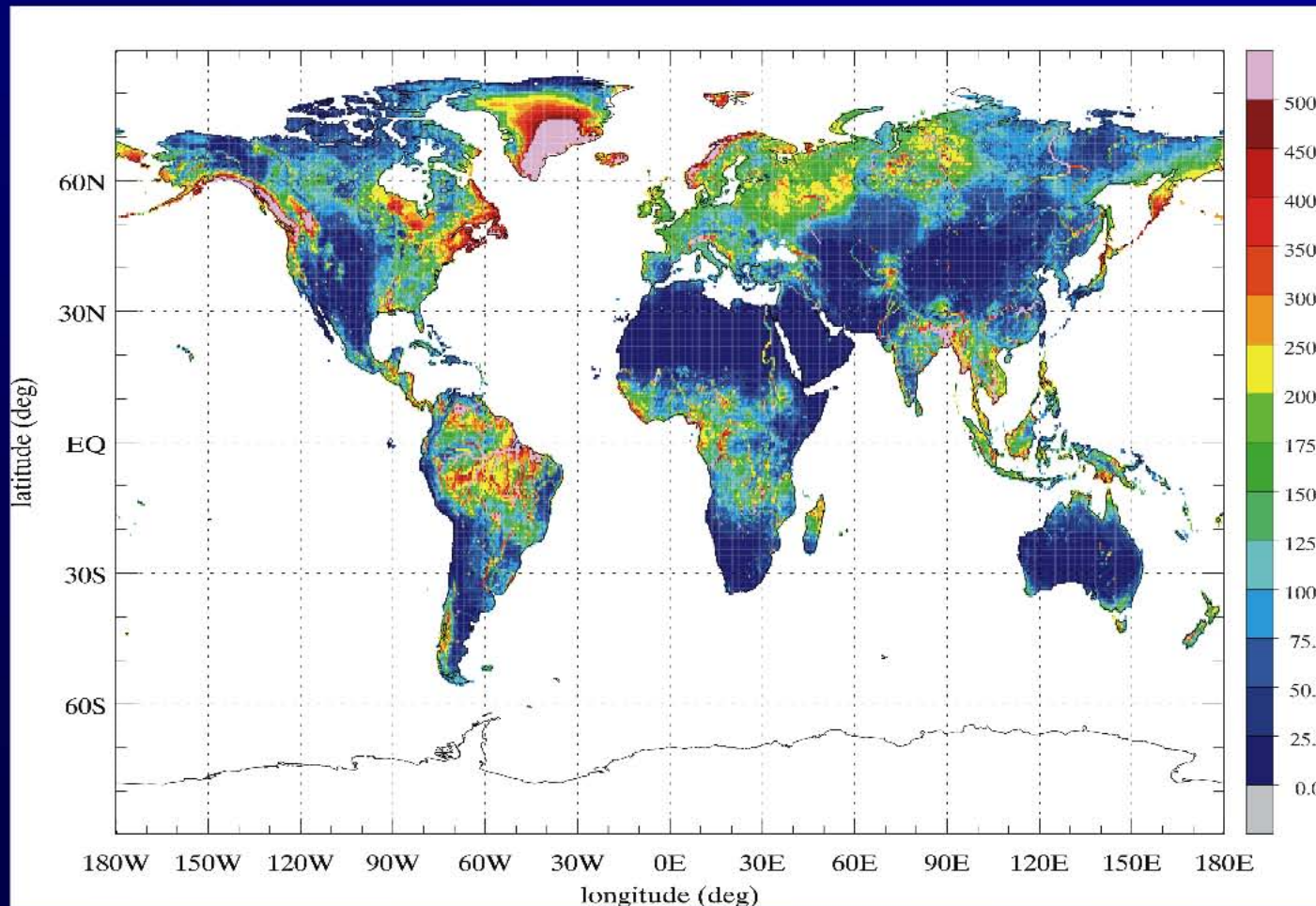



WGHM global modeling of the terrestrial water storage



Possible contributions to GRACE

- Global fields of fluctuations in terrestrial water storage for validation of GRACE time-variable gravity signal
- Time series of daily storage changes for separating the hydrological component of the GRACE integral signal

Geoid differences from monthly GRACE-only solutions & Variations of hydrological signal from Huang et al. model

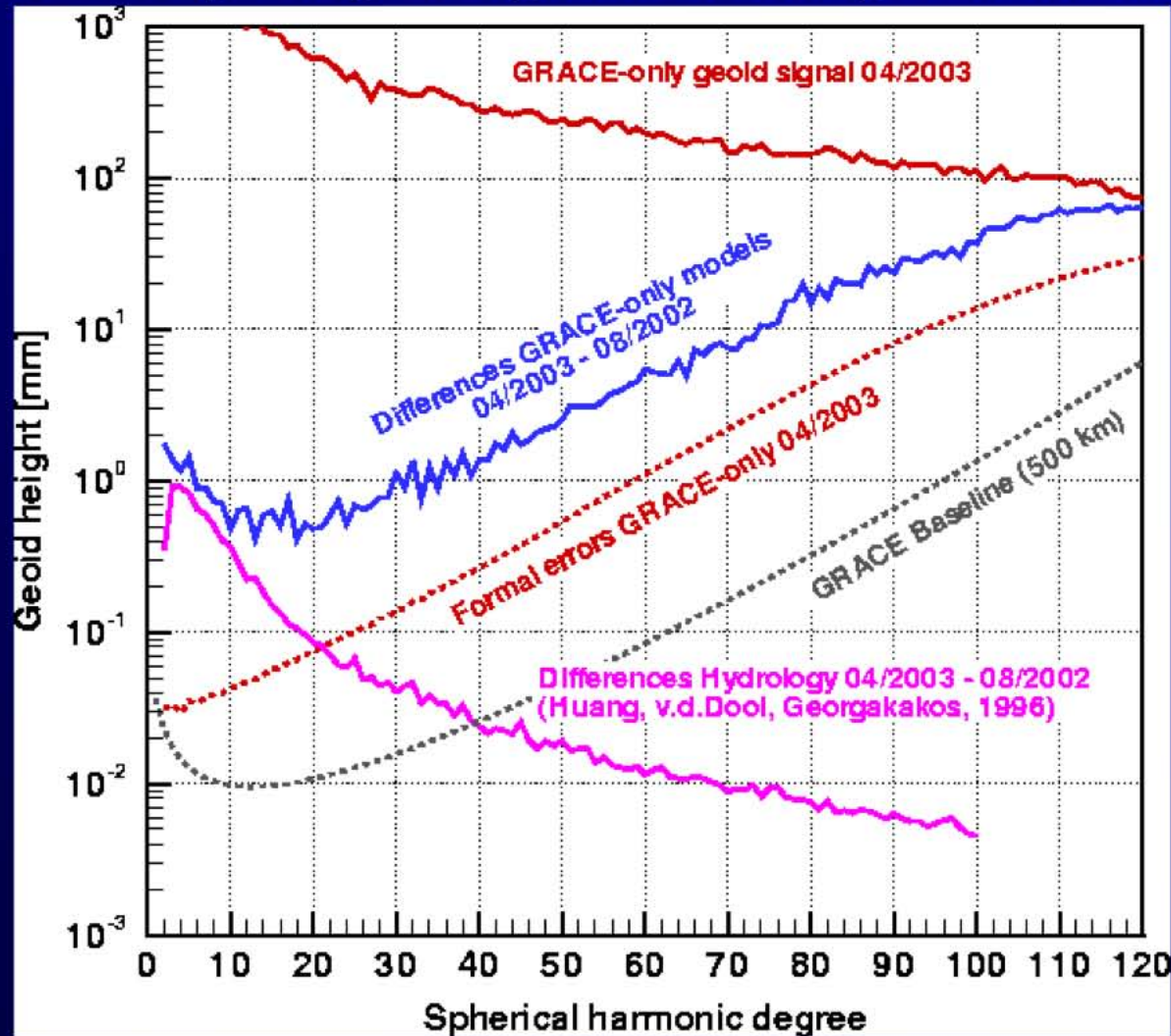

Δ GRACE-only sol. 04/2003 - 08/2002

(n = m = 10)

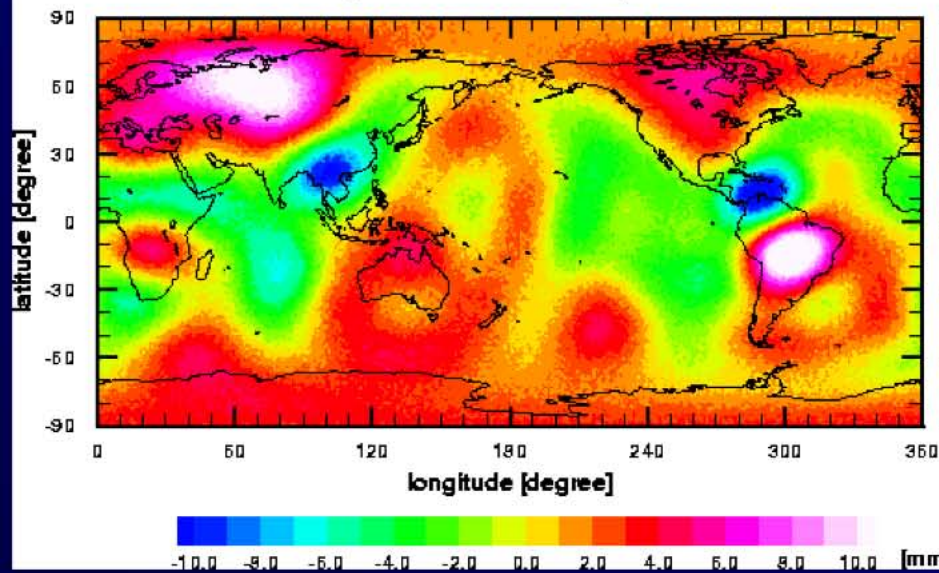

GRACE observation

Δ hydr. Mod. 04/2003 - 08/2002

(n = m = 10)

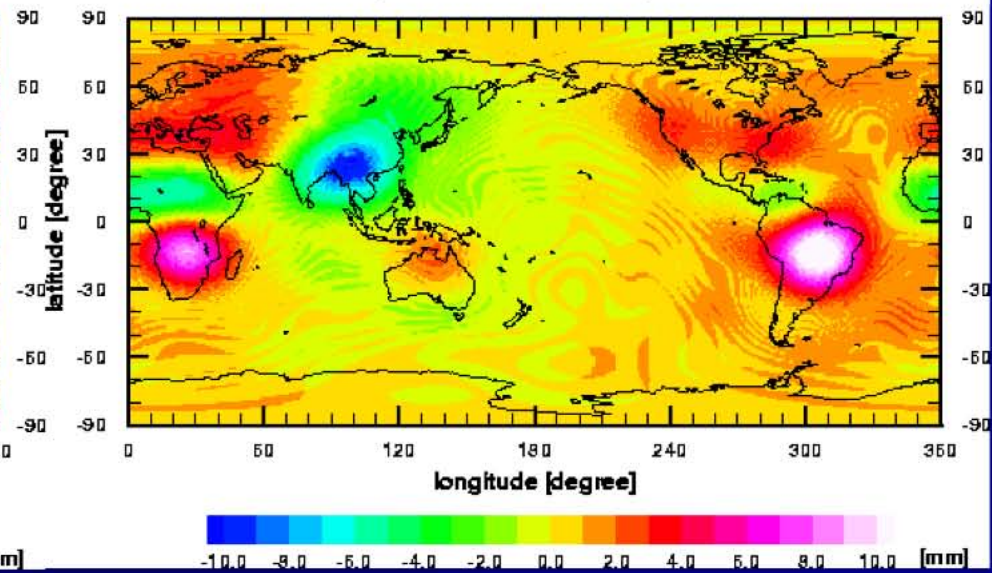

Model Prediction
(Huang et al. 1996,
Cont. 2003 by Fan)

Δ GRACE-only sol. 04/2003 - 08/2002

Δ GRACE-only sol. 04/2003 - 08/2002

(n = m = 10)

(hydro. signal correct. n = m = 10)

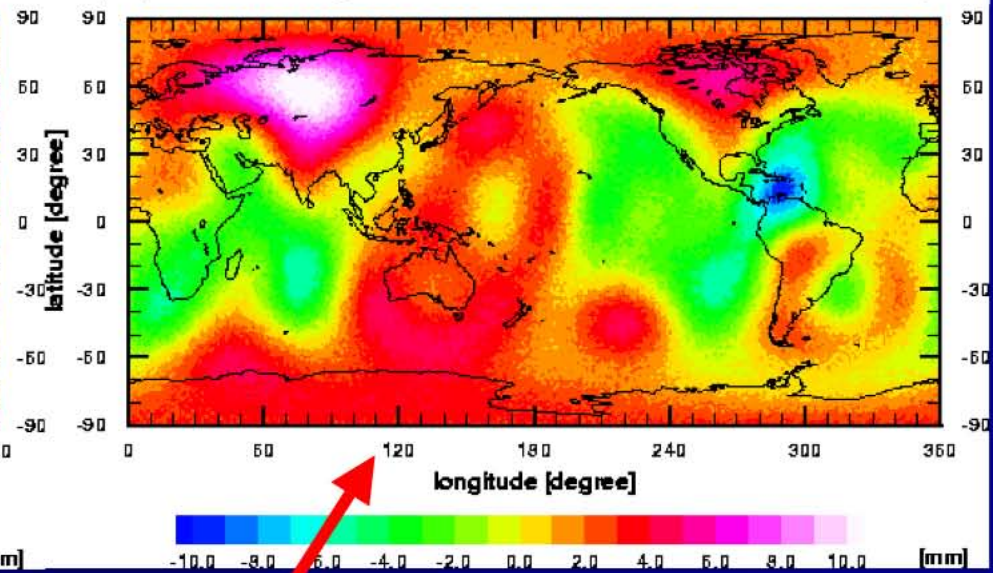
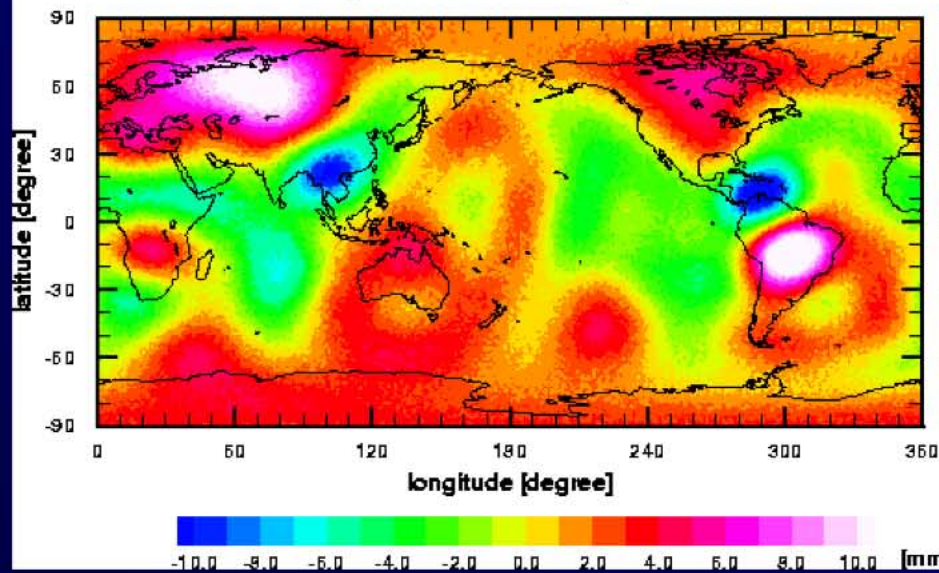

Gravity field coefficients up to degree and order 20 corrected by coefficients from hydrological model

Geoid differences from monthly GRACE-only solutions & Variations of hydrological signal from Huang et al. model scaled by a factor 1.3

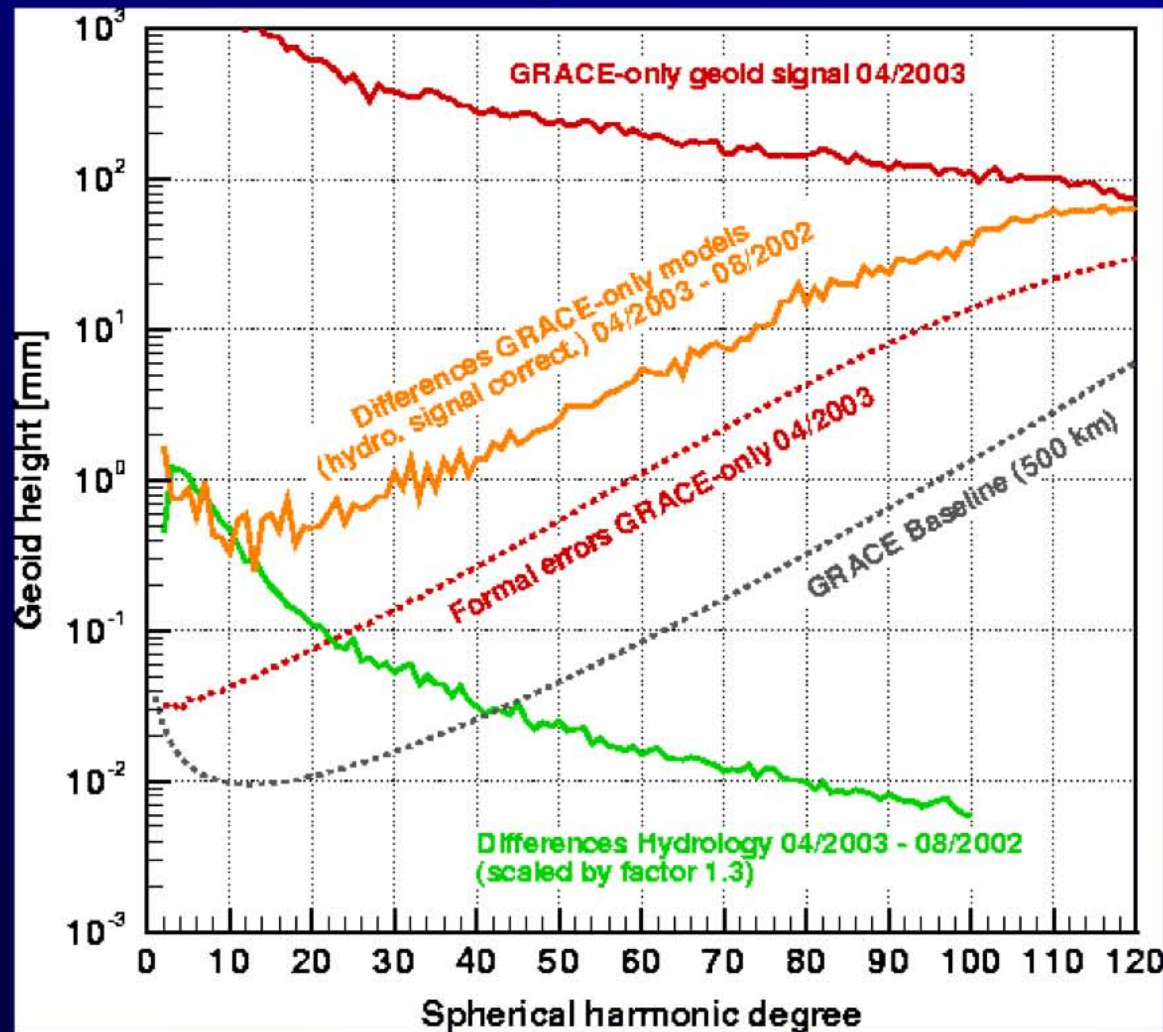

Δ GRACE-only sol. 04/2003 - 08/2002

($n = m = 10$)

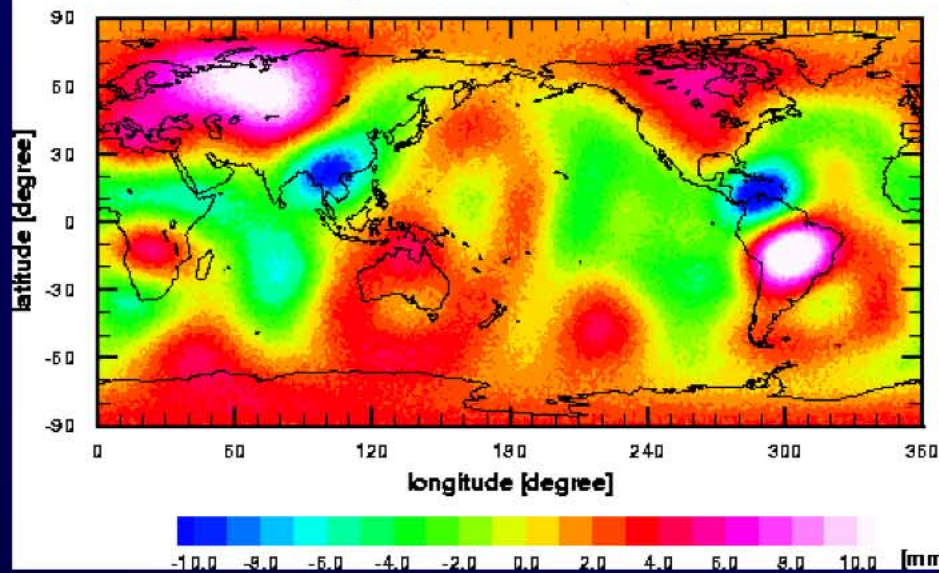

Δ GRACE-only sol. 04/2003 - 08/2002

(1.3*hydro. signal corr. $n = m = 10$)

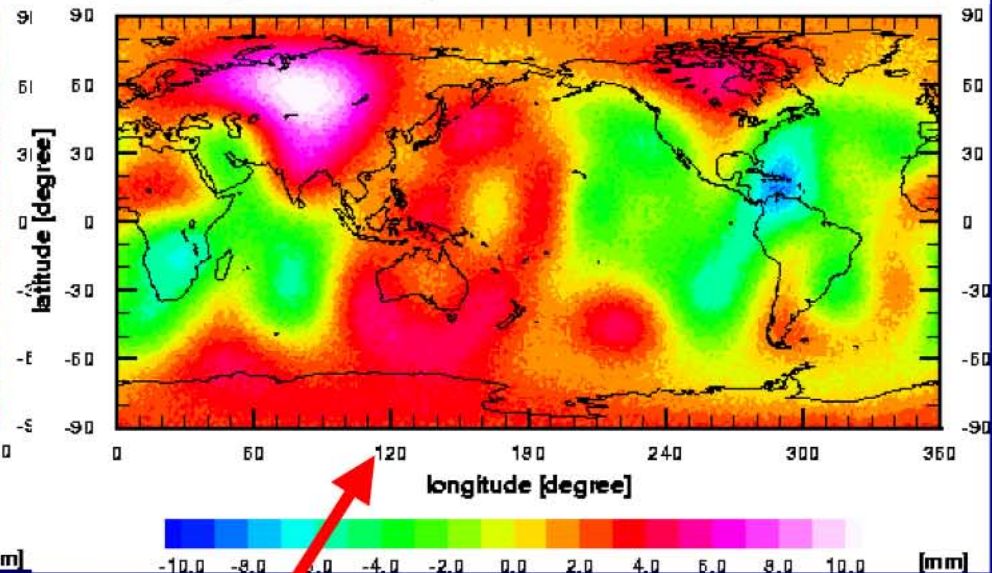

Gravity field coefficients up to degree and order 20 corrected by coefficients from hydrological model **scaled by factor 1.3**

Project Title:

**Terrestrial Water Storage Variations Using GRACE:
Estimation, Uncertainty, and Validation**

Team Members:

Jay Famiglietti(PI), UC Irvine

Clark Wilson, University of Texas at Austin

Matt Rodell , NASA GSFC

Jianli Chen, Center for Space Research

Ki-Weon Seo, University of Texas at Austin

Overall Objectives:

- 1) Produce monthly, seasonal, and annual GRACE-derived estimates of terrestrial water storage variations for selected watersheds and other hydrologically-significant regions around the globe
- 2) Characterize corresponding estimation uncertainty, including recognition of irregular boundaries and of temporal aliasing
- 3) Validate GRACE-derived water storage variation estimates by several methods, including observation-driven water balances, output from data-assimilating global models, and direct observation of water storage and aquifer level variations where available.

Implicit goals:

- 1) Build towards a framework for routine, global production and validation of monthly-to-annual basin-scale water storage change estimates and their uncertainties;
- 2) Provide modeled and observed data on high frequency terrestrial hydrological variations that can be used to assess the impact of temporal aliasing on estimation uncertainty and to guide future mission design.

First Year Objectives:

- 1) Identify locations where significant hydrologic variations are apparent from first GRACE products and to produce mass change estimates there; comparison to observations and model outputs
- 2) Identifying basins/regions (e.g. aquifers) for production of time series of water storage change estimates
 - develop the shape filter functions
 - perform spatial variance leakage and contamination studies
 - begin temporal aliasing studies
- 3) Begin assembling data sets for validation/comparison for the selected basins/hydrologic regions.

Potential Surface Water Drainage Basins

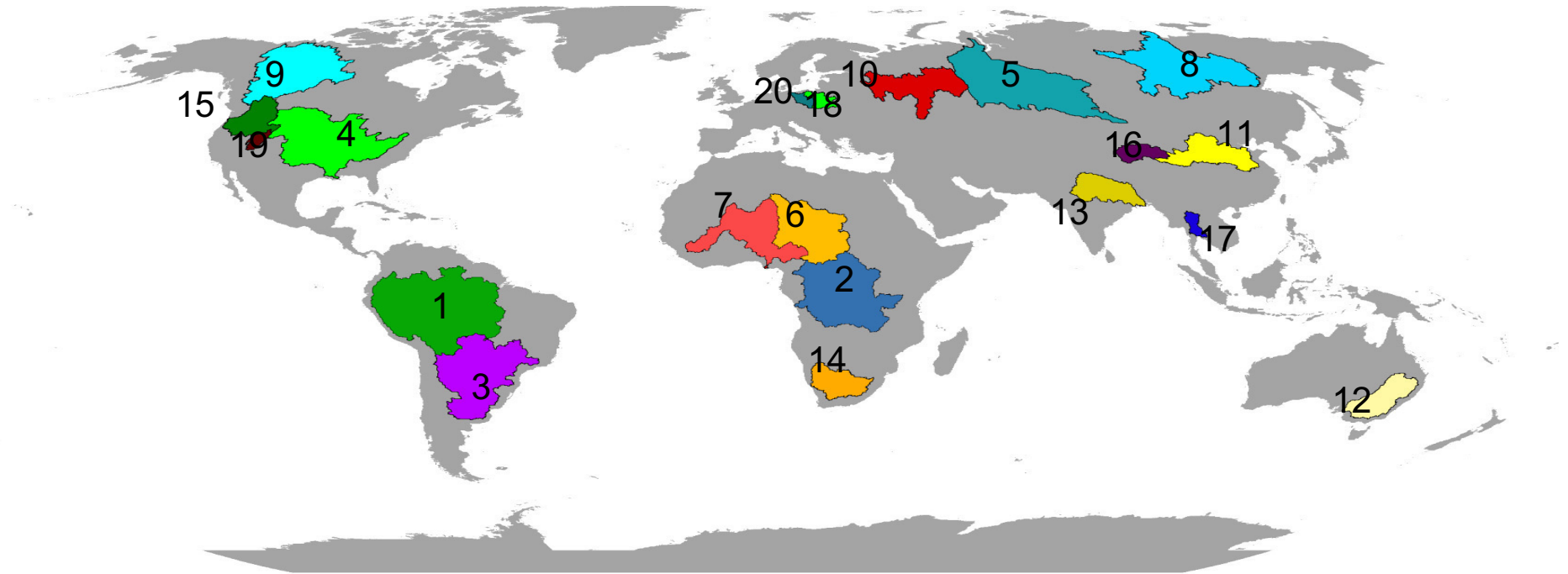

Number	Name	Area (km ²)	Number	Name	Area (km ²)
1	Amazon	5,782,000	11	Huang He (Yellow)	1,154,000
2	Zaire	3,788,000	12	Murray-Darling	1,009,000
3	Parana-Uruguay	3,375,000	13	Ganges	997,000
4	Mississippi	3,166,000	14	Oranje	932,000
5	Ob	3,143,000	15	Columbia	817,000
6	Lake Chad	2,416,000	16	Tibetan Plateau	416,000
7	Niger	2,306,000	17	Chao Phraya	201,000
8	Lena	2,273,000	18	Wisla	184,000
9	Mackenzie	1,933,000	19	Great Salt Lake	142,000
10	Volga	1,290,000	20	Odra	130,000

Rodell and Famiglietti (1999)

Potential Groudwater Aquifer Studies

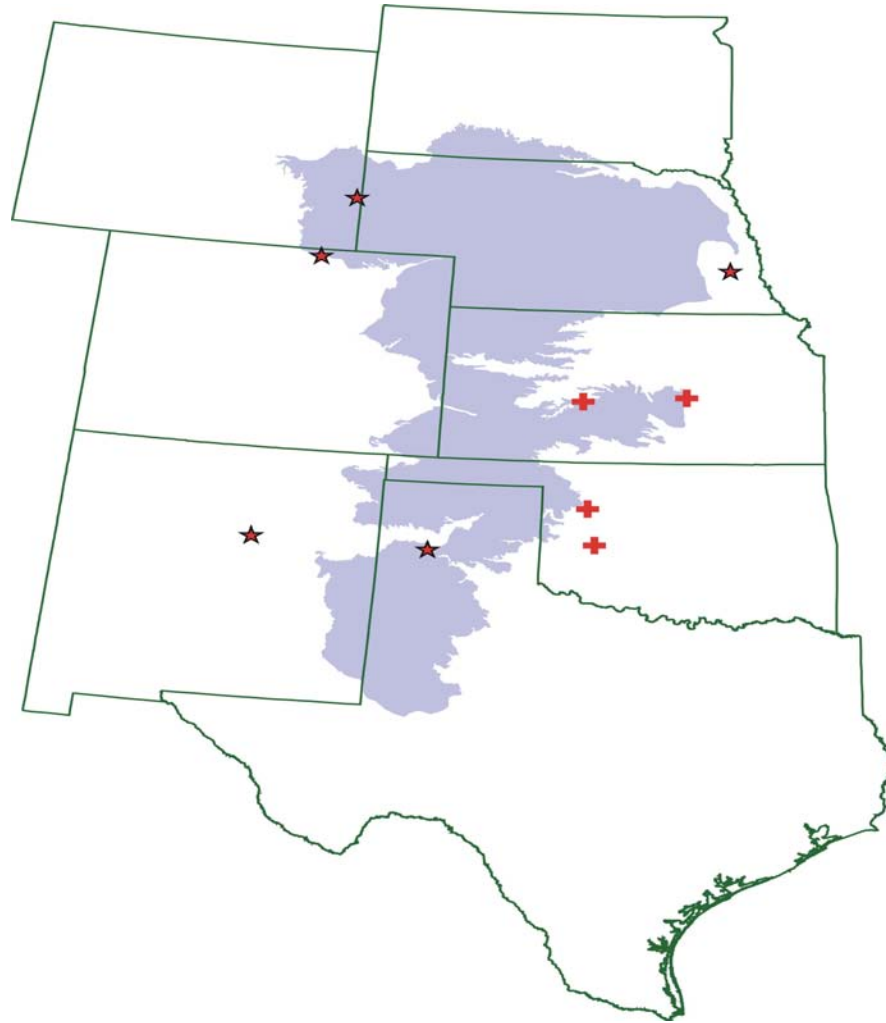

High Plains Aquifer, Central U.S.

Rodell and Famiglietti, 2002

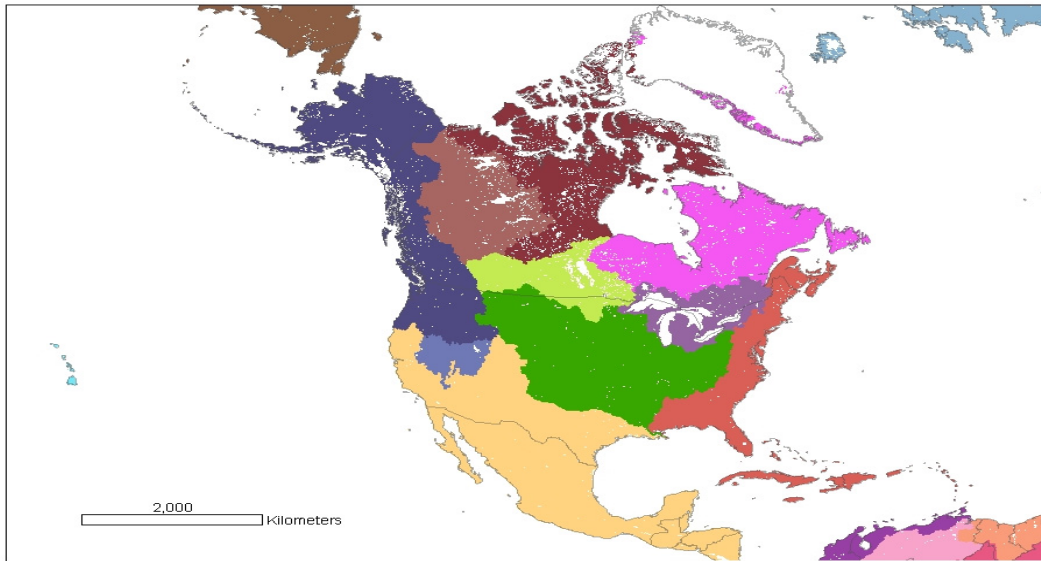

Pfafstetter level 1 basins for North America.

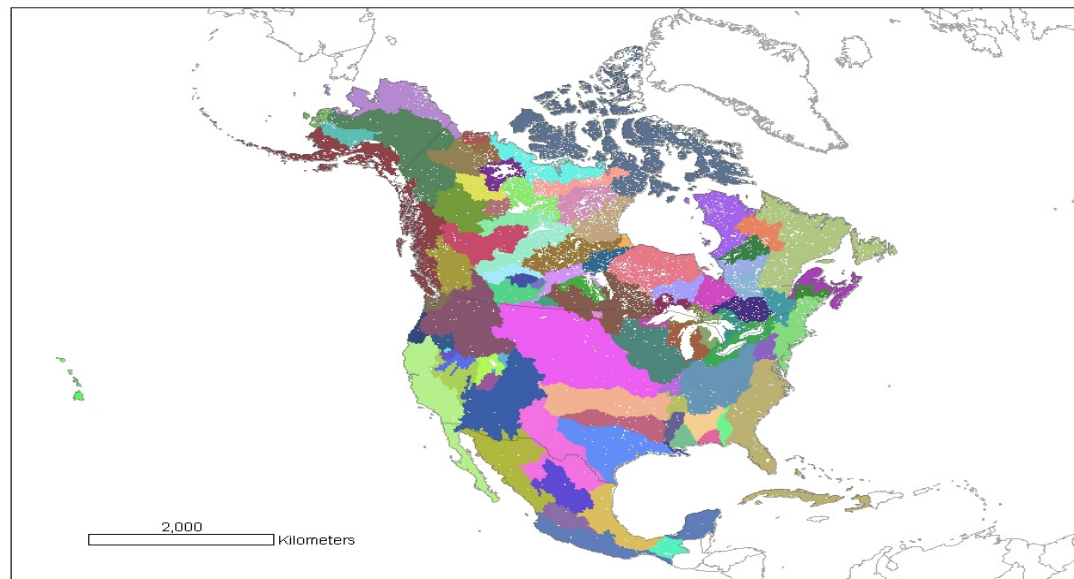

Pfafstetter level 2 basins for North America.

Discretization of Land Surface into Large Drainage Regions

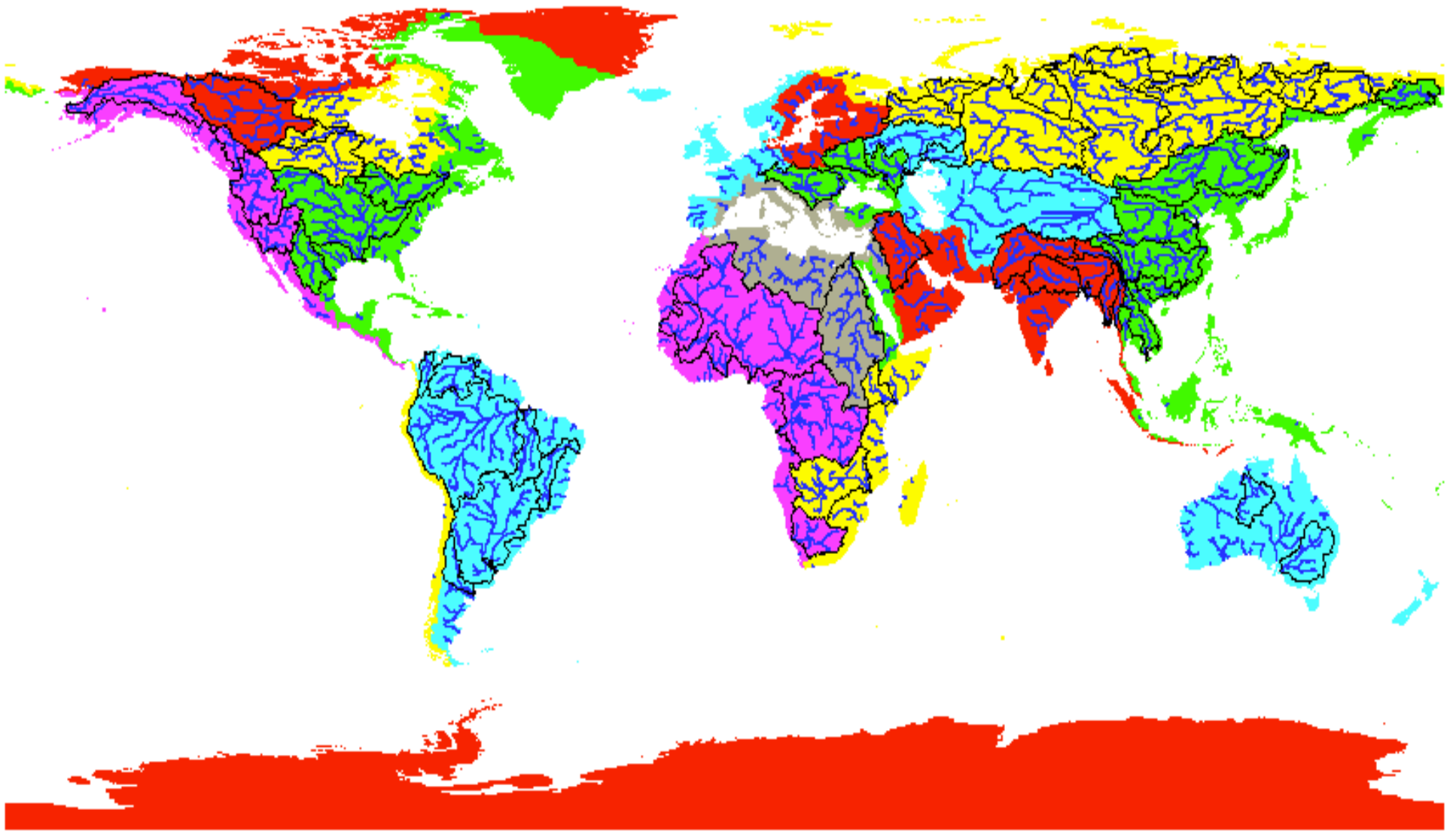

Role of Global Hydrological Modeling GLDAS Framework

Surface Soil Moisture

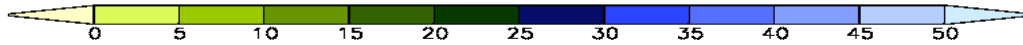
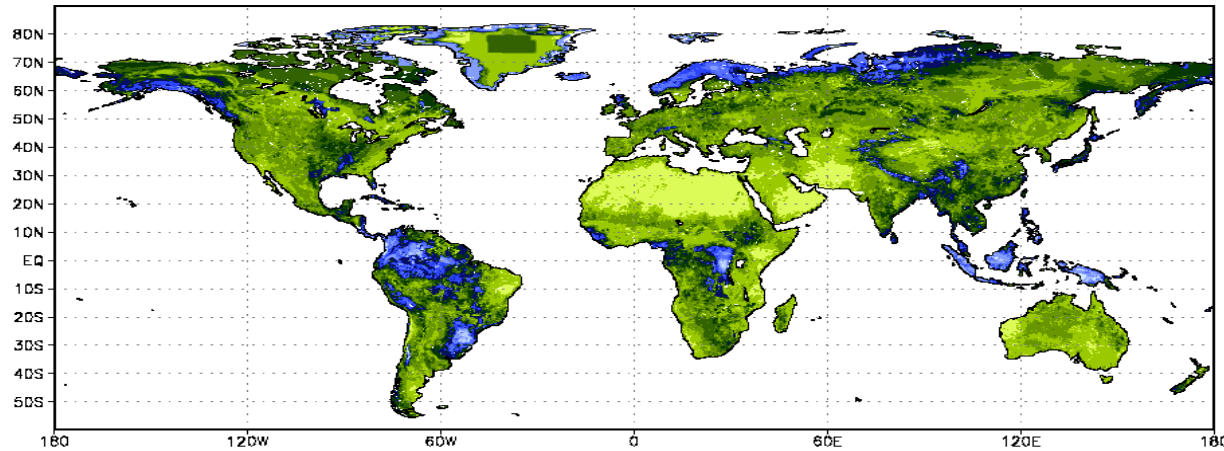

Change in Total Water Storage

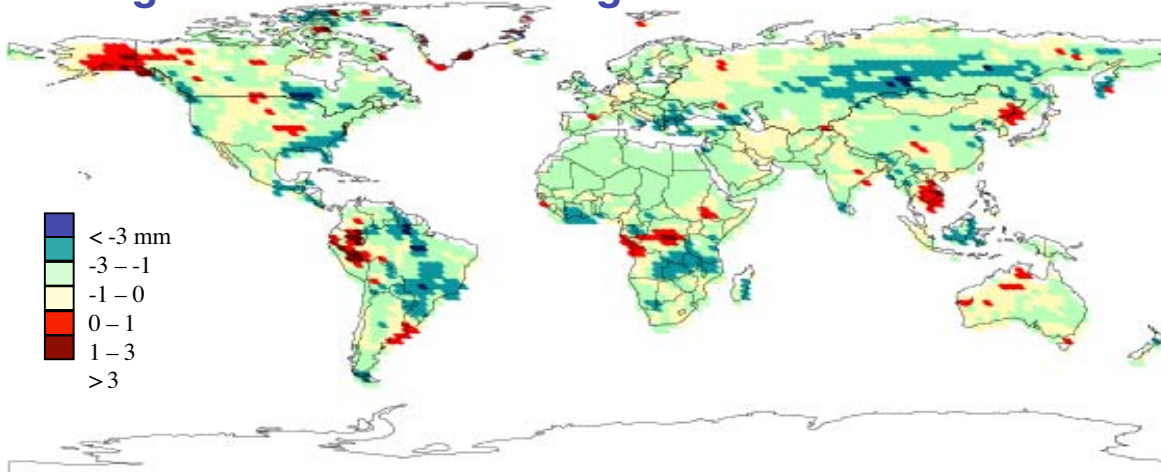

- Temporal aliasing
- Comparison/validation
- Signal separation

High Frequency Hydrologic Variations for Temporal Aliasing

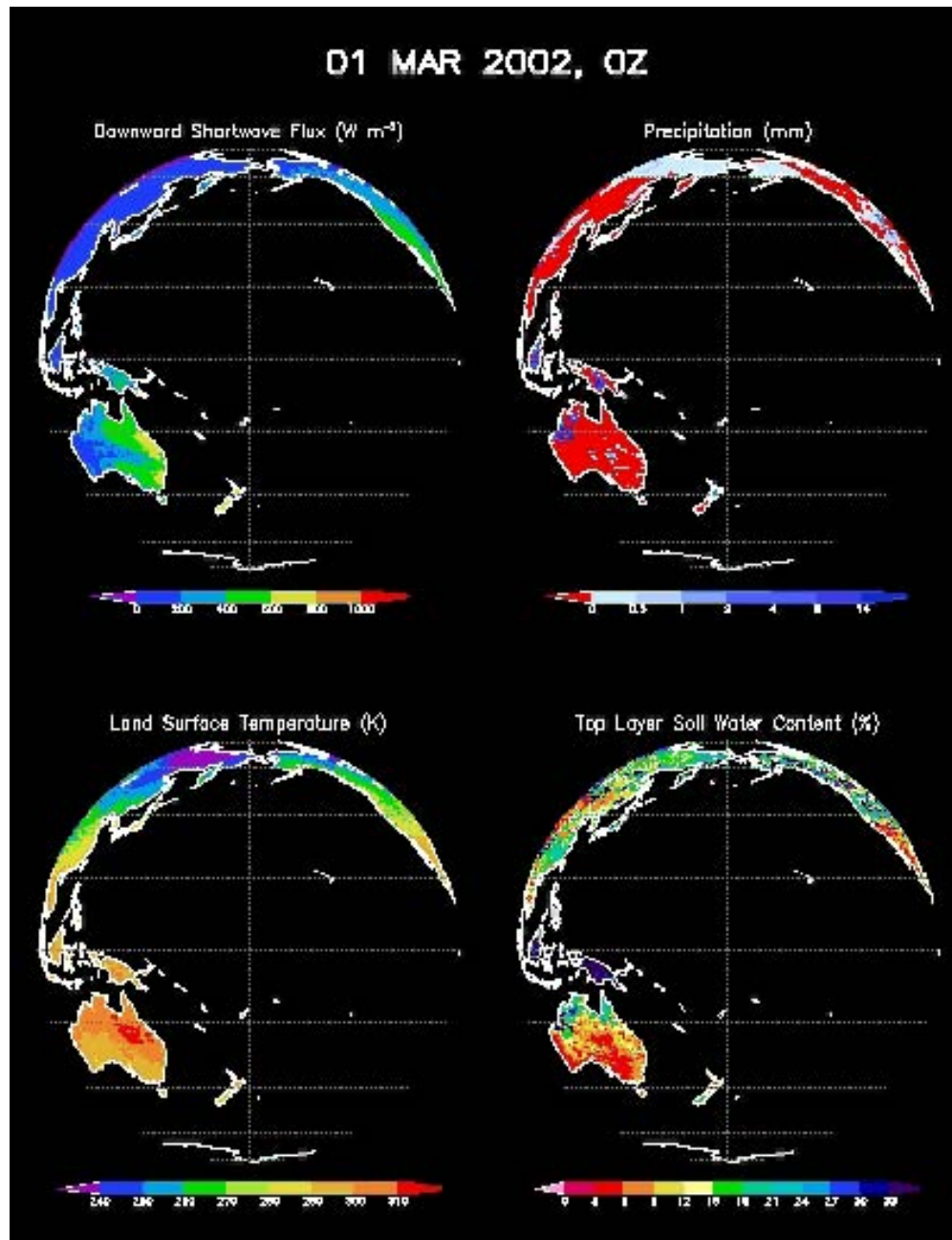

NASA GLDAS
Rodell et al., 2003



Ocean Bottom Pressure Experiment: A Ground-truth Site for GRACE

Send U.¹⁾ , Kanzow T.¹⁾ , Miller H.²⁾ , Reigber Ch.³⁾

- 1) Institut for Marine Research, Kiel, Germany**
- 2) Alfred-Wegener-Institut, Bremerhaven, Germany**
- 3) GeoForschungsZentrum, Potsdam, Germany**



Ocean Bottom Pressure Val. Experiment



- **Goal:** Joint validation experiment of oceanographic and geodetic institutions
- **Basis:** use of existing oceanographic experiment MOVE (Meridional Overturning Variability Experiment), in operation since Jan. 2000, array of 3 moorings in the tropical western Atlantic M1-M3 (1000 km apart)
- **Plan:** Extension from 02/2004 onwards by additional 4 moorings M4-M7



Ocean Bottom Pressure Val. Experiment



- **Technology:**

- bottom pressure inverted echosounder (PIES) by R. Watts (URI),
- sensors: quartz crystal resonators, resolution 0.1 mbar (equivalent to 1 mm water column height),
- 1 measurement/hour,
- upgrade (2004) with Acoustic Telemetry will allow acoustic read-out (no need for recovery any more)





Ocean Bottom Pressure Val. Experiment



- **Problem:** long-term drift of the PIES instrument
empirical detrending necessary (see example)
- **Application:** sub-annual true ocean bottom pressure
fluctuations (ground-truth for GRACE)
- **Data Availability:** Jan. 2000 through June 2003 available
from mooring sites M1 – M3,
first retrieval of M4 and M5: one year after
deployment, data retrieval cruises planned
at annual intervals

Location of OBP Recorders

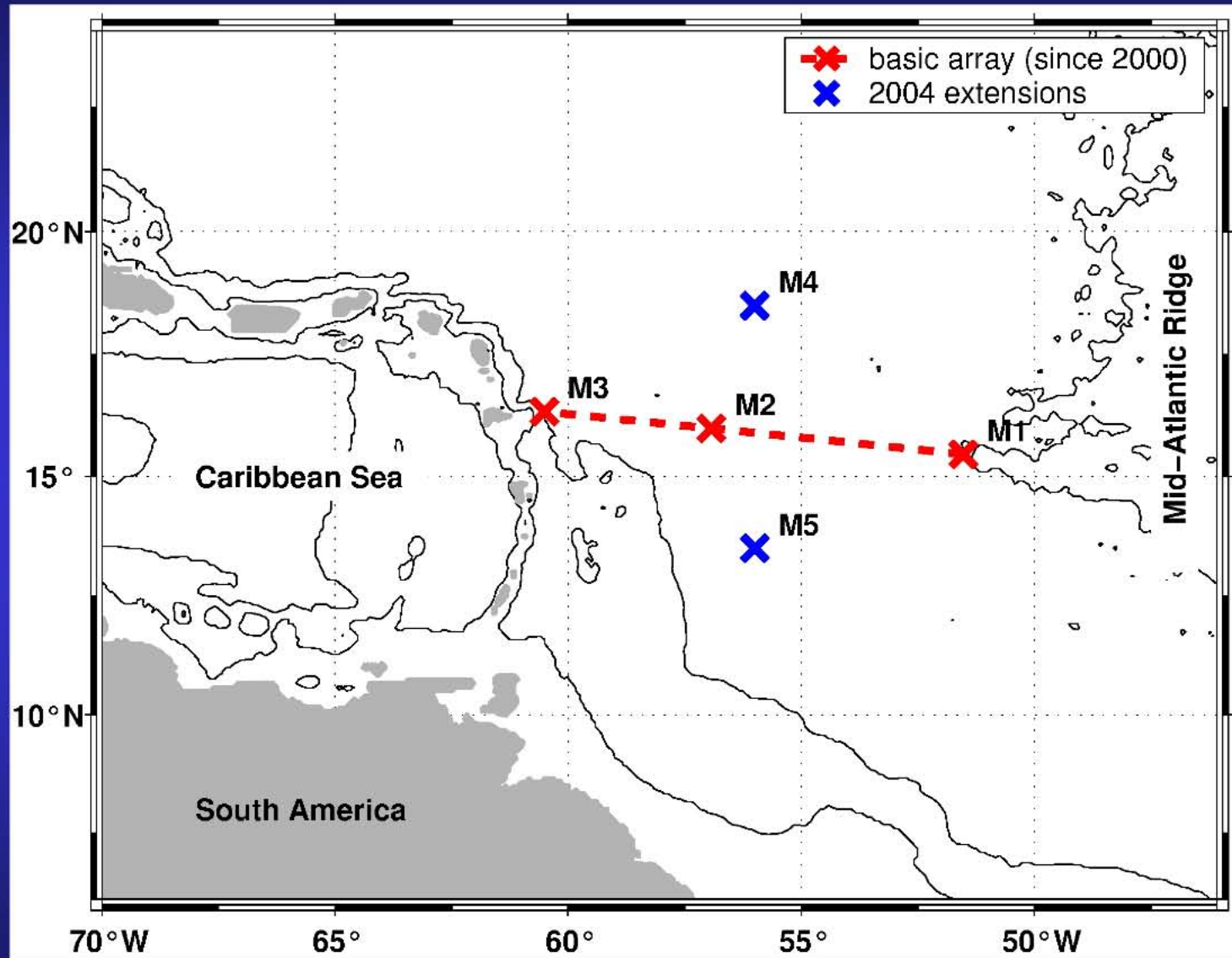

OBP Recorder Data from M1 & M3 (original and detrended series)

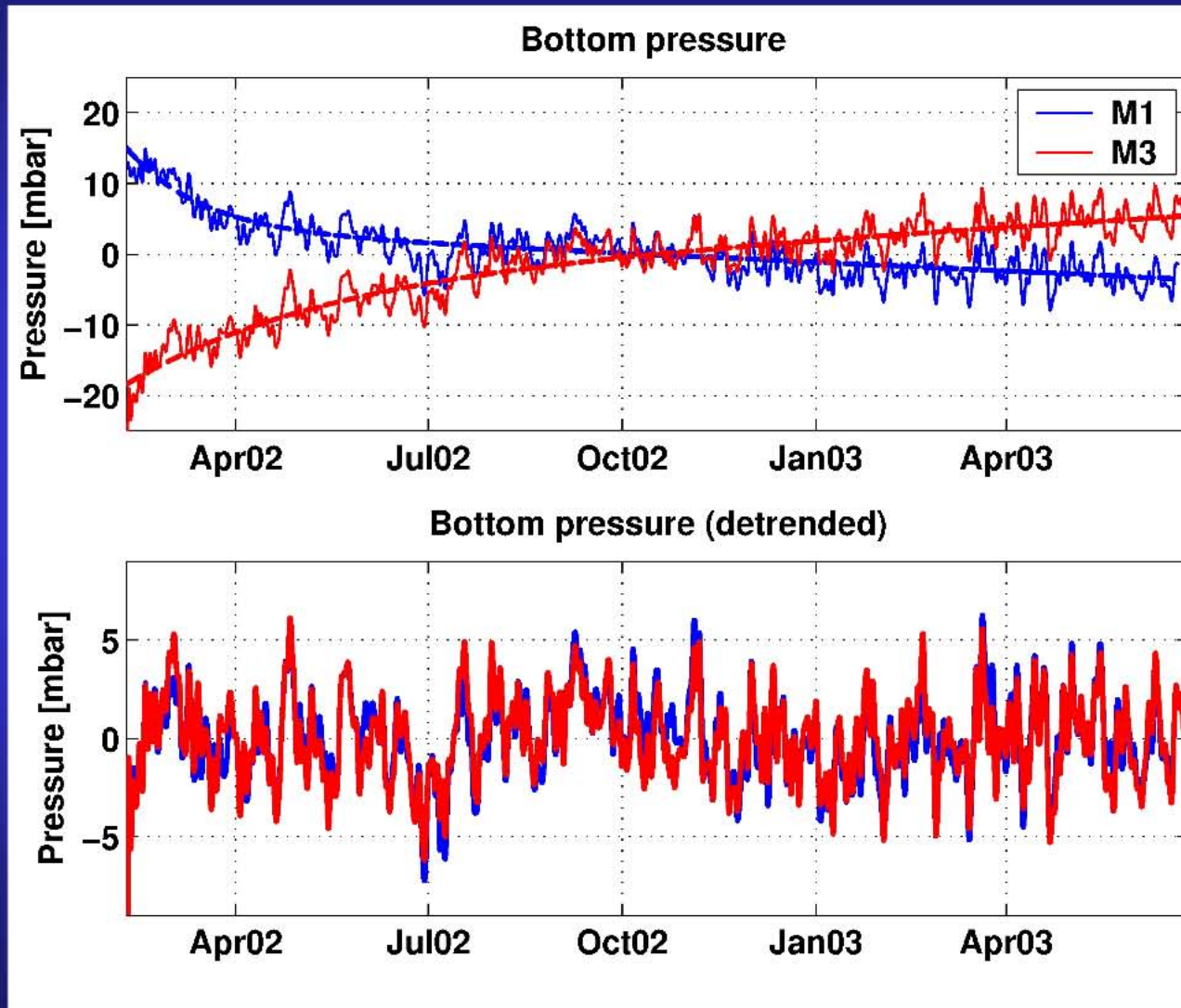



Complete OBP data set since 01/2000 (detrended)

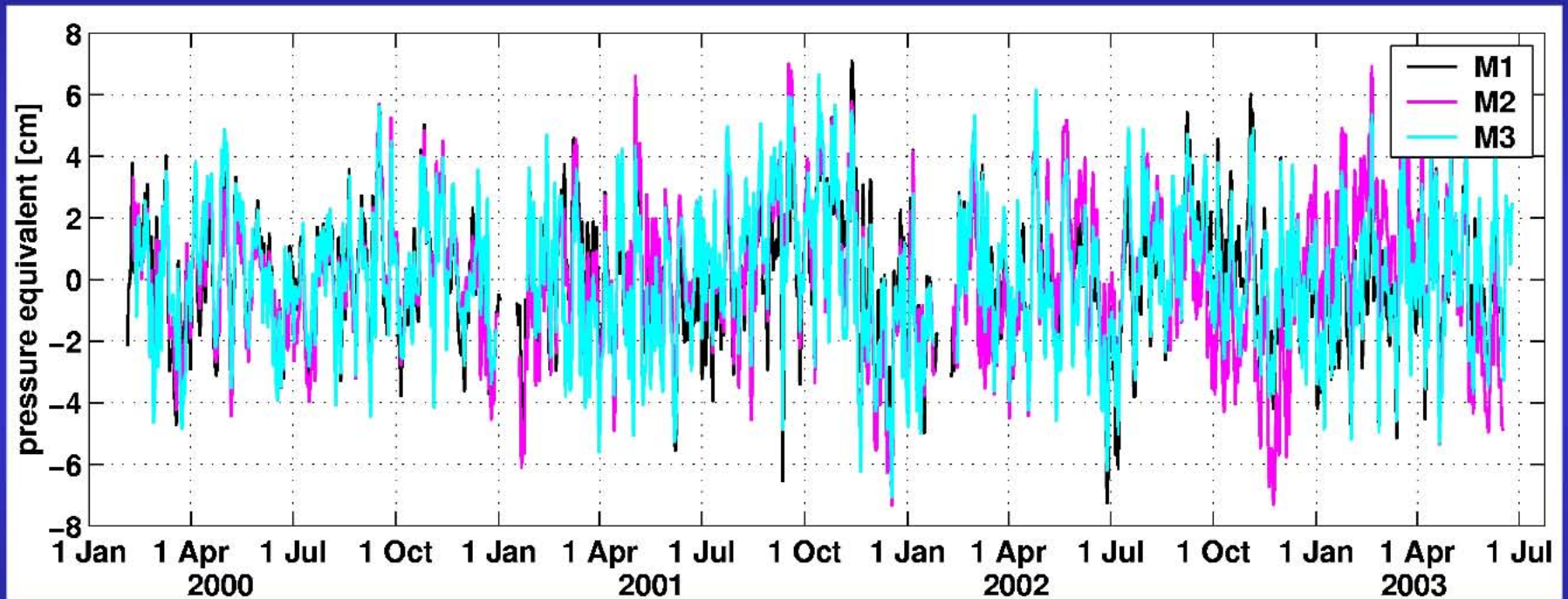

GRACE Science Team Meeting
October 8-10, 2003
Center for Space Research,
University of Texas at Austin

Calibration/Validation of GRACE-derived gravity fields using the ground data obtained in the Japanese Antarctic Research Expedition area and Syowa Station, Antarctica

Kazuo Shibuya and 11 co-investigators

Short Title : Validation of GRACE data from Syowa data

Abstract

We are planning to detect the gravitational effects related with the ice sheet thinning (10 – 20 cm/year) of the Shirase Glacier drainage basin, change of ocean dynamics around the Lutzow-Holm Bay region, and postglacial rebound in the Japanese Antarctic Research Expedition (JARE) area from the GRACE-derived time-series of gravity fields. The GRACE Level 1/2 data will be compared and interpreted with the Syowa Station geodetic observations (VLBI, GPS, DORIS, sea level meter, superconducting gravimeter, absolute gravimeter, synthetic aperture radar scenes, surface synoptic observations, etc.) and regional marine and oversnow geophysical/glaciological archived data. New surveys to have precisely calibrated gravity values (10 - 20 μ gal absolute accuracy) are planned on the ice sheet of JARE area, while ocean bottom pressure sensors will be deployed in the surrounding oceans to know actual mass changes of the ocean area.

Research Proposal for GRACE from the NIPR-JARE Group

Main Targets

- Ice sheet thinning of the Shirase Glacier drainage basin
- Ocean dynamics around the L_tzow-Holm Bay region
- Postglacial rebound in the JARE research area

Low-Low SST

- GRACE

- Microwave Link

$1 \mu\text{m/s}$ \rightarrow 1 mm Geoid

- GRACE-FO

- Laser Link

$> 0.01 \mu\text{m/s}$ \rightarrow 0.01 mm Geoid

GEOID Variation Due to Ice sheet Mass Load

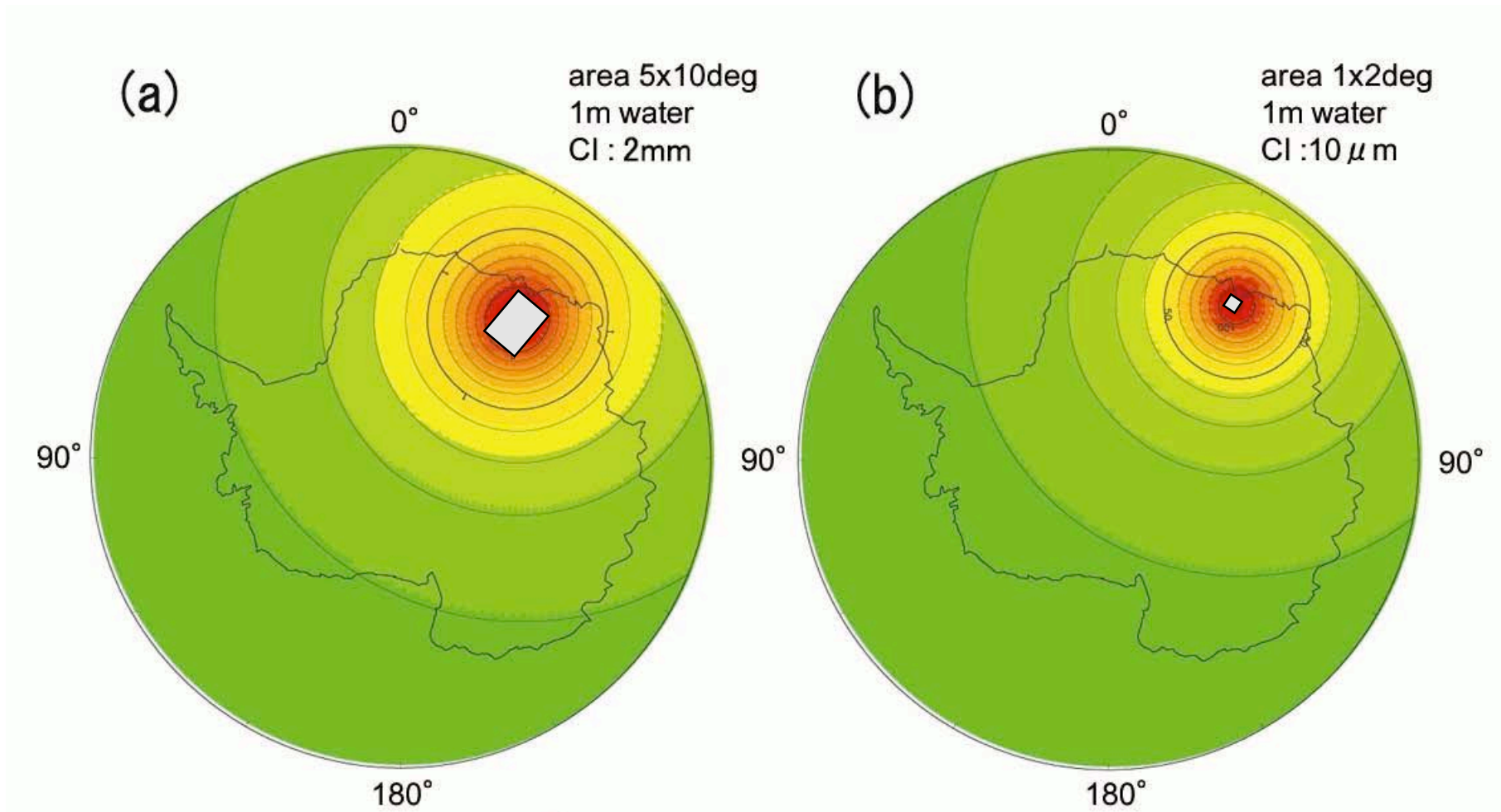

1 mm Geoid (GRACE)
Geoid(GRACE-FO)

0.01 mm

JARE Observations

Geodetic Observations

- VLBI, GPS, DORIS
- TIDE GAUGE
- SG, AG (IGSNA)

Glaciological Observations

- Ice sheet surface configuration
- Snow accumulation, ablation
- Snow density, temperature profile
- Prevailing wind field

Meteorological Observations

Satellite Monitoring

- NOAA, DMSP, ADEOS- II , ERS-2 ongoing
- ALOS planned
- ERS-1, JERS-1 archiving

Observation Schedule

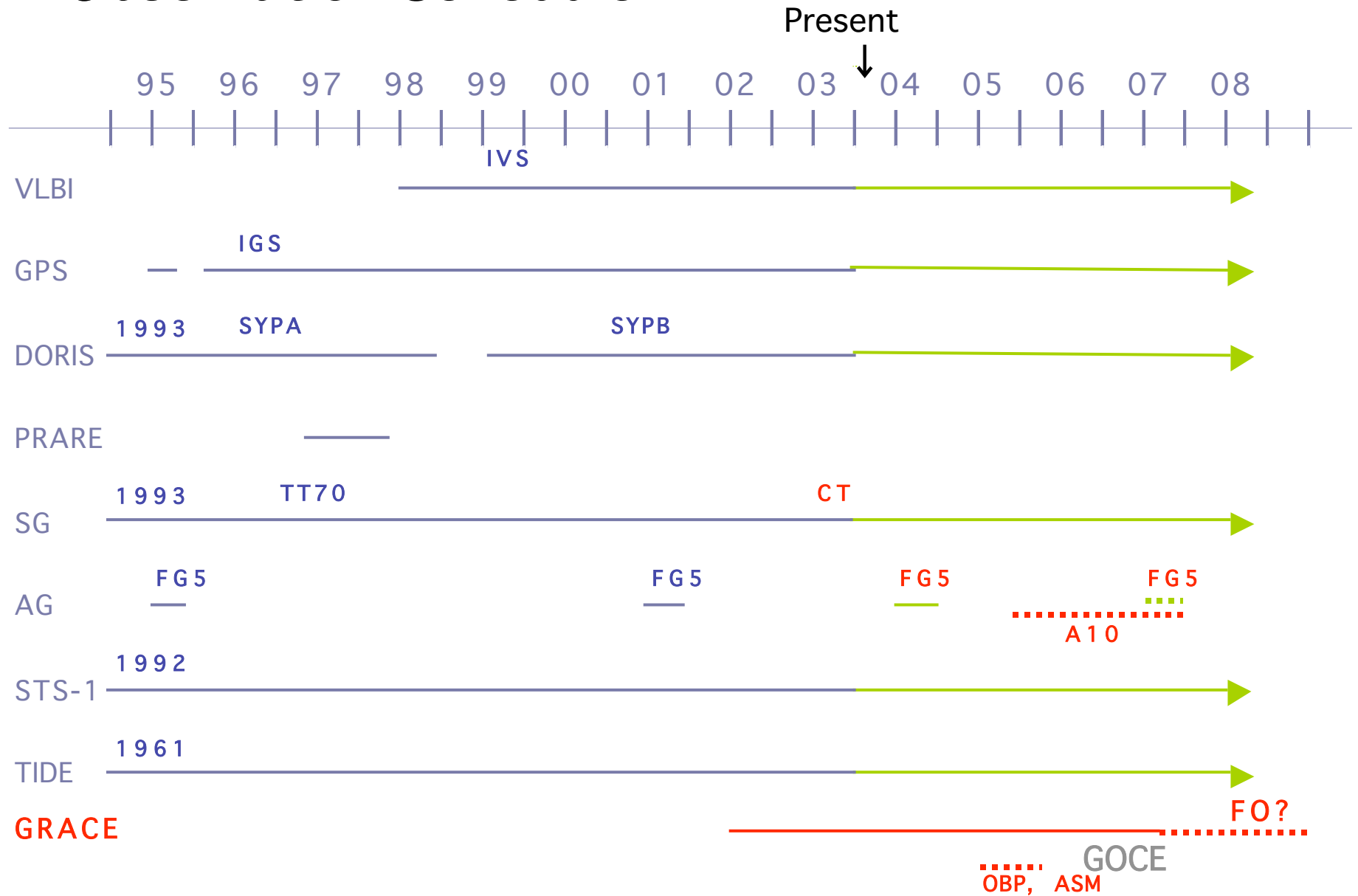

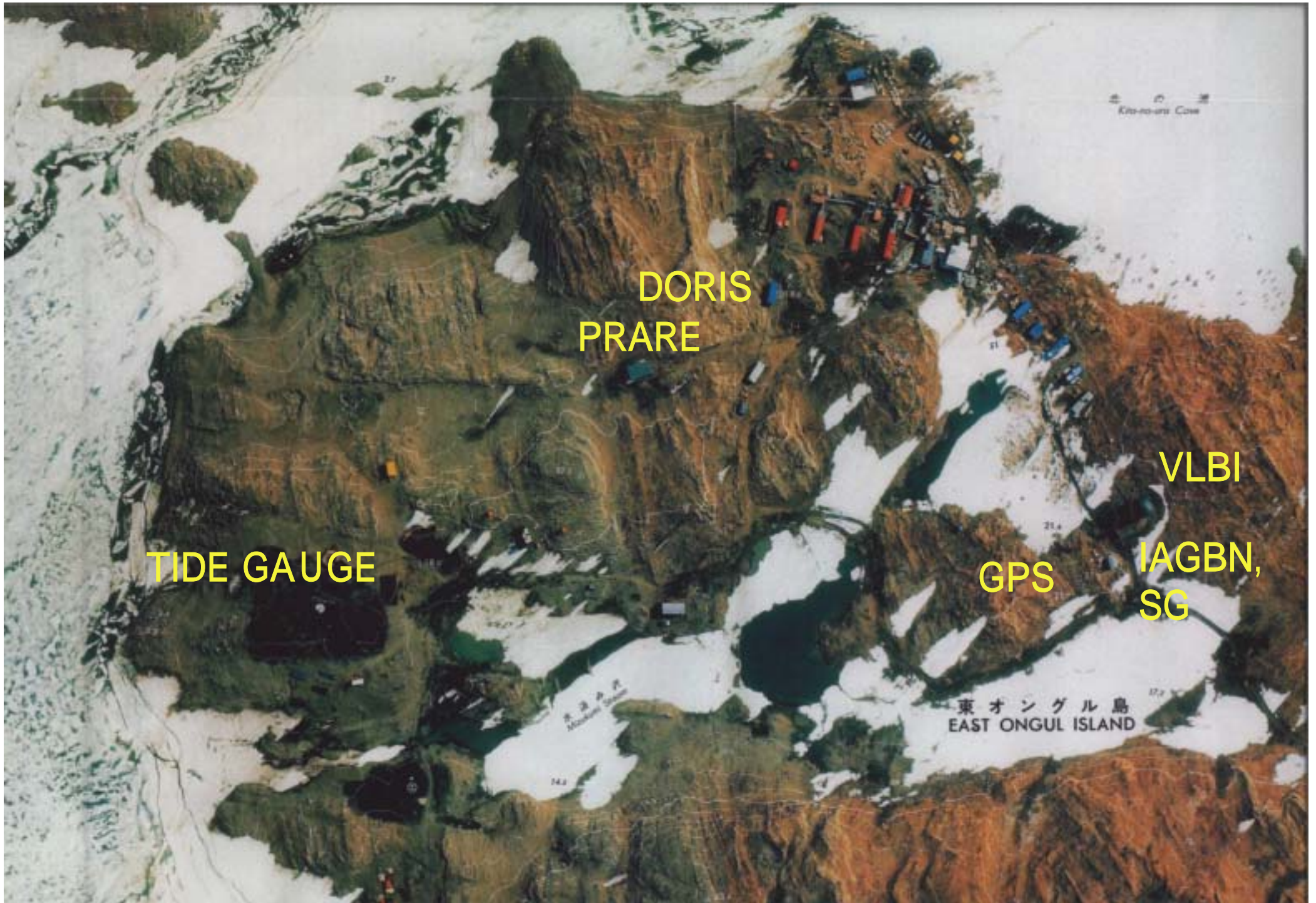

DORIS
PRARE

TIDE GAUGE

GPS

VLBI

IAGBN,
SG

東オングル島
EAST ONGUL ISLAND

北の海
Kito-no-umi Cove

Gravity observation hut

SG (TT-70)

AG (FG-5)



Summary of the Field Program for the year 2003 _ 2004

- a. Parallel measurements of absolute gravity by using two FG5 gravimeters in the gravity observation hut.
- b. Continue GWR CT(#043) superconducting gravimeter observations. Calibration of the scale factor by FG5.
- c. Continue VLBI, GPS, DORIS, BPG (ocean tide) observations.
- d. On Mizuho Plateau (on the ice sheet near Syowa Station), dense polygonal surveys (10 km x 10 km) with LaCoste Romberg gravimeters/dual frequency GPS receivers will be made.

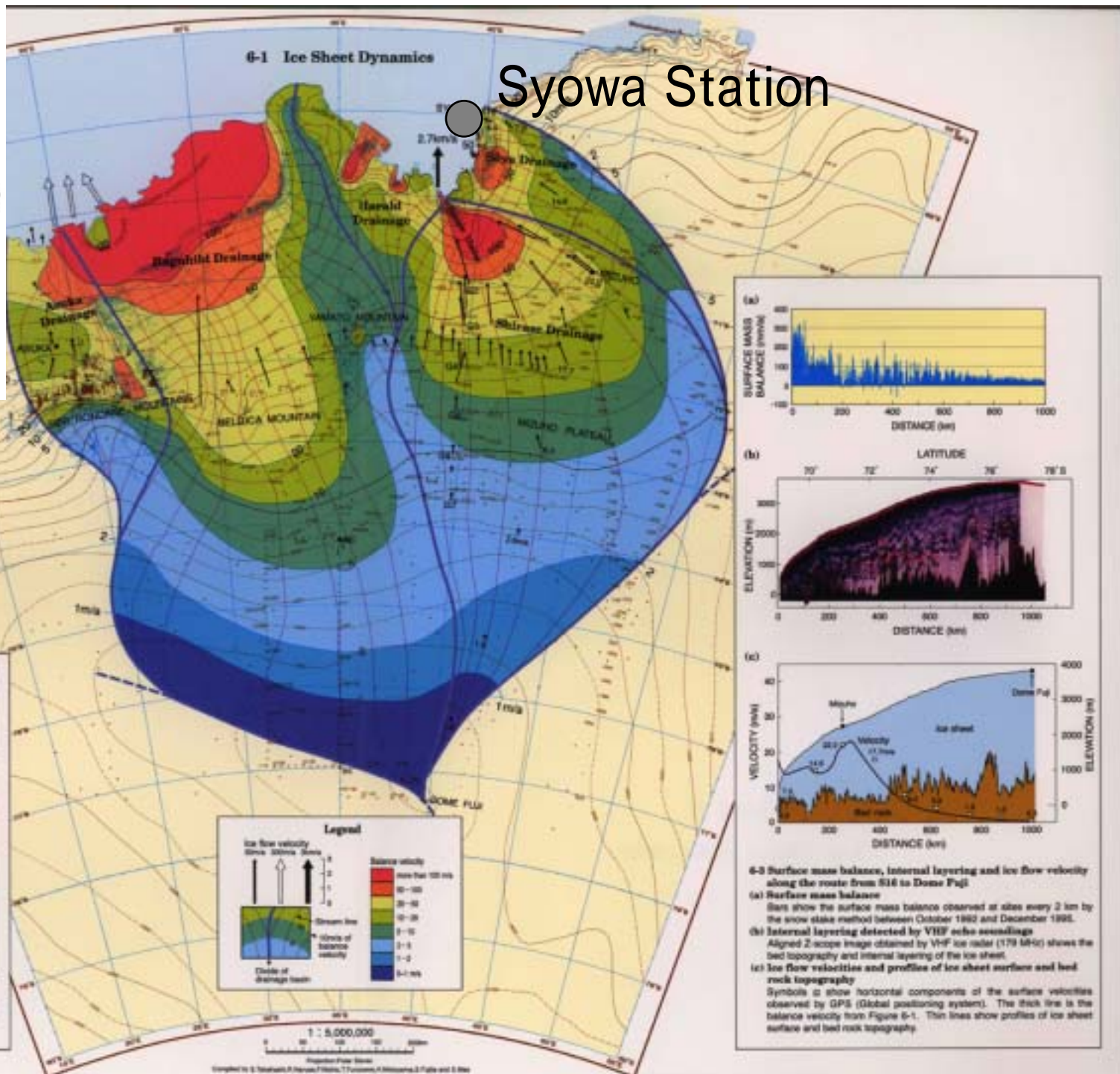
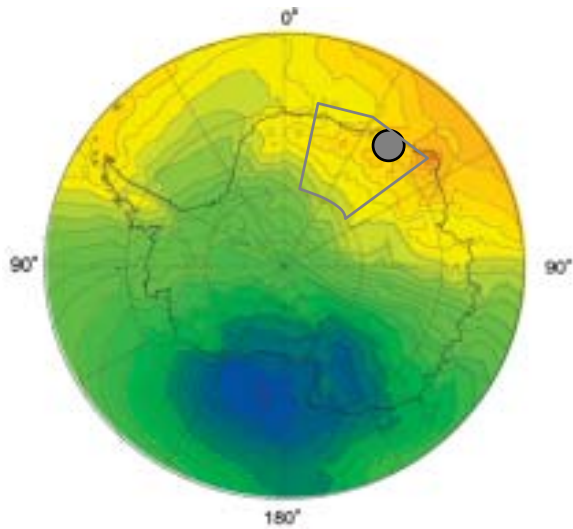

6-2 Surface ice flow along the SS profile (about 49° E)
Ice flow measurement data were obtained along the SS route by the NNSS (Navy Navigation Satellite System). The distance is from the mouth of Shirase Glacier.

(a) Ice flow velocities
Symbols \square show horizontal components of the observed surface velocity. A solid line shows balance velocity along a stream line near the SS route.

(b) Profile of ice sheet surface and bedrock topography
Surface elevation was obtained by NNSS positioning and barometric altimetry. Bedrock topography was measured by radio-echo sounding. Arrows show horizontal flow velocity at each site.

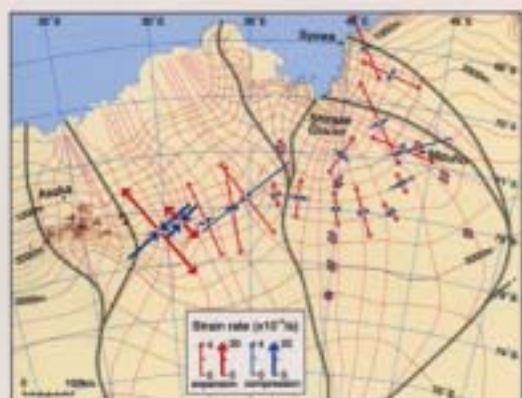

6-4 Strain rate of the ice sheet surface
Strain rate was obtained by the deformation of a strain grid (1 km x 1 km) over several years. The pair of red arrows shows expansion strain rate and the pair of blue arrows compression strain rate.

6-3 Surface mass balance, internal layering and ice flow velocity along the route from S16 to Dome Fuji
(a) Surface mass balance
Bars show the surface mass balance observed at sites every 2 km by the snow stake method between October 1992 and December 1995.
(b) Internal layering detected by VHF ice radar
Aligned Z-scope image obtained by VHF ice radar (179 MHz) shows the bed topography and internal layering of the ice sheet.
(c) Ice flow velocities and profiles of ice sheet surface and bed rock topography
Symbols \square show horizontal components of the surface velocities observed by GPS (Global positioning system). The thick line is the balance velocity from Figure 6-1. Thin lines show profiles of ice sheet surface and bed rock topography.

Precise Gravity Measurements on the Ice sheet

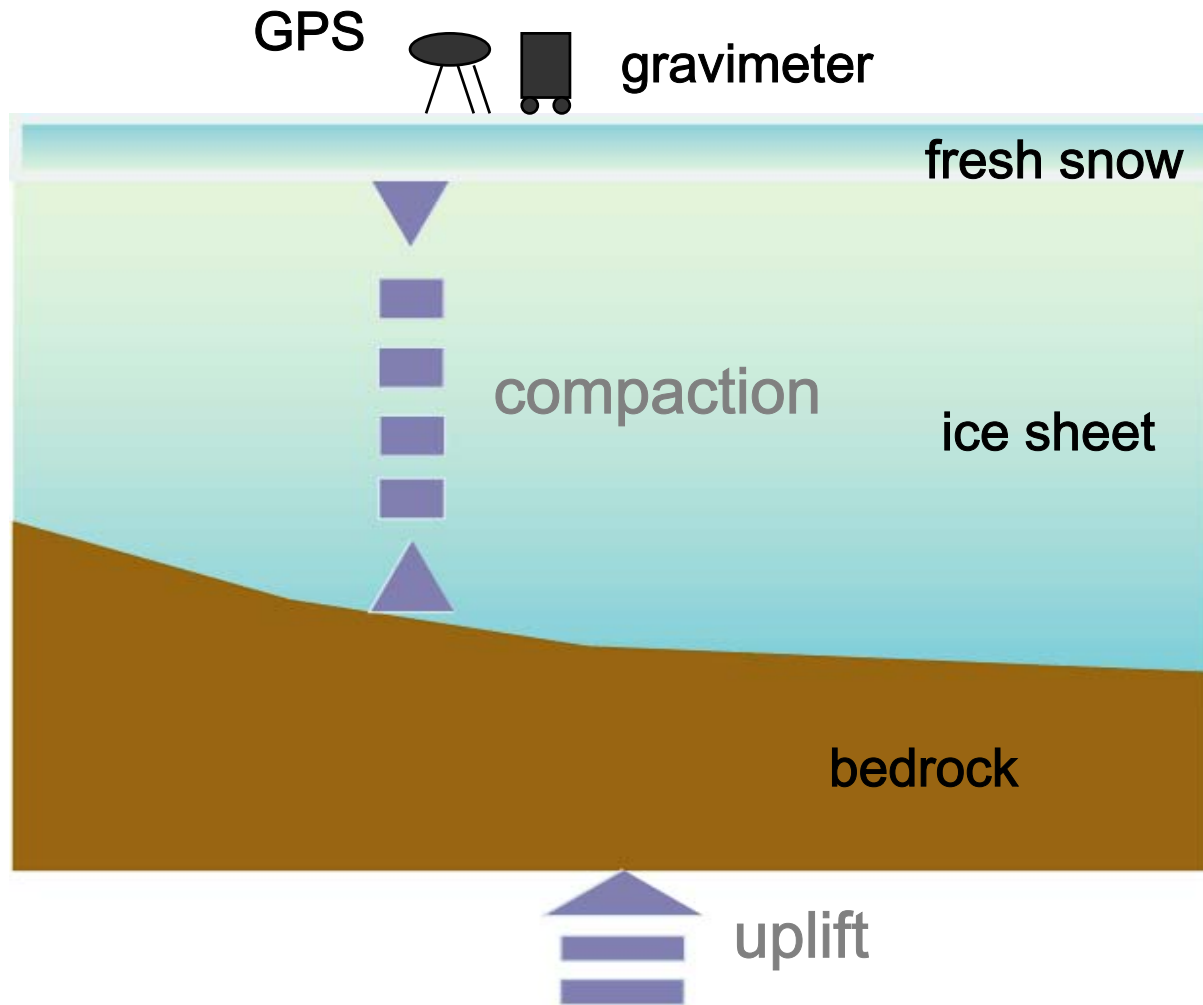

- Gravity Changes
- mass change
- height change
- fresh snow
- accumulation/
ablation
- compaction
- uplift/subsidence
- density changes
- compaction
- loading (negligible)

Precise gravity measurements

